



**CALL NO. 102**

**CONTRACT ID. 201033**

**WARREN COUNTY**

**FED/STATE PROJECT NUMBER NHPP 0651(104)**

**DESCRIPTION I-65**

**WORK TYPE ASPHALT PAVEMENT & ROADWAY REHAB**

**PRIMARY COMPLETION DATE 10/15/2021**

**LETTING DATE: November 20,2020**

Sealed Bids will be received electronically through the Bid Express bidding service until 10:00 am EASTERN STANDARD TIME November 20,2020. Bids will be publicly announced at 10:00 am EASTERN STANDARD TIME.

**NO PLANS ASSOCIATED WITH THIS PROJECT.**

**DBE CERTIFICATION REQUIRED - 10%**

**REQUIRED BID PROPOSAL GUARANTY: Not less than 5% of the total bid.**

## TABLE OF CONTENTS

PART I	SCOPE OF WORK
	<ul style="list-style-type: none"><li>• PROJECT(S), COMPLETION DATE(S), &amp; LIQUIDATED DAMAGES</li><li>• CONTRACT NOTES</li><li>• FEDERAL CONTRACT NOTES</li><li>• ASPHALT MIXTURE</li><li>• DGA BASE</li><li>• INCIDENTAL SURFACING</li><li>• FUEL AND ASPHALT PAY ADJUSTMENT</li><li>• ASPHALT PAVEMENT RIDE QUALITY CAT A</li><li>• COMPACTION OPTION A</li><li>• SPECIAL NOTE(S) APPLICABLE TO PROJECT</li><li>• RIGHT OF WAY CERTIFICATION</li><li>• UTILITY IMPACT &amp; RAIL CERTIFICATION NOTES</li></ul>
PART II	SPECIFICATIONS AND STANDARD DRAWINGS
	<ul style="list-style-type: none"><li>• SPECIFICATIONS REFERENCE</li><li>• SUPPLEMENTAL SPECIFICATION</li></ul>
PART III	EMPLOYMENT, WAGE AND RECORD REQUIREMENTS
	<ul style="list-style-type: none"><li>• FEDERAL-AID CONSTRUCTION CONTRACTS - FHWA 1273</li><li>• NONDISCRIMINATION OF EMPLOYEES</li><li>• EXECUTIVE BRANCH CODE OF ETHICS</li><li>• PROJECT WAGE RATES LOCALITY 1 / FEDERAL</li><li>• NOTICE OF REQUIREMENT FOR AFFIRMATIVE ACTION TO ENSURE EEO WARREN</li></ul>
PART IV	INSURANCE
PART V	BID ITEMS

**PART I**  
**SCOPE OF WORK**

## ADMINISTRATIVE DISTRICT - 03

**CONTRACT ID - 201033**

**NHPP 0651(104)**

**COUNTY - WARREN**

**PCN - DE11400652033**

**NHPP 0651(104)**

I-65 (MP 13.711) ASPHALT PAVEMENT REHAB ON I-65 FROM MP 13.711 TO MP 25.2 IN WARREN COUNTY (MP 25.200), A DISTANCE OF 011.49 MILES.ASPHALT PAVEMENT & ROADWAY REHAB SYP NO. 03-20016.00.  
GEOGRAPHIC COORDINATES LATITUDE 36:52:45.00 LONGITUDE 86:26:44.00

**COMPLETION DATE(S):**

COMPLETED BY 10/15/2021

APPLIES TO ENTIRE CONTRACT

## **CONTRACT NOTES**

### **PROPOSAL ADDENDA**

All addenda to this proposal must be applied when calculating bid and certified in the bid packet submitted to the Kentucky Department of Highways. Failure to use the correct and most recent addenda may result in the bid being rejected.

### **BID SUBMITTAL**

Bidder must use the Department's electronic bidding software. The Bidder must download the bid file located on the Bid Express website ([www.bidx.com](http://www.bidx.com)) to prepare a bid packet for submission to the Department. The bidder must submit electronically using Bid Express.

### **JOINT VENTURE BIDDING**

Joint venture bidding is permissible. All companies in the joint venture must be prequalified in one of the work types in the Qualifications for Bidders for the project. The bidders must get a vendor ID for the joint venture from the Division of Construction Procurement and register the joint venture as a bidder on the project. Also, the joint venture must obtain a digital ID from Bid Express to submit a bid. A joint bid bond of 5% may be submitted for both companies or each company may submit a separate bond of 5%.

### **UNDERGROUND FACILITY DAMAGE PROTECTION**

The contractor shall make every effort to protect underground facilities from damage as prescribed in the Underground Facility Damage Protection Act of 1994, Kentucky Revised Statute KRS 367.4901 to 367.4917. It is the contractor's responsibility to determine and take steps necessary to be in compliance with federal and state damage prevention directives. When prescribed in said directives, the contractor shall submit Excavation Locate Requests to the Kentucky Contact Center (KY811) via web ticket entry. The submission of this request does not relieve the contractor from the responsibility of contacting non-member facility owners, whom shall be contacted through their individual Protection Notification Center. Non-compliance with these directives can result in the enforcement of penalties.

### **REGISTRATION WITH THE SECRETARY OF STATE BY A FOREIGN ENTITY**

Pursuant to KRS 176.085(1)(b), an agency, department, office, or political subdivision of the Commonwealth of Kentucky shall not award a state contract to a person that is a foreign entity required by [KRS 14A.9-010](#) to obtain a certificate of authority to transact business in the Commonwealth ("certificate") from the Secretary of State under [KRS 14A.9-030](#) unless the person produces the certificate within fourteen (14) days of the bid or proposal opening. If the foreign entity is not required to obtain a certificate as provided in [KRS 14A.9-010](#), the foreign entity should identify the applicable exception. Foreign entity is defined within [KRS 14A.1-070](#).

**For all foreign entities required to obtain a certificate of authority to transact business in the Commonwealth, if a copy of the certificate is not received by the contracting agency within the time frame identified above, the foreign entity's solicitation response shall be deemed non-responsive or the awarded contract shall be cancelled.**

Businesses can register with the Secretary of State at <https://secure.kentucky.gov/sos/ftbr/welcome.aspx>.

### **SPECIAL NOTE FOR PROJECT QUESTIONS DURING ADVERTISEMENT**

Questions about projects during the advertisement should be submitted in writing to the Division of Construction Procurement. This may be done by fax (502) 564-7299 or email to [kytc.projectquestions@ky.gov](mailto:kytc.projectquestions@ky.gov). The Department will attempt to answer all submitted questions. The Department reserves the right not to answer if the question is not pertinent or does not aid in clarifying the project intent.

The deadline for posting answers will be 3:00 pm Eastern Daylight Time, the day preceding the Letting. Questions may be submitted until this deadline with the understanding that the later a question is submitted, the less likely an answer will be able to be provided.

The questions and answers will be posted for each Letting under the heading "Questions & Answers" on the Construction Procurement website ([www.transportation.ky.gov/contract](http://www.transportation.ky.gov/contract)). The answers provided shall be considered part of this Special Note and, in case of a discrepancy, will govern over all other bidding documents.

### **HARDWOOD REMOVAL RESTRICTIONS**

The US Department of Agriculture has imposed a quarantine in Kentucky and several surrounding states, to prevent the spread of an invasive insect, the emerald ash borer. Hardwood cut in conjunction with the project may not be removed from the state. Chipping or burning on site is the preferred method of disposal.

### **INSTRUCTIONS FOR EXCESS MATERIAL SITES AND BORROW SITES**

Identification of excess material sites and borrow sites shall be the responsibility of the Contractor. The Contractor shall be responsible for compliance with all applicable state and federal laws and may wish to consult with the US Fish and Wildlife Service to seek protection under Section 10 of the Endangered Species Act for these activities.

### **ACCESS TO RECORDS**

The contractor, as defined in KRS 45A.030 (9) agrees that the contracting agency, the Finance and Administration Cabinet, the Auditor of Public Accounts, and the Legislative Research Commission, or their duly authorized representatives, shall have access to any books, documents, papers, records, or other evidence, which are directly pertinent to this contract for the purpose of financial audit or program review. Records and other prequalification information confidentially

disclosed as part of the bid process shall not be deemed as directly pertinent to the contract and shall be exempt from disclosure as provided in KRS 61.878(1)(c). The contractor also recognizes that any books, documents, papers, records, or other evidence, received during a financial audit or program review shall be subject to the Kentucky Open Records Act, KRS 61.870 to 61.884.

In the event of a dispute between the contractor and the contracting agency, Attorney General, or the Auditor of Public Accounts over documents that are eligible for production and review, the Finance and Administration Cabinet shall review the dispute and issue a determination, in accordance with Secretary's Order 11-004.

April 30, 2018

### **FEDERAL CONTRACT NOTES**

The Kentucky Department of Highways, in accordance with the Regulations of the United States Department of Transportation 23 CFR 635.112 (h), hereby notifies all bidders that failure by a bidder to comply with all applicable sections of the current Kentucky Standard Specifications, including, but not limited to the following, may result in a bid not being considered responsive and thus not eligible to be considered for award:

- |                                |  |
|--------------------------------|--|
| 102.02 Current Rating          | 102.08 Preparation and Delivery of Proposals |
| 102.13 Irregular Bid Proposals | 102.14 Disqualification of Bidders           |
| 102.09 Proposal Guaranty       |  |

### **CIVIL RIGHTS ACT OF 1964**

The Kentucky Department of Highways, in accordance with the provisions of Title VI of the Civil Rights Act of 1964 (78 Stat. 252) and the Regulations of the Federal Department of Transportation (49 C.F.R., Part 21), issued pursuant to such Act, hereby notifies all bidders that it will affirmatively insure that the contract entered into pursuant to this advertisement will be awarded to the lowest responsible bidder without discrimination on the ground of race, color, or national origin.

### **NOTICE TO ALL BIDDERS**

To report bid rigging activities call: 1-800-424-9071.

The U.S. Department of Transportation (DOT) operates the above toll-free "hotline" Monday through Friday, 8:00 a.m. to 5:00 p.m. eastern time. Anyone with knowledge of possible bid rigging, bidder collusion, or other fraudulent activities should use the "hotline" to report such activities.

The "hotline" is part of the DOT's continuing effort to identify and investigate highway construction contract fraud and abuse and is operated under the direction of the DOT Inspector General. All information will be treated confidentially and caller anonymity will be respected.

### **SECOND TIER SUBCONTRACTS**

Second Tier subcontracts on federally assisted projects shall be permitted. However, in the case of DBE's, second tier subcontracts will only be permitted where the other subcontractor is also a DBE. All second tier subcontracts shall have the consent of both the Contractor and the Engineer.

### **DISADVANTAGED BUSINESS ENTERPRISE PROGRAM**

It is the policy of the Kentucky Transportation Cabinet (“the Cabinet”) that Disadvantaged Business Enterprises (“DBE”) shall have the opportunity to participate in the performance of highway construction projects financed in whole or in part by Federal Funds in order to create a level playing field for all businesses who wish to contract with the Cabinet. To that end, the Cabinet will comply with the regulations found in 49 CFR Part 26, and the definitions and requirements contained therein shall be adopted as if set out verbatim herein.

The Cabinet, contractors, subcontractors, and sub-recipients shall not discriminate on the basis of race, color, national origin, or sex in the performance of work performed pursuant to Cabinet contracts. The contractor shall carry out applicable requirements of 49 CFR 26 in the award and administration of federally assisted highway construction projects. The contractor will include this provision in all its subcontracts and supply agreements pertaining to contracts with the Cabinet.

Failure by the contractor to carry out these requirements is a material breach of its contract with the Cabinet, which may result in the termination of the contract or such other remedy as the Cabinet deems necessary.

### **DBE GOAL**

The Disadvantaged Business Enterprise (DBE) goal established for this contract, as listed on the front page of the proposal, is the percentage of the total value of the contract.

The contractor shall exercise all necessary and reasonable steps to ensure that Disadvantaged Business Enterprises participate in a least the percent of the contract as set forth above as goals for this contract.

### **OBLIGATION OF CONTRACTORS**

Each contractor prequalified to perform work on Cabinet projects shall designate and make known to the Cabinet a liaison officer who is assigned the responsibility of effectively administering and promoting an active program for utilization of DBEs.

If a formal goal has not been designated for the contract, all contractors are encouraged to consider DBEs for subcontract work as well as for the supply of material and services needed to perform this work.

Contractors are encouraged to use the services of banks owned and controlled by minorities and women.

### **CERTIFICATION OF CONTRACT GOAL**

Contractors shall include the following certification in bids for projects for which a DBE goal has been established. BIDS SUBMITTED WHICH DO NOT INCLUDE CERTIFICATION OF DBE PARTICIPATION WILL NOT BE ACCEPTED. These bids will not be considered for award by the Cabinet and they will be returned to the bidder.

“The bidder certifies that it has secured participation by Disadvantaged Business Enterprises (“DBE”) in the amount of \_\_\_\_\_ percent of the total value of this contract and that the DBE participation is in compliance with the requirements of 49 CFR 26 and the policies of the Kentucky Transportation Cabinet pertaining to the DBE Program.”

**The certification statement is located in the electronic bid file. All contractors must certify their DBE participation on that page. DBEs utilized in achieving the DBE goal must be certified and prequalified for the work items at the time the bid is submitted.**

### **DBE PARTICIPATION PLAN**

Lowest responsive bidders must submit the *DBE Plan/ Subcontractor Request*, form TC 14-35 DBE, within **5** days of the letting. This is necessary before the Awards Committee will review and make a recommendation. **The project will not be considered for award prior to submission and approval of the apparent low bidder’s DBE Plan/Subcontractor Request.**

The DBE Participation Plan shall include the following:

1. Name and address of DBE Subcontractor(s) and/or supplier(s) intended to be used in the proposed project;
2. Description of the work each is to perform including the work item, unit, quantity, unit price and total amount of the work to be performed by the individual DBE. The Proposal Line Number, Category Number, and the Project Line Number can be found in the “material listing” on the Construction Procurement website under the specific letting;
3. The dollar value of each proposed DBE subcontract and the percentage of total project contract value this represents. DBE participation may be counted as follows:
  - a. If DBE suppliers and manufactures assume actual and contractual responsibility, the dollar value of materials to be furnished will be counted toward the goal as follows:
    - The entire expenditure paid to a DBE manufacturer;
    - 60 percent of expenditures to DBE suppliers that are not manufacturers provided the supplier is a regular dealer in the product involved. A regular dealer must be engaged in, as its principal business and in its own name, the sale of products to the public, maintain an inventory and own and operate distribution equipment; and
    - The amount of fees or commissions charged by the DBE firms for a bona fide service, such as professional, technical, consultant, or managerial services and assistance in the procurement of essential personnel, facilities, equipment, materials, supplies, delivery of materials and supplies or for furnishing bonds, or insurance, providing such fees or commissions are determined to be reasonable and customary.

- b) The dollar value of services provided by DBEs such as quality control testing, equipment repair and maintenance, engineering, staking, etc.;
  - c) The dollar value of joint ventures. DBE credit for joint ventures will be limited to the dollar amount of the work actually performed by the DBE in the joint venture;
4. Written and signed documentation of the bidder's commitment to use a DBE contractor whose participation is being utilized to meet the DBE goal; and
  5. Written and signed confirmation from the DBE that it is participating in the contract as provided in the prime contractor's commitment.

#### **UPON AWARD AND BEFORE A WORK ORDER WILL BE ISSUED**

Contractors must submit the signed subcontract between the contractor and the DBE contractor, along with the DBE's certificate of insurance. If the DBE is a supplier of materials for the project, a signed purchase order must be submitted to the Division of Construction Procurement.

Changes to DBE Participation Plans must be approved by the Cabinet. The Cabinet may consider extenuating circumstances including, but not limited to, changes in the nature or scope of the project, the inability or unwillingness of a DBE to perform the work in accordance with the bid, and/or other circumstances beyond the control of the prime contractor.

#### **CONSIDERATION OF GOOD FAITH EFFORTS REQUESTS**

If the DBE participation submitted in the bid by the apparent lowest responsive bidder does not meet or exceed the DBE contract goal, the apparent lowest responsive bidder must submit a Good Faith Effort Package to satisfy the Cabinet that sufficient good faith efforts were made to meet the contract goals prior to submission of the bid. Efforts to increase the goal after bid submission will not be considered in justifying the good faith effort, unless the contractor can show that the proposed DBE was solicited prior to the letting date. DBEs utilized in achieving the DBE goal must be certified and prequalified for the work items at the time the bid is submitted. One complete set (hard copy along with an electronic copy) of this information must be received in the Division of Contract Procurement no later than 12:00 noon of the tenth calendar day after receipt of notification that they are the apparent low bidder.

Where the information submitted includes repetitious solicitation letters it will be acceptable to submit a sample representative letter along with a distribution list of the firms solicited. Documentation of DBE quotations shall be a part of the good faith effort submittal as necessary to demonstrate compliance with the factors listed below which the Cabinet considers in judging good faith efforts. This documentation may include written subcontractors' quotations, telephone log notations of verbal quotations, or other types of quotation documentation.

The Good Faith Effort Package shall include, but may not be limited to information showing evidence of the following:

1. Whether the bidder attended any pre-bid meetings that were scheduled by the Cabinet to inform DBEs of subcontracting opportunities;
2. Whether the bidder provided solicitations through all reasonable and available means;
3. Whether the bidder provided written notice to all DBEs listed in the DBE directory at the time of the letting who are prequalified in the areas of work that the bidder will be subcontracting;
4. Whether the bidder followed up initial solicitations of interest by contacting DBEs to determine with certainty whether they were interested. If a reasonable amount of DBEs within the targeted districts do not provide an intent to quote or no DBEs are prequalified in the subcontracted areas, the bidder must notify the Disadvantaged Enterprise Business Liaison Officer (DEBLO) in the Office of Civil Rights and Small Business Development to give notification of the bidder's inability to get DBE quotes;
5. Whether the bidder selected portions of the work to be performed by DBEs in order to increase the likelihood of meeting the contract goals. This includes, where appropriate, breaking out contract work items into economically feasible units to facilitate DBE participation, even when the prime contractor might otherwise perform these work items with its own forces;
6. Whether the bidder provided interested DBEs with adequate and timely information about the plans, specifications, and requirements of the contract;
7. Whether the bidder negotiated in good faith with interested DBEs not rejecting them as unqualified without sound reasons based on a thorough investigation of their capabilities. Any rejection should be so noted in writing with a description as to why an agreement could not be reached;
8. Whether quotations were received from interested DBE firms but were rejected as unacceptable without sound reasons why the quotations were considered unacceptable. The fact that the DBE firm's quotation for the work is not the lowest quotation received will not in itself be considered as a sound reason for rejecting the quotation as unacceptable. The fact that the bidder has the ability and/or desire to perform the contract work with its own forces will not be considered a sound reason for rejecting a DBE quote. Nothing in this provision shall be construed to require the bidder to accept unreasonable quotes in order to satisfy DBE goals;
9. Whether the bidder specifically negotiated with subcontractors to assume part of the responsibility to meet the contract DBE goal when the work to be subcontracted includes potential DBE participation;
10. Whether the bidder made any efforts and/or offered assistance to interested DBEs in obtaining the necessary equipment, supplies, materials, insurance and/or bonding to satisfy the work requirements of the bid proposal; and
11. Any other evidence that the bidder submits which may show that the bidder has made reasonable good faith efforts to include DBE participation.

### **FAILURE TO MEET GOOD FAITH REQUIREMENT**

Where the apparent lowest responsive bidder fails to submit sufficient participation by DBE firms to meet the contract goal and upon a determination by the Good Faith Committee based upon the information submitted that the apparent lowest responsive bidder failed to make sufficient reasonable efforts to meet the contract goal, the bidder will be offered the opportunity to meet in person for administrative reconsideration. The bidder will be notified of the Committee's decision within 24 hours of its decision. The bidder will have 24 hours to request reconsideration of the Committee's decision. The reconsideration meeting will be held within two days of the receipt of a request by the bidder for reconsideration.

The request for reconsideration will be heard by the Office of the Secretary. The bidder will have the opportunity to present written documentation or argument concerning the issue of whether it met the goal or made an adequate good faith effort. The bidder will receive a written decision on the reconsideration explaining the basis for the finding that the bidder did or did not meet the goal or made adequate Good Faith efforts to do so.

The result of the reconsideration process is not administratively appealable to the Cabinet or to the United States Department of Transportation.

The Cabinet reserves the right to award the contract to the next lowest responsive bidder or to rebid the contract in the event that the contract is not awarded to the low bidder as the result of a failure to meet the good faith requirement.

### **SANCTIONS FOR FAILURE TO MEET DBE REQUIREMENTS OF THE PROJECT**

Failure by the prime contractor to fulfill the DBE requirements of a project under contract or to demonstrate good faith efforts to meet the goal constitutes a breach of contract. When this occurs, the Cabinet will hold the prime contractor accountable, as would be the case with all other contract provisions. Therefore, the contractor's failure to carry out the DBE contract requirements shall constitute a breach of contract and as such the Cabinet reserves the right to exercise all administrative remedies at its disposal including, but not limited to the following:

- Disallow credit toward the DBE goal;
- Withholding progress payments;
- Withholding payment to the prime in an amount equal to the unmet portion of the contract goal; and/or
- Termination of the contract.

### **PROMPT PAYMENT**

The prime contractor will be required to pay the DBE within seven (7) working days after he or she has received payment from the Kentucky Transportation Cabinet for work performed or materials furnished.

### **CONTRACTOR REPORTING**

All contractors must keep detailed records and provide reports to the Cabinet on their progress in meeting the DBE requirement on any highway contract. These records may include, but shall not be limited to payroll, lease agreements, cancelled payroll checks, executed subcontracting agreements, etc. Prime contractors will be required to complete and submit a **signed and notarized** Affidavit of Subcontractor Payment (TC 18-7) and copies of checks for any monies paid to each DBE subcontractor or supplier utilized to meet a DBE goal. These documents must be completed and signed within 7 days of being paid by the Cabinet.

Payment information that needs to be reported includes date the payment is sent to the DBE, check number, Contract ID, amount of payment and the check date. Before Final Payment is made on this contract, the Prime Contractor will certify that all payments were made to the DBE subcontractor and/or DBE suppliers.

**\*\*\*\*\* IMPORTANT \*\*\*\*\***

**Please mail the original, signed and completed TC (18-7) Affidavit of Subcontractor Payment form and all copies of checks for payments listed above to the following address:**

Office of Civil Rights and Small Business Development  
6<sup>th</sup> Floor West 200 Mero Street  
Frankfort, KY 40622

The prime contractor should notify the KYTC Office of Civil Rights and Small Business Development seven (7) days prior to DBE contractors commencing work on the project. The contact in this office is Mr. Melvin Bynes. Mr. Bynes' current contact information is email address – [melvin.bynes2@ky.gov](mailto:melvin.bynes2@ky.gov) and the telephone number is (502) 564-3601.

### **DEFAULT OR DECERTIFICATION OF THE DBE**

If the DBE subcontractor or supplier is decertified or defaults in the performance of its work, and the overall goal cannot be credited for the uncompleted work, the prime contractor may utilize a substitute DBE or elect to fulfill the DBE goal with another DBE on a different work item. If after exerting good faith effort in accordance with the Cabinet's Good Faith Effort policies and procedures, the prime contractor is unable to replace the DBE, then the unmet portion of the goal may be waived at the discretion of the Cabinet.

### **PROHIBITION ON TELECOMMUNICATIONS EQUIPMENT OR SERVICES**

In accordance with the FY 2019 National Defense Authorization Act (NDAA), 2 CFR 200.216, and 2 CFR 200.471, Federal agencies are prohibited, after August 13, 2020, from obligating or expending financial assistance to obtain certain telecommunications and video surveillance services and equipment from specific producers. As a result of these regulations, contractors and subcontractors are prohibited, on projects with federal funding participation, from providing telecommunication or video surveillance equipment, services, or systems produced by:

- Huawei Technologies Company or ZTE Corporation (or any subsidiary or affiliate of such entities)
- Hytera Communications Corporation, Hangzhou Hikvision Digital Technology Company, or Dahua Technology Company (or any subsidiary or affiliate of such entities)

**LEGAL REQUIREMENTS AND RESPONSIBILITY TO THE PUBLIC – CARGO PREFERENCE ACT (CPA).**

**(REV 12-17-15) (1-16)**

SECTION 7 is expanded by the following new Article:

102.10 **Cargo Preference Act – Use of United States-flag vessels.**

Pursuant to Title 46CFR Part 381, the Contractor agrees

- To utilize privately owned United States-flag commercial vessels to ship at least 50 percent of the gross tonnage (computed separately for dry bulk carriers, dry cargo liners, and tankers) involved, whenever shipping any equipment, material, or commodities pursuant to this contract, to the extent such vessels are available at fair and reasonable rates for United States-flag commercial vessels.

- To furnish within 20 days following the date of loading for shipments originating within the United States or within 30 working days following the date of loading for shipments originating outside the United States, a legible copy of a rated, 'on-board' commercial ocean bill-of-lading in English for each shipment of cargo described in paragraph 1 of this section to both the Contracting Officer (through the prime contractor in the case of subcontractor bills-of-lading) and to the Division of National Cargo, Office of Market Development, Maritime Administration, Washington, DC 20590.

- To insert the substance of the provisions of this clause in all subcontracts issued pursuant to this contract.

### **ASPHALT MIXTURE**

Unless otherwise noted, the Department estimates the rate of application for all asphalt mixtures to be 110 lbs/sy per inch of depth.

### **DGA BASE**

Unless otherwise noted, the Department estimates the rate of application for DGA Base to be 115 lbs/sy per inch of depth.

### **INCIDENTAL SURFACING**

The Department has included in the quantities of asphalt mixtures established in the proposal estimated quantities required for resurfacing or surfacing mailbox turnouts, farm field entrances, residential and commercial entrances, curve widening, ramp gores and tapers, and road and street approaches, as applicable. Pave these areas to the limits as shown on Standard Drawing RPM-110-06 or as directed by the Engineer. In the event signal detectors are present in the intersecting streets or roads, pave the crossroads to the right of way limit or back of the signal detector, whichever is the farthest back of the mainline. Surface or resurface these areas as directed by the Engineer. The Department will not measure placing and compacting for separate payment but shall be incidental to the Contract unit price for the asphalt mixtures.

### **FUEL AND ASPHALT PAY ADJUSTMENT**

The Department has included the Contract items Asphalt Adjustment and Fuel Adjustment for possible future payments at an established Contract unit price of \$1.00. The Department will calculate actual adjustment quantities after work is completed. If existing Contract amount is insufficient to pay all items on the contract with the adjustments, the Department will establish additional monies with a change order.

### **ASPHALT PAVEMENT RIDE QUALITY CATEGORY A**

The Department will apply Pavement Rideability Requirements on this project in accordance with Section 410, Category A.

### **OPTION A**

Be advised that the Department will accept compaction of asphalt mixtures furnished for driving lanes and ramps, at 1 inch (25mm) or greater, on this project according to OPTION A in accordance with Section 402 and Section 403 of the current Standard Specifications. The Department will require joint cores as described in Section 402.03.02 for surface mixtures only. The Department will accept compaction of all other asphalt mixtures according to OPTION B.

# Commonwealth of Kentucky DEPARTMENT OF HIGHWAYS

## I-65

### ASPHALT PAVEMENT AND ROADWAY REHABILITATION

**WARREN COUNTY - MP 13.711 - MP 25.200  
ITEM NO. 03-20016.00**

#### **TABLE OF CONTENTS**

- LAYOUT SHEET
- LIST OF STANDARD DRAWINGS
- REFERENCES
- GENERAL NOTES
- GENERAL SUMMARY
- PAVEMENT AREAS
- PAVEMENT SUMMARY
- PAVEMENT REPAIR SUMMARY
- DRAINAGE REPAIR SUMMARY
- EROSION REPAIR SUMMARY
- TYPICAL SECTIONS
- PLAN SHEETS
- PAVEMENT REPAIR DETAILS
- EROSION REPAIR DETAILS
- BARRIER WALL MOUNTING DETAIL FOR SIGNING
- TRAFFIC CONTROL PLAN
- TYPICAL SECTIONS FOR MAINTENANCE OF TRAFFIC
- NATCHER INTERCHANGE PLAN FOR MAINTENANCE OF TRAFFIC
- APPLICABLE SPECIAL NOTES
- PERMANENT TRAFFIC DATA ACQUISITION STATIONS DETAILS

Prepared By:  
WSP USA INC.  
1792 ALYSHEBA WAY  
LEXINGTON, KY 40509  
859-272-5400

October 2, 2020

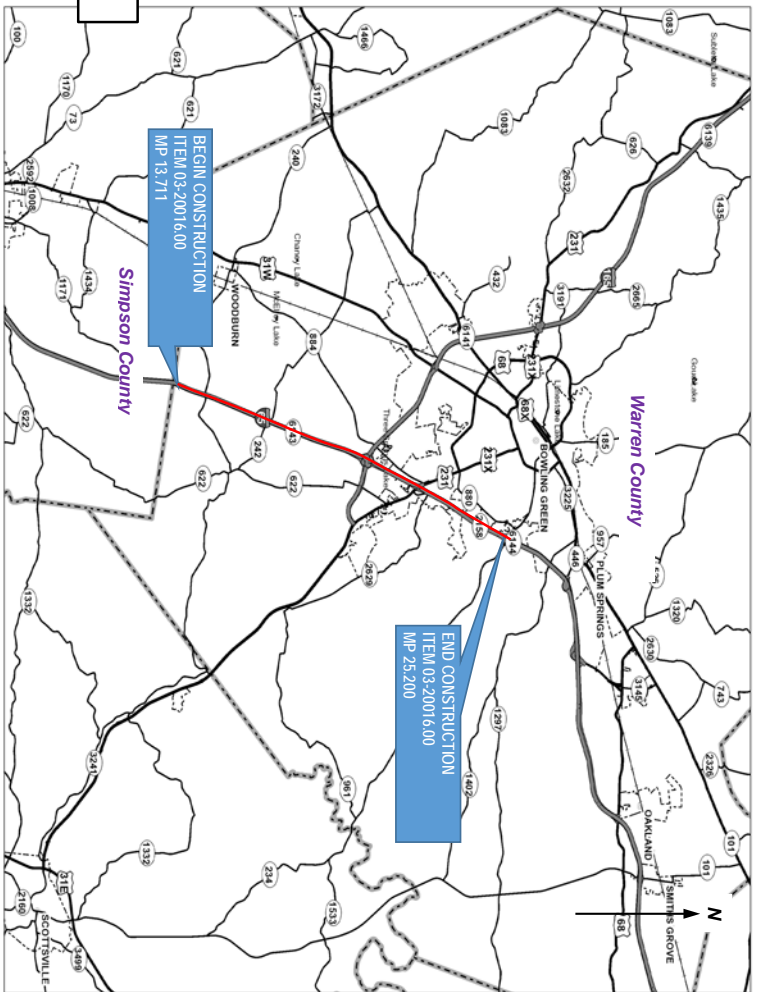
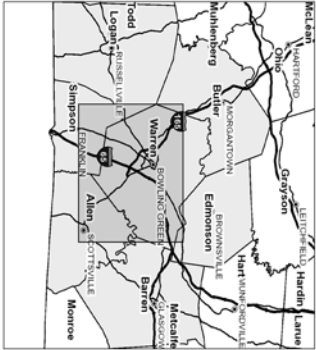
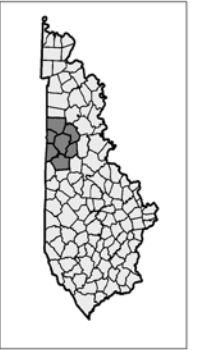

THIS PROJECT IS A FULLY CONTROLLED ACCESS HIGHWAY

COUNTY(S): Warren

ITEM NO(S): 03-20016.00

PROJECT NO(S): FD52 114 0065 013-026, NHPP 0651(104)

LETTING DATE: 11/22/2020

RECOMMENDED BY:

KYTC Project Manager

DATE:

PLAN APPROVED BY:

State Highway Engineer

DATE:

FHWA APPROVED BY:

DATE:

**STANDARD DRAWINGS  
I-65 - WARREN COUNTY  
PAGE 1 OF 1**

APPLICABLE KENTUCKY DEPARTMENT OF HIGHWAYS STANDARD  
DRAWINGS - CURRENT EDITIONS:

RBE-100	CRASH CUSHION TYPE VI-BT
RBI-001	TYPICAL GUARDRAIL INSTALLATIONS
RBI-002	TYPICAL GUARDRAIL INSTALLATIONS
RBI-003	TYPICAL INSTALLATION FOR GUARDRAIL END TREATMENT TYPE 2A
RBI-004	INSTALLATION OF GUARDRAIL END TREATMENT TYPE 1
RBI-005	GUARDRAIL INSTALLATION AT BRIDGE COLUMNS
RBM-020	DELINEATORS FOR CONCRETE BARRIER
RBM-115	CONCRETE BARRIER WALL 9T (TEMPORARY)
RBM-120	BOX BEAM STIFFENING PF TEMPORARY CONCRETE BARRIER
RBR-001	STEEL BEAM GUARDRAIL ("W" BEAM)
RBR-005	GUARDRAIL COMPONENTS
RBR-010	GUARDRAIL TERMINAL SECTIONS
RBR-015	STEEL GUARDRAIL POSTS
RBR-020	GUARDRAIL END TREATMENT TYPE 1
RBR-025	GUARDRAIL END TREATMENT TYPE 2A
RBR-055	DELINEATORS FOR GUARDRAIL
RDB-101	GRATES FOR SLOPED BOX OUTLET TYPE 1
RDD-040	CHANNEL LINING CLASS II AND III
RDI-040	EROSION CONTROL BLANKET SLOPE INSTALLATION
RDI-041	EROSION CONTROL BLANKET CHANNEL INSTALLATION
RGX-001	CURVE WIDENING AND SUPERLEVATION TRANSITIONS
TPM-105	PAVEMENT MARKER ARRANGEMENTS MULTI-LANE ROADWAYS
TPM-125	PAVEMENT MARKER ARRANGEMENT EXIT GORE AND OFF-RAMP
TPM-126	PAVEMENT MARKER ARRANGEMENT FOR PARALLEL DECELERATION LANE
TPM-130	PAVEMENT MARKER ARRANGEMENT ON-RAMP WITH TAPERED ACCELERATION LANE
TPM-135	PAVEMENT MARKER ARRANGEMENT ON-RAMP WITH PARALLEL ACCELERATION LANE
TPM-200	TYPICAL ENTRANCE RAMP MARKINGS FOR INTERSTATES AND PARKWAYS
TPM-201	TYPICAL EXIT RAMP MARKINGS FOR INTERSTATES AND PARKWAYS
TPM-202	TYPICAL EXIT RAMP MARKINGS FOR INTERSTATES AND PARKWAYS
TPR-115	SHOULDER & EDGLINE RUMBLE STRIP PLACEMENT DETAILS
TPR-130	RUMBLE STRIP DETAILS MULTI-LANE ROADWAYS AND RAMPS
TTC-115	LANE CLOSURE MULTI-LANE HIGHWAY CASE I
TTC-120	LANE CLOSURE MULTI-LANE HIGHWAY CASE II
TTD-120	DOUBLE FINE ZONES SIGNS
TTD-130	SPEED ZONE WARNING SIGNS
TTS-125	MOBILE OPERATION FOR DURABLE STRIPING CASE II

**REFERENCES**  
**I-65 - WARREN COUNTY**  
**PAGE 1 OF 1**

1. KENTUCKY TRANSPORTATION CABINET, DEPARTMENT OF HIGHWAYS, STANDARD SPECIFICATIONS FOR ROAD AND BRIDGE CONSTRUCTION, CURRENT EDITION.

2. FHWA MANUAL ON UNIFORM TRAFFIC CONTROL DEVICES (MUTCD)  
- CURRENT EDITION WITH REVISIONS.

3. APPLICABLE KENTUCKY DEPARTMENT OF HIGHWAYS SUPPLEMENT SPECIFICATIONS:

SPCL. NOTE	ASPHALT MILLING AND TEXTURING
SPCL. NOTE	TYPICAL SECTION DIMENSIONS
SPCL. NOTE	BEFORE YOU DIG
SPCL. NOTE	FIXED COMPLETION DATE AND LIQUIDATED DAMAGES
SPCL. NOTE	FOG SEAL
SPCL. NOTE	GUARDRAIL DELIVERY VERIFICATION SHEET
SPCL. NOTE	BARCODE LABEL ON PERMANENT SIGNS
SPCL. NOTE	LONGITUDINAL PAVEMENT JOINT ADHESIVE
SPCL. NOTE	NON-TRACKING TACK COAT
SPCL. NOTE	HMA ELECTRONIC DELIVERY MANAGEMENT SYSTEM
SPCL. NOTE	EXPERIMENTAL KYCT AND HAMBURG TESTING

GENERAL SUMMARY							
I-65 - WARREN COUNTY - ITEM NO. 03-20016.00							
BID CODE	ITEM	UNIT	NOTES	QUANTITIES			
				I-65	US 231 RAMP	NB C-D ROAD	TOTALS
00001	DGA BASE	TON	12,14	93			93
00078	CRUSHED AGGREGATE SIZE NO 2	TON		1,264			1,264
00100	ASPHALT SEAL AGGREGATE	TON		1,063	58		1,121
00103	ASPHALT SEAL COAT	TON		128	7		135
00194	LEVELING AND WEDGING PG76-22	TON		3,258	81	8	3,347
00336	CL3 ASPH SURF 0.38A PG76-22	TON			2,444	252	2,696
00342	CL4 ASPH SURF 0.38A PG76-22	TON		52,426			52,426
01982	DELINEATOR FOR GUARDRAIL M/W	EACH	12	5			5
01985	DELINEATOR FOR BARRIER - YELLOW	EACH	4	300			300
02003	RELOCATE TEMP CONC BARRIER	LF	8	7,000			7,000
02165	REMOVE PAVED DITCH	SQYD		2,172			2,172
02351	GUARDRAIL-STEEL W BEAM-S FACE	LF	12	343			343
02367	GUARDRAIL END TREATMENT TYPE 1	EACH	12	1			1
02369	GUARDRAIL END TREATMENT TYPE 2A	EACH	12	1			1
02381	REMOVE GUARDRAIL	LF	12	404			404
02483	CHANNEL LINING CLASS II	TON		497			497
02562	TEMPORARY SIGNS	SQFT	3	3,500	300	200	4,000
02568	MOBILIZATION	LS					1
02569	DEMOBILIZATION	LS					1
02575	DITCHING AND SHOULDERING	LF		69,460	7,755		77,215
02650	MAINTAIN AND CONTROL TRAFFIC	LS					1
02671	PORTABLE CHANGEABLE MESSAGE SIGN	EACH	3	4			4
02676	MOBILIZATION FOR MILL & TEXT	LS					1
02677	ASPHALT PAVE MILLING AND TEXTURING	TON		52,426	2,444	252	55,122
02696	SHOULDER RUMBLE STRIPS	LF		237,140	11,256	2,500	250,896
02726	STAKING	LS	13				1
02775	ARROW PANEL	EACH	3	6			6
02898	RELOCATE CRASH CUSHION	EACH	8	35			35
03171	CONCRETE BARRIER WALL TYPE 9T	LF	8	2,000			2,000
03240	BASE FAILURE REPAIR	SQYD	8	1,440			1,440
04793	CONDUIT 1 1/4 INCH	LF	7	200			200

GENERAL SUMMARY							
I-65 - WARREN COUNTY - ITEM NO. 03-20016.00							
BID CODE	ITEM	UNIT	NOTES	QUANTITIES			
				I-65	US 231 RAMP	NB C-D ROAD	TOTALS
04795	CONDUIT 2 INCH	LF	7	140			140
04820	TRENCHING AND BACKFILLING	LF	7	320			320
04829	PIEZOELECTRIC SENSOR	EACH	7	26			26
04830	LOOP WIRE	LF	7	15,050			15,050
04895	LOOP SAW SLOT AND FILL	LF	7	2,030			2,030
04904	BARRIER MOUNTING BRACKET	EACH	4,10	5			5
05950	EROSION CONTROL BLANKET	SQYD	11				60,000
06407	SBM ALUM SHEET SIGNS .125 IN	SF	10	870			870
06511	PAVE STRIPING-TEMP PAINT-6 IN	LF	3	304,810			304,810
06542	PAVE STRIPING-THERMO-6 IN W	LF		183,782	9,948	1,250	194,980
06543	PAVE STRIPING-THERMO-6 IN Y	LF		120,939	2,989	1,250	125,178
06546	PAVE STRIPING-THERMO-12 IN W	LF		4,078	1,138		5,216
06549	PAVE STRIPING-TEMP REM TAPE-B	LF	2,3	1,700			1,700
06550	PAVE STRIPING-TEMP REM TAPE-W	LF	2,3	3,600			3,600
06551	PAVE STRIPING-TEMP REM TAPE-Y	LF	2,3	1,700			1,700
06574	PAVE MARKING-THERMO CURV ARROW	EACH			12		12
06578	PAVE MARKING-THERMO MERGE ARROW	EACH			6		6
08903	CRASH CUSHION TY VI CLASS BT TL3	EACH	8	10			10
10020NS	FUEL ADJUSTMENT	DOLL					89,279
10030NS	ASPHALT ADJUSTMENT	DOLL					224,243
20071EC	JOINT ADHESIVE	LF		248,456	17,105	2,500	268,061
20359NN	GALVANIZED STEEL CABINET	EACH	7	4			4
20360ES818	WOOD POST	EACH	7	8			8
20366NN	REPLACE GRATE	EACH		28			28
20391NS835	ELECTRICAL JUNCTION BOX TYPE A	EACH	7	9			9
20757ED	PAVEMENT REPAIR	SQYD		1,105			1,105
22520EN	PAVE MARKING-THERMO YIELD BAR-36 IN	LF			32		32
24489EC	INLAID PAVEMENT MARKER	EACH		3,446	270		3,716
24631EC	BARCODE SIGN INVENTORY	EACH	10	116			116
24640ED	OBJECT MARKER TYPE 1	EACH	6	10			10
24878EC	ASPHALT EMULSION FOR FOG SEAL	TON		142			142

GENERAL SUMMARY							
I-65 - WARREN COUNTY - ITEM NO. 03-20016.00							
BID CODE	ITEM	UNIT	NOTES	QUANTITIES			
				I-65	US 231 RAMP	NB C-D ROAD	TOTALS
24970EC	ASPHALT MATERIAL FOR TACK NON-TRACKING	TON		202	10		212
24986EC	HMA ELECTRONIC MGMT SYSTEM	LS					1

NOTES:

1. Quantities from all other summary sheets have been carried over and included in this General Summary Sheet.
2. For traffic tapers at the ends of project.
3. For maintenance of traffic.
4. For damaged mile marker sign's barrier mounting bracket.
5. For replacing any damaged existing barrier wall delineators. It is assumed 25% to be replaced.
6. For crash cushions.
7. For replacing traffic data acquisition stations.
8. For Major Blow Up Pavement Repairs. Quantities based on 5 repairs, each direction, being constructed concurrently.
9. Ditching and Shouldering (Special) includes all excavation and backfill necessary for fill slope erosion.
10. For replacing mile marker signs.
11. For use during Ditching and Shouldering, as directed by the Engineer.
12. For removing and replacing existing guardrail at northbound MP 14.801 to MP 14.877.
13. Includes checking and verifying cross slopes in superelevation transition areas. See General Notes.
14. Estimated at 2.07 tons per cu. yd.

PAVING AREAS						
I-65 - WARREN COUNTY - ITEM NO. 03-20016.00						
BID CODE	ITEM	NOTES	DEPTH (inches)	SQUARE YARDS		
				I-65	US 231 RAMPS	NB C-D ROAD
00100	ASPHALT SEAL AGGREGATE	2	----	53,172	2,904	
00103	ASPHALT SEAL COAT	2	----	53,172	2,904	
00194	LEVELING AND WEDGING PG76-22	3	0.50	57,826	2,962	306
00194	LEVELING AND WEDGING PG76-23	4	1.50	20,221		
00336	CL3 ASPH SURF 0.38A PG76-22		1.50		29,619	3,056
00342	CL4 ASPH SURF 0.38A PG76-22		1.50	578,257		
02677	ASPHALT MILLING AND TEXTURING		----	578,257	29,619	3,056
24878EC	ASPHALT EMULSION FOR FOG SEAL	1	----	242,082		
24970EC	ASPHALT MATERIAL FOR TACK NON-TRACKING			578,257	29,619	3,056

NOTES:

1. For existing paved shoulders not being milled and overlaid.
2. For shoulders without existing guardrail.
3. For areas that experience scabbing after pavement is milled, and for any settlement of pavement and base failure repairs. It is assumed to be 10% of area being milled.
4. For filling in rumble strips for traffic control.

PAVING SUMMARY							
I-65 - WARREN COUNTY - ITEM NO. 03-20016.00							
BID CODE	ITEM	NOTES	UNIT	I-65	US 231 RAMP	NB C-D ROAD	TOTALS
00100	ASPHALT SEAL AGGREGATE	3,6	TON	1,063	58		1,121
00103	ASPHALT SEAL COAT	4,6	TON	128	7		135
00194	LEVELING AND WEDGING PG76-22	2,8	TON	3,258	81	8	3,347
00336	CL3 ASPH SURF 0.38A PG76-22	2	TON		2,444	252	2,696
00342	CL4 ASPH SURF 0.38A PG76-22	2	TON	52,426			52,426
02677	ASPHALT MILLING & TEXTURING	2	TON	52,426	2,444	252	55,122
20071EC	JOINT ADHESIVE		LF	248,456	17,105	2,500	268,061
24878EC	ASPHALT EMULSION FOR FOG SEAL	1,9	TON	142			142
24970EC	ASPHALT MATERIAL FOR TACK NON-TRACKING	5	TON	202	10	1	213

NOTES:

1. For existing paved shoulders not being milled and overlaid.
2. Estimated at 110 lbs. per sq. yd. per inch of depth.
3. Estimated at 20 lbs. per sq. yd. (two applications).
4. Estimated at 2.4 lbs. per sq. yd. (two applications).
5. Estimated at 0.70 lbs. per sq. yd.
6. For shoulders without existing guardrail.
7. Quantities are carried over and included in General Summary.
8. For areas that experience scabbing after pavement is milled and filling in rumble strips for MOT.
9. Estimated at 1.18 lbs per sq.yd.

<b>SCHEDULE AND SUMMARY OF MAJOR AND MINOR PAVEMENT REPAIRS</b>					
<b>I-65 - WARREN COUNTY - ITEM NO. 03-20016.00</b>					
<b>APPROXIMATE LOCATION</b>				<b>MAJOR BLOW UP PAVEMENT REPAIR BID ITEM 03240 (sq. yd.)</b>	<b>MINOR (BLOW UP) PAVEMENT REPAIR DETAIL BID ITEM 20757ED (sq. yd.)</b>
<b>I-65</b>	<b>DIRECTION</b>	<b>STATION</b>	<b>MILEPOINT</b>		
X	NB	35+99	14.393		21.3
X	NB	44+14	14.547	32.0	
X	SB	53+17	14.719	32.0	
X	NB	59+84	14.845	32.0	
X	NB	75+42	15.121	32.0	
X	SB	89+57	15.389	32.0	
X	SB	91+67	15.429	32.0	
X	SB	127+86	16.114		21.3
X	NB	140+22	16.349		21.3
X	SB	142+37	16.389		21.3
X	NB	150+42	16.542		21.3
X	SB	155+40	16.636		21.3
X	NB	158+42	16.686	32.0	
X	NB	160+36	16.730	32.0	
X	NB	180+58	17.113		21.3
X	SB	185+29	17.161	32.0	
X	SB	205+12	17.578	32.0	
X	NB	218+11	17.824	32.0	
X	SB	238+65	18.213	32.0	
X	NB	241+07	18.259	32.0	
X	NB	245+05	18.333	32.0	
X	NB	249+39	18.416	32.0	
X	NB	264+78	18.708		21.3
X	NB	284+89	19.088	32.0	
X	NB	288+14	19.165	32.0	
X	NB	292+66	19.250		61.1
X	SB	302+95	19.445	32.0	
X	NB	303+08	19.447	32.0	
X	NB	312+16	19.620		21.3
X	NB	322+10	19.808	32.0	

<b>SCHEDULE AND SUMMARY OF MAJOR AND MINOR PAVEMENT REPAIRS</b>					
<b>I-65 - WARREN COUNTY - ITEM NO. 03-20016.00</b>					
<b>APPROXIMATE LOCATION</b>				<b>MAJOR BLOW UP PAVEMENT REPAIR BID ITEM 03240 (sq. yd.)</b>	<b>MINOR (BLOW UP) PAVEMENT REPAIR DETAIL BID ITEM 20757ED (sq. yd.)</b>
<b>I-65</b>	<b>DIRECTION</b>	<b>STATION</b>	<b>MILEPOINT</b>		
X	NB	327+18	19.904	32.0	
X	SB	331+80	19.991	32.0	
X	NB	334+05	20.034	32.0	
X	SB	335+10	20.054	32.0	
X	NB	339+97	20.146		21.3
X	NB	343+93	20.221	32.0	
X	NB	351+30	20.361	32.0	
X	NB	358+80	20.503	32.0	
X	NB	368+24	20.682		21.3
X	NB	368+82	20.692	32.0	
X	SB	371+74	20.748	32.0	
X	NB	372+09	20.754	32.0	
X	SB	374+06	20.792	32.0	
X	NB	374+09	20.792	32.0	
X	NB	378+36	20.873		21.3
X	NB	382+56	20.953	32.0	
X	SB	390+04	21.075	32.0	
X	NB	391+92	21.130	32.0	
X	SB	396+19	21.211	32.0	
X	NB	399+33	21.270	32.0	
X	NB	403+88	21.356	32.0	
X	NB	411+63	21.503		21.3
X	NB	422+41	21.707	32.0	
X	NB	431+74	21.884		21.3
X	NB	433+32	21.914	32.0	
X	NB	439+37	22.029	32.0	
X	SB	439+77	22.036	32.0	
X	SB	442+97	22.097	32.0	
X	NB	447+38	22.180	32.0	
X	SB	497+53	23.130	32.0	

<b>SCHEDULE AND SUMMARY OF MAJOR AND MINOR PAVEMENT REPAIRS</b>					
<b>I-65 - WARREN COUNTY - ITEM NO. 03-20016.00</b>					
<b>APPROXIMATE LOCATION</b>				<b>MAJOR BLOW UP PAVEMENT REPAIR BID ITEM 03240 (sq. yd.)</b>	<b>MINOR (BLOW UP) PAVEMENT REPAIR DETAIL BID ITEM 20757ED (sq. yd.)</b>
<b>I-65</b>	<b>DIRECTION</b>	<b>STATION</b>	<b>MILEPOINT</b>		
X	NB, SB	See Note 3	See Note 3		745.5
<b>TOTALS:</b>				<b>1440</b>	<b>1105</b>

NOTES:

1. Locations and quantities of repairs are approximate. Actual locations and quantity will be determined by the Engineer.
2. Repair quantities are carried over and included in the General Summary.
3. A quantity of 745.5 square yards has been included for 35 miscellaneous locations for Minor Pavement Repairs. Locations to be determined by the Engineer.

<b>SCHEDULE AND SUMMARY OF DRAINAGE REPAIRS</b>							
<b>I-65 - WARREN COUNTY - ITEM NO. 03-20016.00</b>							
<b>APPROXIMATE LOCATION</b>					<b>ITEM</b>		
<b>I-65</b>	<b>DIRECTION</b>	<b>STATIONS</b>	<b>MILEPOINTS</b>	<b>NOTES</b>	<b>SQ. YD.</b>	<b>TON</b>	<b>EACH</b>
					<b>REMOVE PAVED DITCH</b>	<b>CHANNEL LINING CLASS II</b>	<b>REPLACE GRATE</b>
					<b>02165</b>	<b>02483</b>	<b>20366NN</b>
X	SB	35+95	14.392	4			1
X	SB	40+39	14.476	4			1
X	NB	75+02	15.114	2	44	8	
X	SB	108+76	15.753	4			1
X	NB	114+60	15.863	2	42	8	
X	SB	121+80	16.000	4			1
X	NB	129+52	16.145	4			1
X	NB	133+80	16.227	3		2	
X	NB	142+67	16.395	3		2	
X	NB	146+27	16.463	3		2	
X	NB	150+70	16.547	3		2	
X	NB	158+70	16.698	3		2	
X	SB	167+08	16.857	4			1
X	NB	172+29	16.956	4			1
X	SB	197+02	17.424	4			1
X	NB	219+31	17.846	4			1
X	SB	234+45	18.133	4			1
X	SB	249+67	18.421	4			1
X	SB	253+88	18.501	4			1
X	SB	258+54	18.590	4			1
X	SB	292+25	19.242	4			1
X	NB	316+49	19.701	4			1
X	SB	316+52	19.702	4			1
X	SB	320+00	19.768	4			1
X	SB	346+02	20.261	4			1
X	SB	408+10	21.437	4			1

<b>SCHEDULE AND SUMMARY OF DRAINAGE REPAIRS</b>							
<b>I-65 - WARREN COUNTY - ITEM NO. 03-20016.00</b>							
<b>APPROXIMATE LOCATION</b>					<b>ITEM</b>		
<b>I-65</b>	<b>DIRECTION</b>	<b>STATIONS</b>	<b>MILEPOINTS</b>	<b>NOTES</b>	<b>SQ. YD.</b>	<b>TON</b>	<b>EACH</b>
					<b>REMOVE PAVED DITCH</b>	<b>CHANNEL LINING CLASS II</b>	<b>REPLACE GRATE</b>
					<b>02165</b>	<b>02483</b>	<b>20366NN</b>
X	NB	430+95 TO 435+28	21.869 TO 21.951	2	338	61	
X	NB	488+92	22.967	4			1
X	NB	496+45	23.110	4			1
X	SB	505+45	23.279	4			2
X	NB	505+48	23.281	4			1
X	SB	510+50	23.376	4			1
X	SB	519+16 TO 521+32	23.539 TO 23.579	2	177	32	
X	NB	519+42 TO 520+61	23.545 TO 23.568	2	93	17	
X	NB	530+12	23.748	4			1
X	SB	530+23	23.748	4			1
X	SB	549+42 TO 552+82	24.111 TO 24.178	2	275	50	
X	NB	551+16 TO 554+37	24.146 TO 24.206	2	252	45	
X	NB	554+73 TO 560+34	24.214 TO 24.320	2	439	79	
X	SB	567+74 TO 570+14	24.461 TO 24.507	2	189	34	
X	NB	568+54 TO 570+78	24.475 TO 24.518	2	180	32	
X	NB	584+39 TO 584+76	24.775 TO 24.782	2	49	9	
X	SB	592+91	24.937	4			1
X	SB	598+17 TO 599+34	25.074 TO 25.058	2	93	17	
<b>PROJECT TOTALS:</b>					<b>2,172</b>	<b>401</b>	<b>28</b>

**NOTES:**

1. Quantities are carried over and included in General Summary.
2. Channel Lining Class II is included for placement on top of broken paved ditches. Assumed depth of placement is 6 inches. Breaking the existing paved ditch is included in "Remove Paved Ditch." Concrete shall be broken to size of channel lining Class II.
3. Channel Lining Class II is included for repairing erosion around existing headwalls.
4. Size of grate at each location to be field verified by Contractor and approved by Engineer.

SCHEDULE AND SUMMARY OF EROSION REPAIRS											
I-65 - WARREN COUNTY - ITEM NO. 03-20016.00											
APPROXIMATE LOCATION											
I-65	DIRECTION	STATIONS	MILEPOINTS	SHOULDER AND FILL SLOPE REPAIR		CUT SLOPE EROSION REPAIR		MEDIAN EROSION REPAIR		NOTES	
				CRUSHED AGGREGATE SIZE NO 2	CHANNEL LINING CLASS II	SQ. YD.	CRUSHED AGGREGATE SIZE NO 2	CRUSHED AGGREGATE SIZE NO 2	TON		
X	SB	39+34 TO 45+35	14.456 TO 14.570	00078	02483	----	00078	00078	00078	3	
X	NB	86+96 TO 92+52	15.340 TO 15.445			805	185	114		3	
X	NB	107+79 TO 112+00	15.734 TO 15.814			494	140			3	
X	SB	352+24 TO 353+19	20.378 TO 20.397			607				2	
X	NB	355+09 TO 355+54	20.433 TO 20.441							2	
X	NB	428+12 TO 430+45	21.816 TO 21.860			285	65			3	
X	SB	441+43 TO 447+65	22.068 TO 22.185	175	2					2,3	
X	NB	571+18 TO 580+28	24.525 TO 24.697			1625	374			3	
X	SB	571+72 TO 574+34	24.537 TO 24.586			464	107			3	
X	NB	572+13 TO 573+85	24.543 TO 24.576			325	75			3	
<b>PROJECT TOTALS:</b>				<b>175</b>	<b>2</b>	<b>4,605</b>	<b>1,059</b>	<b>30</b>	<b>94</b>		

- NOTES:
- Quantities are carried over and included in General Summary.
  - Channel Lining Class II is included for filling in deeply eroded areas.
  - Crushed Stone Aggregate No. 2 estimated at 2.07 tons per cubic yard.

**GENERAL NOTES**  
**I-65 – WARREN COUNTY**  
**PAGE 1 OF 4**

**I. GENERAL**

Perform all work in accordance with the Kentucky Transportation Cabinet, Department of Highways, Standard Specifications for Road and Bridge Construction, Current Edition, Supplemental Specifications, any applicable Special Provisions, and applicable Standard and Sepia Drawings, except as hereafter specified. Article references are to the Standard Specifications. Furnish all materials, labor, equipment, and incidentals for the work identified in the proposal.

**II. MATERIALS**

Except as specified in these notes or on the drawings, all materials will be according to the Standard Specifications and applicable Special Provisions and Special Notes. The Department will sample and test all materials according to Department's Sampling Manual and the Contractor will have the materials available for sampling a sufficient time in advance of the use of the materials to allow for the necessary time for testing, unless otherwise specified in these notes.

**III. CONSTRUCTION METHODS**

**A. Maintain and Control Traffic**

See Traffic Control Plan and Standard Specifications.

**B. Site Preparation**

Be responsible for all site preparation. Do not disturb existing signs unless noted on the plans. This item will include, but is not limited to, incidental excavation and backfilling; removal of all obstructions or any other items; disposal of materials; sweeping and removal of debris; shoulder preparation and restoration, temporary and permanent erosion and pollution control; and all incidentals. Site preparation will be only as approved or directed by the Engineer. Other than the bid items listed, no direct payment will be made for site preparation, but will be incidental to the other items of work.

**B. Disposal of Waste**

Dispose of all cuttings, debris, and other waste off the right-of-way at approved sites obtained by the Contractor at no additional cost to the Department. The Contractor will be responsible for obtaining any necessary permits for this work. Temporary openings in the right of way fence for direct access to waste sites off the right of way or for access to other public roads will not be allowed. No separate payment will be made for the disposal of waste and debris from the project or obtaining the necessary permits but will be incidental to the other items of the work.

**C. Final Dressing, Clean Up, and Seeding and Protection**

After all work is completed, completely remove all debris from the job site. Perform Class A Final Dressing on all disturbed areas. Sow disturbed earthen areas with Seed Mixture No. 1. These items are incidental to other items in the contract.

**D. Guardrail**

Remove and replace guardrail and guardrail end treatments listed in this proposal and/or as directed by the Engineer. Guardrail, end treatments and terminal sections are listed by mile points and quantities are approximate only. Actual locations will be determined by the Engineer at the time of construction. Grade and reshape shoulders to proper template for new guardrail and end treatment. Utilize DGA for embankment when required for new end treatments. Remove any existing guardrail with a lane closure in place. Do not leave the area unprotected. After the guardrail is removed, a shoulder closure shall remain in place until the guardrail is replaced in that area. To minimize safety hazards, guardrail removal is to be performed at the latest practical time prior to initiating the paving operation in an area and re-installation is to begin within 5 calendar days from the time that the final base course is completed and shall be pursued until completion. If guardrail installation is not started within 5 calendar days after paving operations ends, liquated damages will be charged as outlined in Section 108 in the current edition of the Standard Specifications.

**GENERAL NOTES**  
**I-65 – WARREN COUNTY**  
**PAGE 2 OF 4**

The Contractor shall deliver existing salvaged guardrail system materials to the Central Sign Shop and Recycle Center in Frankfort, KY (502-564-8187) between the hours of 8:00 AM and 3:00 PM, Monday through Friday, and shall be neatly stacked in accordance with section 719.03.07 of the standard specifications. There is a guardrail delivery verification sheet which must be completed. The Contractor, Engineer, and Central Sign/Guardrail Center representative must all sign off on this sheet before payment may be made.

**E. Pavement Striping and Pavement Markers**

Permanent striping will be in accordance with Section 714, except that:

- (1) Permanent striping will be in place before a lane is opened to traffic; and
- (2) Permanent striping will be Extruded Thermoplastic Marking.

**F. On-Site Inspection**

Each Contractor submitting a bid for this work will make a thorough inspection of the site prior to submitting a bid and will thoroughly familiarize himself with existing conditions so that the work can be expeditiously performed after a contract is awarded. Submission of a bid will be considered evidence of this inspection having been made. Any claims resulting from site conditions will not be honored by the Department.

**G. Caution**

Information shown on the drawings and in this proposal and the types and quantities of work listed are not to be taken as an accurate or complete evaluation of the material and conditions to be encountered during construction. The bidder must draw his own conclusions as to the conditions encountered. The Department does not give any guarantee as to the accuracy of the data and no claim will be considered for additional compensation if the conditions encountered are not in accordance with the information above.

**H. Utility Clearance**

It is not anticipated that any utility facilities will need to be relocated and/or adjusted; however, if it is discovered that the work does require that utilities be relocated and/or adjusted, the utility companies will work concurrently with the Contractor while relocating their facilities.

**IV. METHOD OF MEASUREMENT**

**A. Maintain and Control Traffic**

See Traffic Control Plan.

**B. Site Preparation**

Other than the bid items listed, site preparation will not be measured for payment, but will be incidental to the other items of work.

**C. Dense Graded Aggregate**

DGA used for guardrail and guardrail end treatments will be measured for payment.

**D. Pavement Repairs**

Pavement repairs will be measured per square yard.

**E. Inlaid Pavement Markers and Permanent Striping**

Permanent striping is measured per linear foot. Inlaid Pavement Markers are measured as each.

**V. BASIS OF PAYMENT**

No direct payment will be made other than for the bid items listed. All other items required to complete the construction will be incidental to the bid items listed. Existing signs (not to be disturbed) that are damaged by the Contractor will be replaced by the Contractor at his expense.

**GENERAL NOTES**  
**I-65 – WARREN COUNTY**  
**PAGE 3 OF 4**

**A. Maintain and Control Traffic**

See Traffic Control Plan.

**B. Site Preparation**

Other than the bid items listed, no direct payment will be allowed for site preparation, but will be incidental to the other items of work.

**C. Dense Grade Aggregate**

See Section 302 of the Standard Specifications.

**D. Inlaid Pavement Markers and Permanent Striping**

See Special Notes and Traffic Control Plan.

**E. Pavement Repairs**

Pavement repairs will be paid for by square yard. The bid items "Pavement Repair" for minor repairs and "Base Failure Repair" for major repairs include all materials and work need to complete each repair as directed by the Engineer.

**F. Ditching and Shouldering**

In accordance with Section 209 of the Standard Specifications, the bid item "Ditching and Shouldering" includes ditching on both sides of the roadway and the median for the entire length of the project where there is milling and pavement. Cleaning of all drainage structures, including drop box inlets, perforated pipe headwalls, and pipe structures 36 inches in diameter or less is also included in this bid item. It shall also include removal of any vegetation growing along the base of the median barrier wall.

**G. Lane Closures**

Contrary to Section 112, lane closures will not be measured for payment but will be incidental to the bid item "Maintain and Control Traffic". Arrow boards, portable message boards, and signs shall be paid for one time regardless of how many times they are moved.

**VI. MISCELLANEOUS**

- A. The dimensions shown on the typical sections for pavement and shoulder widths and thickness are nominal or typical dimensions. The actual dimensions to be constructed may be varied to fit existing conditions as directed or approved by the Engineer. It is not intended that existing pavement or shoulders be widened unless specified in the Proposal.
- B. The Contractor is advised that locations of low wires crossing the roadway exist. These and all other utilities should be avoided on this project. If any utility is impacted, it will be the Contractor's responsibility to contact the affected utility and cover any costs associated with the impact.
- C. Guardrail, End Treatments, and Terminal Sections to be replaced are listed by mileposts. Exact placement to be approved by the Engineer on construction.
- D. Any signs (not to be replaced) and any light poles that are damaged during Construction are to be replaced at the Contractor's expense.
- E. The existing edge drain system is to be preserved. Care should be taken when the asphalt is removed and replaced, any edge drains damaged during these activities will be replaced at the Contractor's expense.
- F. Pavement rideability requirements in accordance with Section 410 Category A of the standard specifications shall apply on this project.
- G. The Department will accept the compaction of asphalt mixtures furnished for the driving lanes at one inch or greater on this project by Option A according to subsections 402 and 403 of the Standard Specifications. The Department will accept the compaction of all other mixtures by Option B.

**GENERAL NOTES**  
**I-65 – WARREN COUNTY**  
**PAGE 4 OF 4**

- H. The Contractor shall be responsible for the repair of any asphalt in the travelled lanes that becomes detrimental or hazardous to the travelling public during construction. Areas needing repair will be at the discretion of the Engineer.
- I. No tree cutting is allowed nor should it be necessary.
- J. The Contractor shall deliver up to 1,000 tons of milled asphalt material to the District 3 Warren County Section Engineer's Office between the hours of 7:00 AM and 3:00 PM, Monday through Friday. The material shall be dumped in areas of the storage area as directed by the Engineer.
- K. Delineators shall meet the requirements of Section 830 and 838 of the Standard Specifications. Delineators shall be placed in accordance with Section 3F of the M.U.T.C.D., current edition and Kentucky Standard Drawings, current edition. In areas where there is milling and asphalt, the delineators for the existing guardrail that is left in place shall be replaced. Delineators on median barrier wall shall be replaced as directed by the Engineer. It is assumed that 25% of them may need to be replaced.
- L. Quantities have been included in the General Summary for pavement repairs, which are carried over from the Schedule and Summary of Major and Minor Pavement Repairs. The Engineer will determine the actual locations that will be repaired based upon the condition of the pavement at the time the repairs are accomplished. The Engineer shall determine the extent of the repairs.
- M. Trackless tack material shall be used.
- N. Allowing traffic to travel on milled surface is not allowed unless approved by the Engineer.
- O. A vacuum truck shall be required during all milling operations.
- P. Headwall erosion repair shall consist of regrading of the inlet or outlet shown on the plans and placement of 24-inch thick Class II Channel Lining as directed by the Engineer. The regrading work is incidental to the Class II Channel Lining.
- Q. The mile marker signs on the median barrier wall are to be replaced. As approved by the Engineer, the existing signing hardware may be reused.
- R. Drainage grates that are missing are to be replaced. Contractor shall field verify various sizes of grates that are required and these shall be approved by the Engineer.
- S. Contractor shall insure that fog seal is not sprayed on barrier wall or guardrail.
- T. The Contractor shall verify the existing pavement cross slopes in all in curve transitions (runoff and runoff) areas prior to paving operations and submit it to the Engineer. After paving operations, the Contractor shall survey the cross slopes again at the same locations to verify that the cross slopes are still draining properly and are acceptable. The Contractor shall take cross slopes across the entire pavement width – lanes and shoulders. The cross slopes shall be verified every 50 foot. This work is part of bid item "Staking".
- U. Law enforcement officers will be required to be furnished on the project at any time that traffic is reduced to one lane. The contractor will be required to establish an agreement with a local law enforcement agency to provide an officer and police cruiser to be used to warn traffic of lane closures and stopped traffic ahead. The contractor will be responsible to reimburse the agency of the costs for this service. This requirement is solely for the intent of warning traffic of a potential danger ahead and not for the purpose of issuance of traffic violations. The officer should however have authority to issue citations if necessary and at his discretion. Patrolling for speeding and issuance of double fine citations should be performed by a separate officer and the contractor will not be required to reimburse the agency for that operations. **No direct payment will be made** for the providing of law enforcement officers and will be considered **incidental** to "Maintain and Control Traffic".

COUNTY OF	ITEM NO.
WARREN	3-20016.00

# EXISTING TYPICAL SECTIONS

MP 13.711 TO MP 13.9  
MP 14.3 TO MP 21.0  
MP 22.1 TO MP 23.6  
MP 24.8 TO MP 25.2

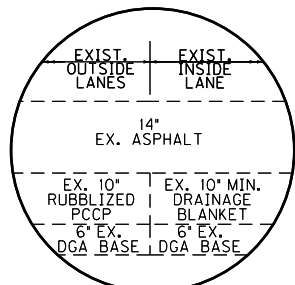
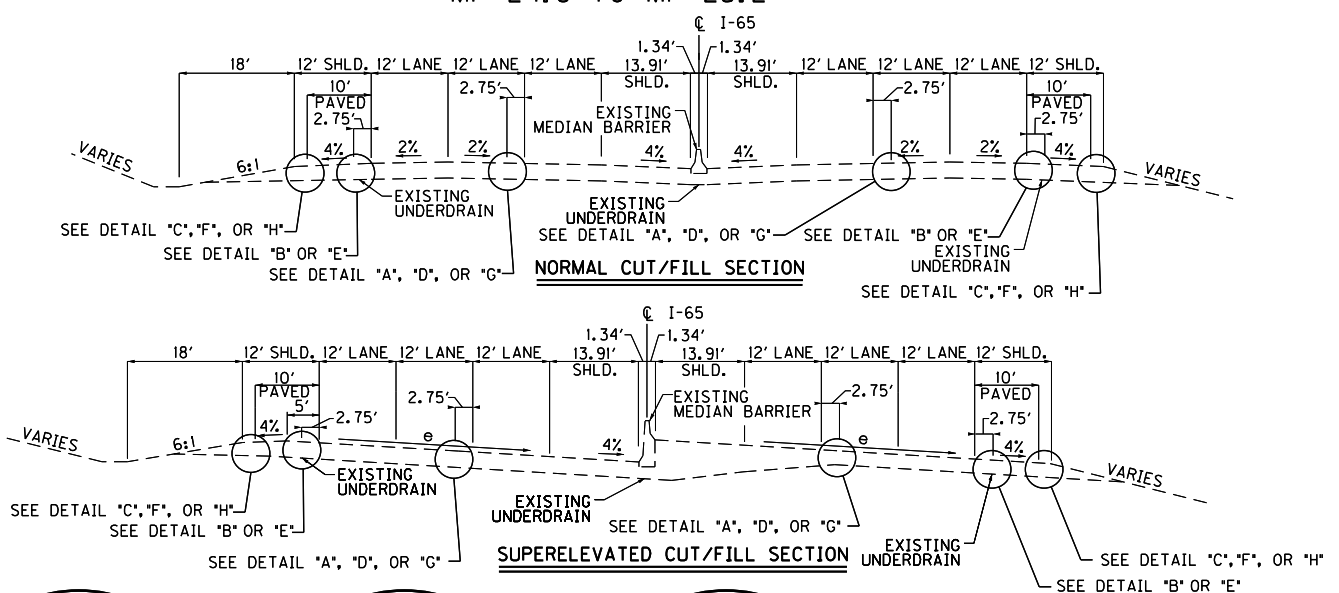

**DETAIL "A"**  
NOT TO SCALE

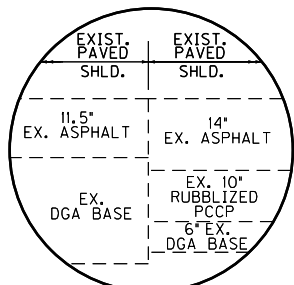

**DETAIL "B"**  
NOT TO SCALE

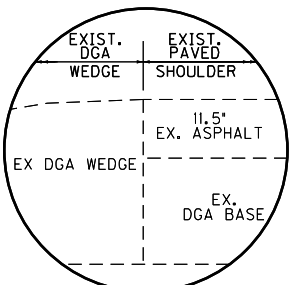

**DETAIL "C"**  
NOT TO SCALE

MP 13.711 TO MP 13.9 & MP 14.3 TO MP 19.1

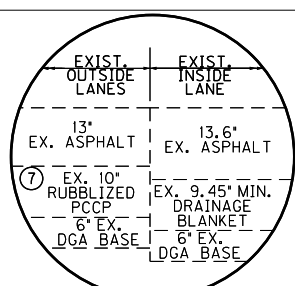

**DETAIL "D"**  
NOT TO SCALE

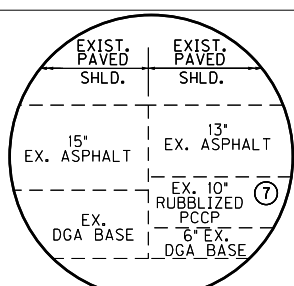

**DETAIL "E"**  
NOT TO SCALE

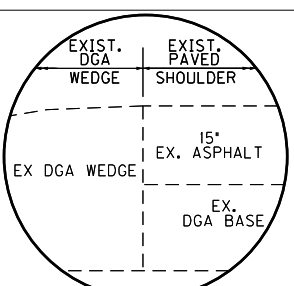

**DETAIL "F"**  
NOT TO SCALE

MP 22.1 TO MP 23.6 & MP 24.8 TO MP 25.2

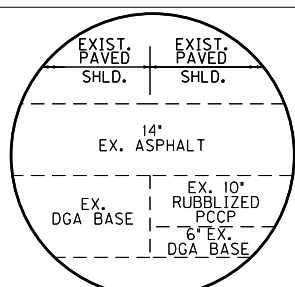

**DETAIL "G"**  
NOT TO SCALE

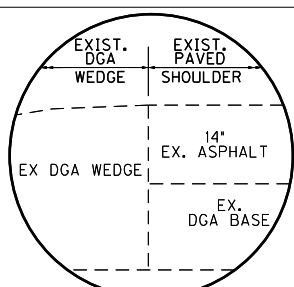

**DETAIL "H"**  
NOT TO SCALE

MP 19.1 TO MP 21.0

**NOTES**

- 1 TRAVEL LANES AND OUTSIDE SHOULDERS VARY FROM 11.81' TO 12'.
- 2 PAVED OUTSIDE SHOULDERS VARY FROM 9.84' TO 10'.
- 3 PAVED SHOULDER EXTENDS TO FACE OF GUARDRAIL.
- 4 INSIDE SHOULDERS VARY 13.85' TO 13.91'.
- 5 DITCH OFFSET VARIES 18.0' TO 17.72'.
- 6 CROSS SLOPES BASED ON RECORD PLANS.
- ⑦ EXISTING PCCP IS BROKEN AND SEATED AT MP 22.1 TO MP 23.6 AND MP 24.8 TO MP 24.954.

NOT TO SCALE

EXISTING TYPICAL SECTIONS  
SHEET 1 OF 6

COUNTY OF	ITEM NO.
WARREN	3-20016.00

# EXISTING TYPICAL SECTIONS

MP 13.9 TO MP 14.3

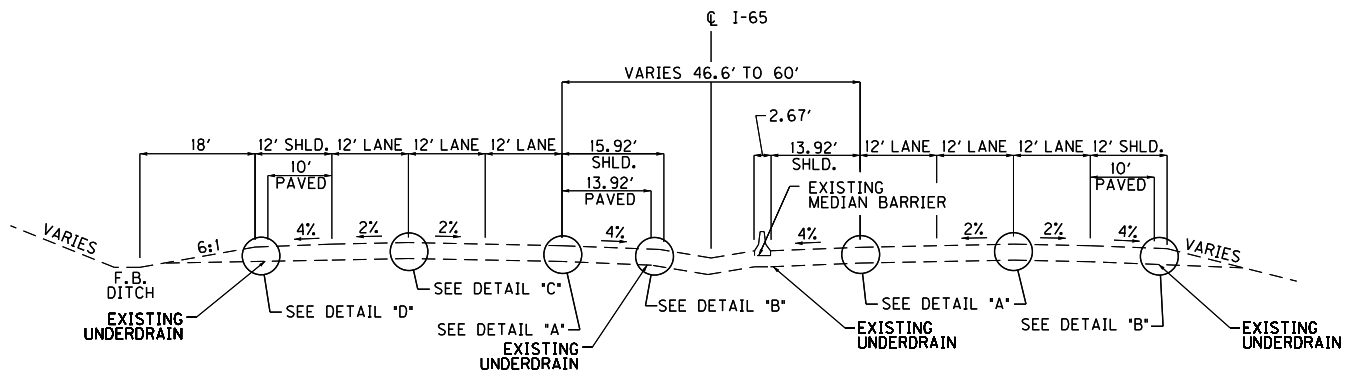

NORMAL BARRIER TRANSITION CUT/FILL SECTION

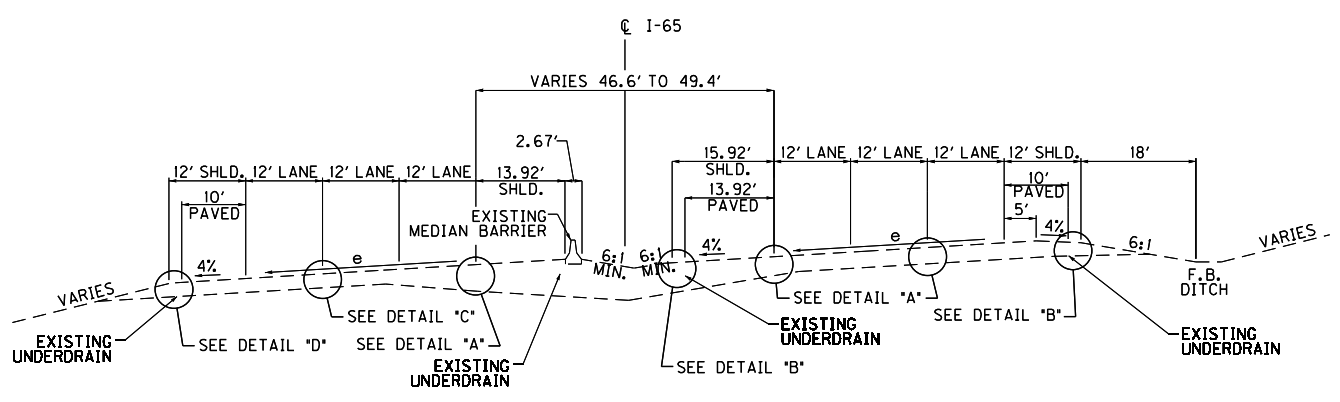

SUPERELEVATED BARRIER TRANSITION FILL/CUT SECTION

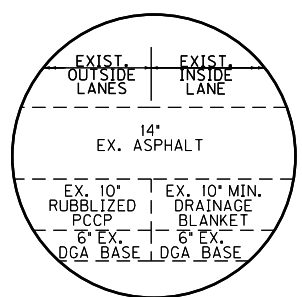

**DETAIL "A"**  
NOT TO SCALE

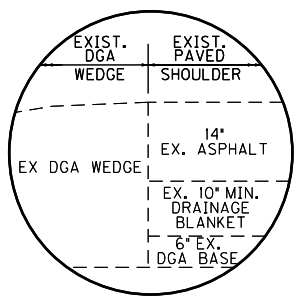

**DETAIL "B"**  
NOT TO SCALE

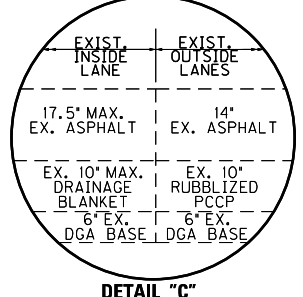

**DETAIL "C"**  
NOT TO SCALE

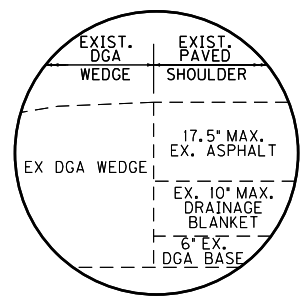

**DETAIL "D"**  
NOT TO SCALE

**NOTES**

- 1 PAVED SHOULDER EXTENDS TO FACE OF GUARDRAIL.
- 2 CROSS SLOPES BASED ON RECORD PLANS.

NOT TO SCALE

EXISTING TYPICAL SECTIONS  
SHEET 2 OF 6

COUNTY OF	ITEM NO.
WARREN	3-20016.00

# EXISTING TYPICAL SECTIONS

MP 21.0 TO MP 22.1

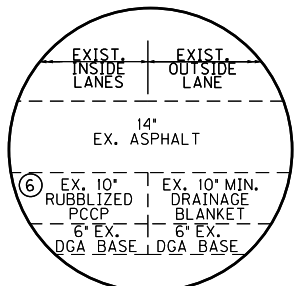
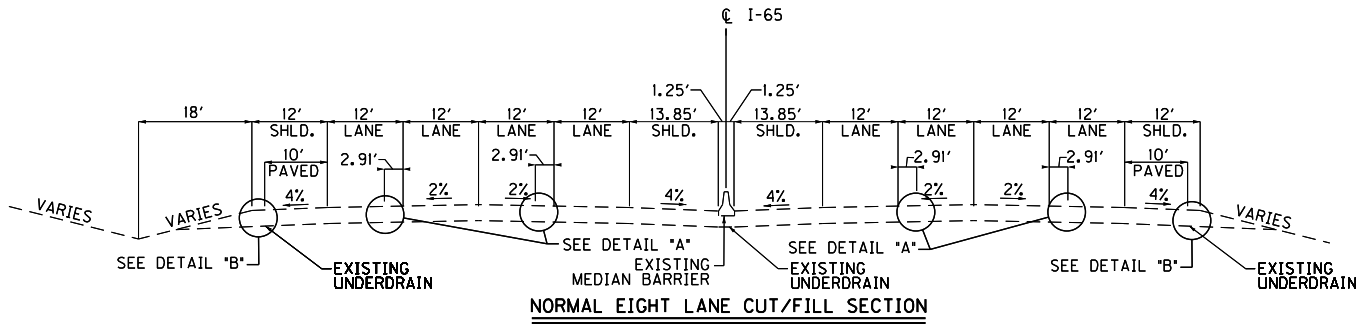

**DETAIL "A"**  
NOT TO SCALE

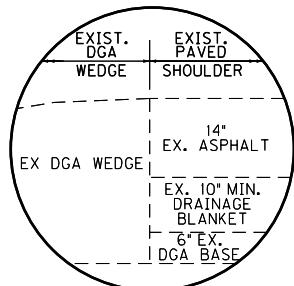

**DETAIL "B"**  
NOT TO SCALE

**NOTES**

- 1 TRAVEL LANES AND OUTSIDE SHOULDERS VARY FROM 11.81' TO 12'.
- 2 PAVED OUTSIDE SHOULDERS VARY FROM 9.84' TO 10'.
- 3 PAVED OUTSIDE SHOULDER EXTENDS TO FACE OF GUARDRAIL.
- 4 DITCH OFFSET VARIES 18.0' TO 17.72'.
- 5 CROSS SLOPES BASED ON RECORD PLANS.
- ⑥ EXISTING PCCP IS BROKEN AND SEATED AT MP 21.950 TO MP 22.1.

NOT TO SCALE

COUNTY OF	ITEM NO.
WARREN	3-20016.00

# EXISTING TYPICAL SECTIONS

MP 23.6 TO MP 24.8

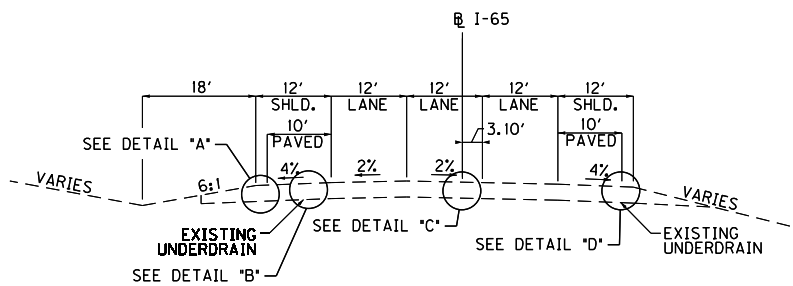

**NORMAL SOUTHBOUND BIFURCATED CUT/FILL SECTION**

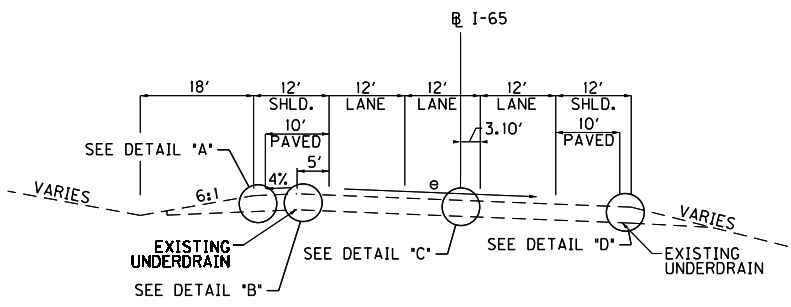

**LEFT SUPERELEVATED SOUTHBOUND BIFURCATED CUT/FILL SECTION**

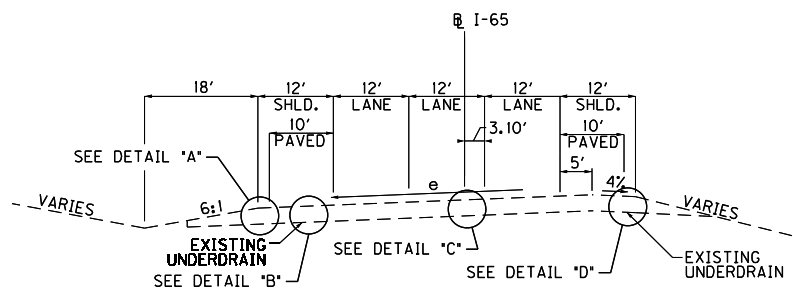

**RIGHT SUPERELEVATED SOUTHBOUND BIFURCATED CUT/FILL SECTION**

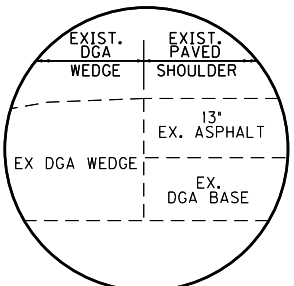

**DETAIL "A"**  
NOT TO SCALE

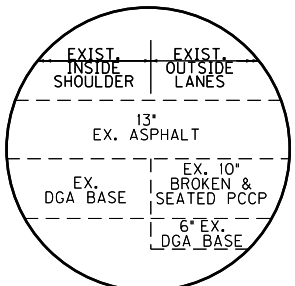

**DETAIL "B"**  
NOT TO SCALE

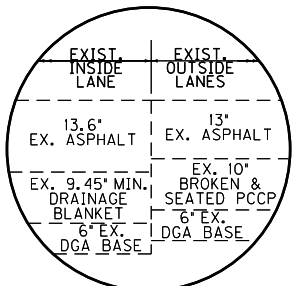

**DETAIL "C"**  
NOT TO SCALE

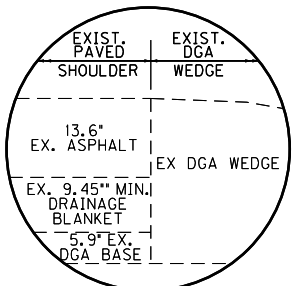

**DETAIL "D"**  
NOT TO SCALE

**NOTES**

- 1 TRAVEL LANES AND SHOULDERS VARY FROM 11.81' TO 12'.
- 2 PAVED SHOULDERS VARY FROM 9.84' TO 10'.
- 3 PAVED SHOULDER EXTENDS TO FACE OF GUARDRAIL.
- 4 DITCH OFFSET VARIES 18.0' TO 17.72'.
- 5 CROSS SLOPES BASED ON RECORD PLANS.

NOT TO SCALE

COUNTY OF	ITEM NO.
WARREN	3-20016.00

# EXISTING TYPICAL SECTIONS

MP 23.6 TO MP 24.8

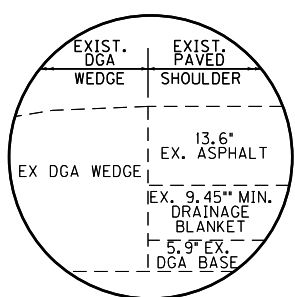
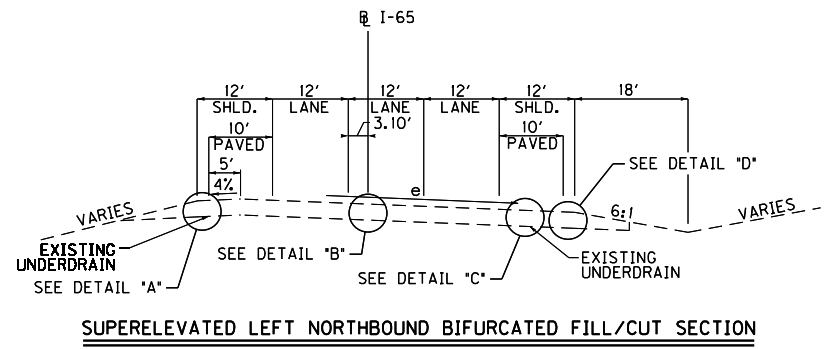
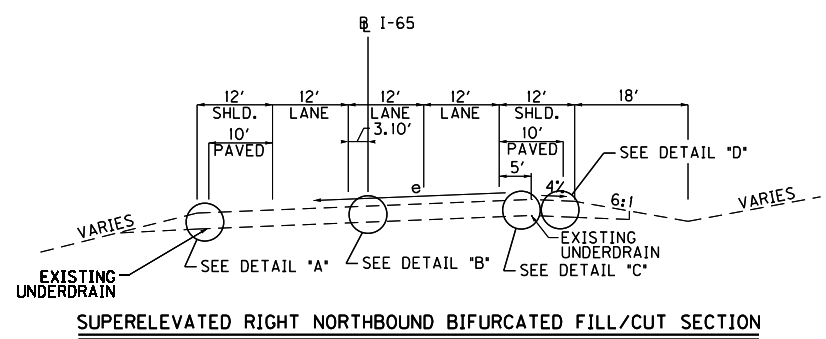
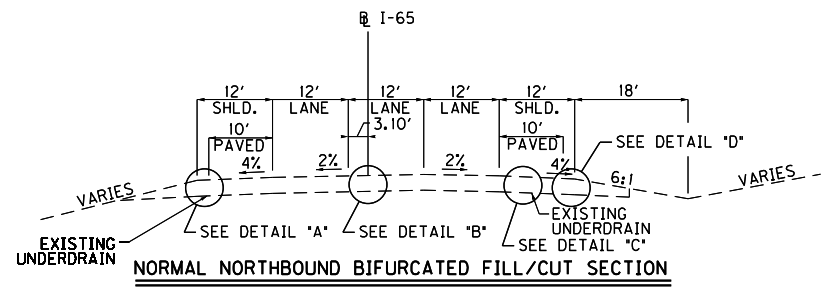

**DETAIL "A"**  
NOT TO SCALE

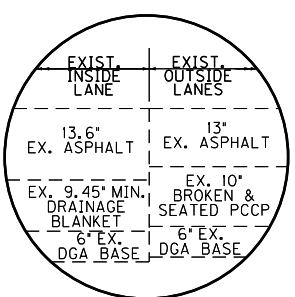

**DETAIL "B"**  
NOT TO SCALE

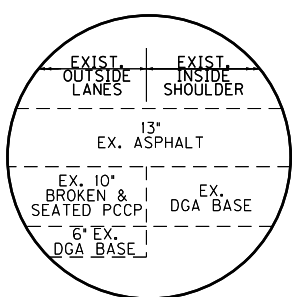

**DETAIL "C"**  
NOT TO SCALE

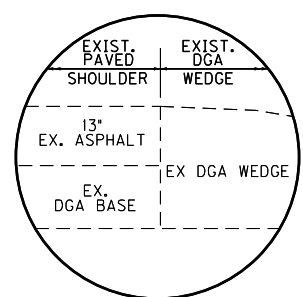

**DETAIL "D"**  
NOT TO SCALE

**NOTES**

- 1 TRAVEL LANES AND SHOULDERS VARY FROM 11.81' TO 12'.
- 2 PAVED SHOULDERS VARY FROM 9.84' TO 10'.
- 3 PAVED SHOULDER EXTENDS TO FACE OF GUARDRAIL.
- 4 DITCH OFFSET VARIES 18.0' TO 17.72'.
- 5 CROSS SLOPES BASED ON RECORD PLANS.

NOT TO SCALE

EXISTING TYPICAL SECTIONS  
SHEET 5 OF 6

COUNTY OF	ITEM NO.
WARREN	3-20016.00

# EXISTING TYPICAL SECTIONS

I-65 AND US 231 INTERCHANGE

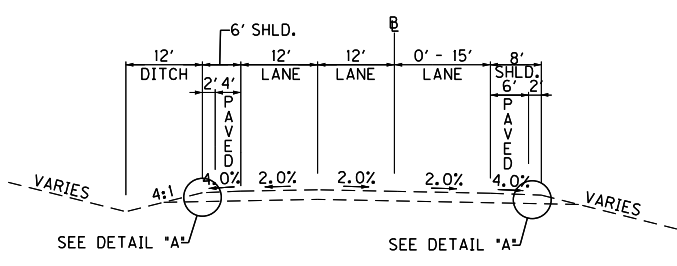

NORMAL CUT/FILL SECTION

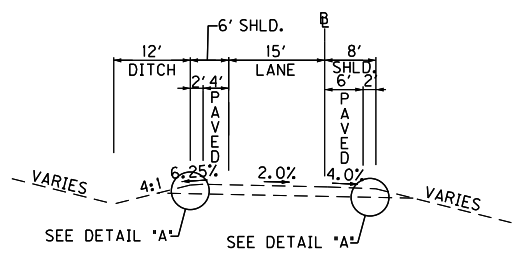

NORMAL CUT/FILL SECTION

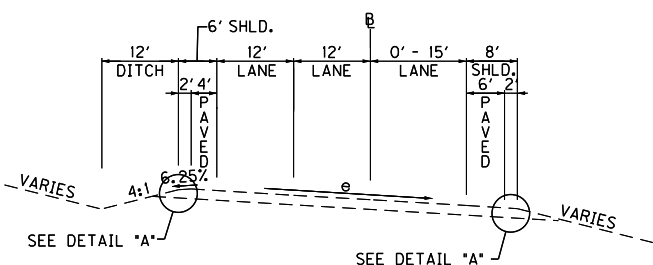

SUPERELEVATED RIGHT CUT/FILL SECTION

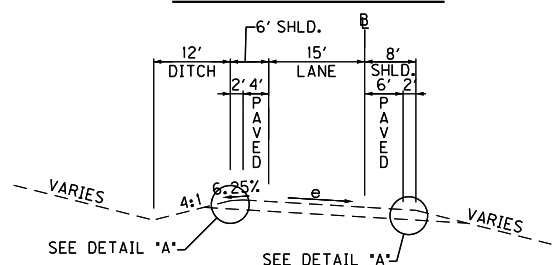

SUPERELEVATED RIGHT CUT/FILL SECTION

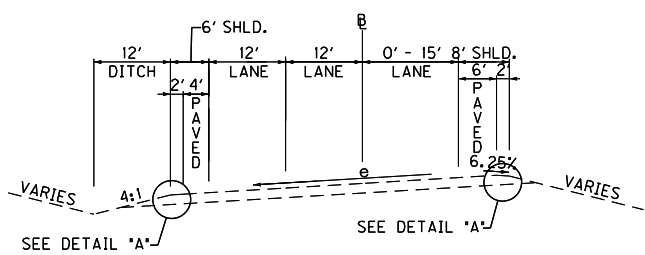

SUPERELEVATED LEFT CUT/FILL SECTION

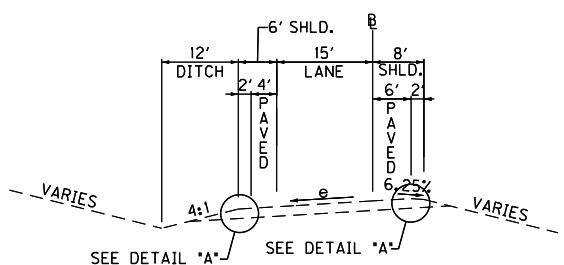

SUPERELEVATED LEFT CUT/FILL SECTION

**TWO LANE RAMP  
RAMPS A, B, C, & D**

**ONE LANE RAMP  
RAMPS A1, B1, C1, & D1**

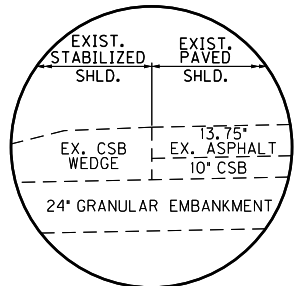

**DETAIL "A"**  
NOT TO SCALE

**NOTES**

- 1 PAVED SHOULDER EXTENDS TO FACE OF GUARDRAIL.
- 2 CROSS SLOPES BASED ON RECORD PLANS.

NOT TO SCALE

EXISTING TYPICAL SECTIONS  
SHEET 6 OF 6

COUNTY OF	WARREN
ITEM NO.	3-20016.00

# PROPOSED TYPICAL SECTIONS

MP 13.711 TO MP 13.9  
MP 14.3 TO MP 21.0  
MP 22.1 TO MP 23.6  
MP 24.8 TO MP 25.2

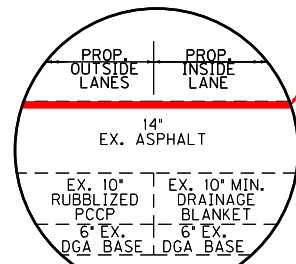
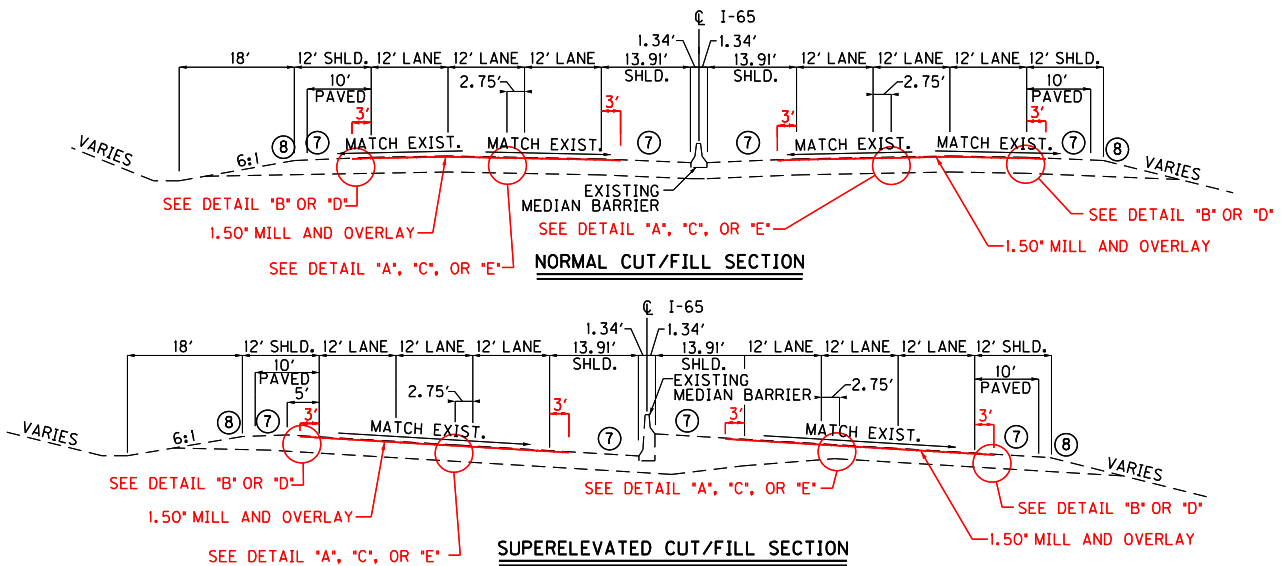

**DETAIL "A"**  
NOT TO SCALE

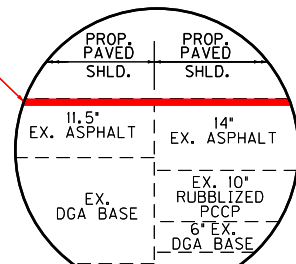

**DETAIL "B"**  
NOT TO SCALE

MP 13.711 TO MP 13.9 & MP 14.3 TO MP 19.1

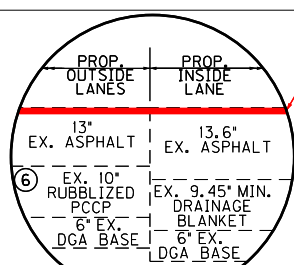

**DETAIL "C"**  
NOT TO SCALE

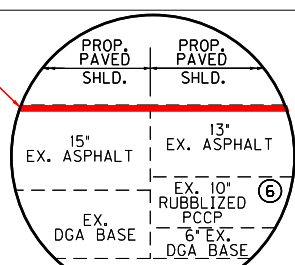

**DETAIL "D"**  
NOT TO SCALE

MP 22.1 TO MP 23.6 & MP 24.8 TO MP 25.2

**NOTES**

- 1 TRAVEL LANES AND OUTSIDE SHOULDERS VARY FROM 11.81' TO 12'.
- 2 PAVED OUTSIDE SHOULDERS VARY FROM 9.84' TO 10'.
- 3 INSIDE SHOULDERS VARY 13.85' TO 13.91'.
- 4 DITCH OFFSET VARIES 18.0' TO 17.72'.
- 5 CROSS SLOPES BASED ON RECORD PLANS.
- 6 EXISTING PCCP IS BROKEN AND SEATED AT MP 22.1 TO MP 23.6 AND MP 24.8 TO MP 24.954.
- 7 FROM EDGE OF MILL AND OVERLAY TO EDGE OF PAVED SHOULDER, APPLY ASPHALT EMULSION FOR FOG SEAL . SEE SPECIAL NOTE FOR FOG SEAL.
- 8 IN AREAS WITHOUT EXISTING GUARDRAIL, ASPHALT SEAL REQUIRED FROM OUTSIDE EDGE OF PAVED SHOULDER TO A POINT 2 FEET DOWN THE DITCH OR FILL SLOPE. TWO APPLICATIONS OF THE FOLLOWING:  
 ASPHALT SEAL COAT @ 2.40 LBS. /SQ. YD.  
 ASPHALT SEAL AGGREGATE @ 20 LBS. /SQ. YD.

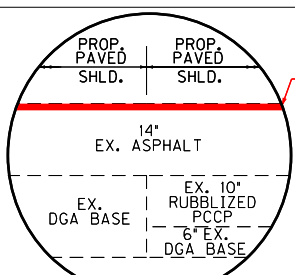

**DETAIL "E"**  
NOT TO SCALE

MP 19.1 TO MP 21.0

NOT TO SCALE

PROPOSED TYPICAL SECTIONS  
SHEET 1 OF 6

COUNTY OF	ITEM NO.
WARREN	3-20016.00

# PROPOSED TYPICAL SECTIONS

MP 13.9 TO MP 14.3

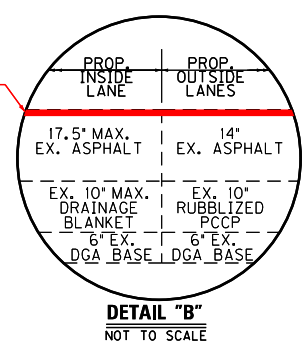
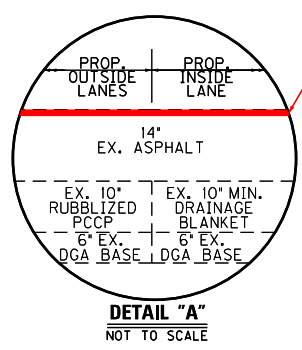
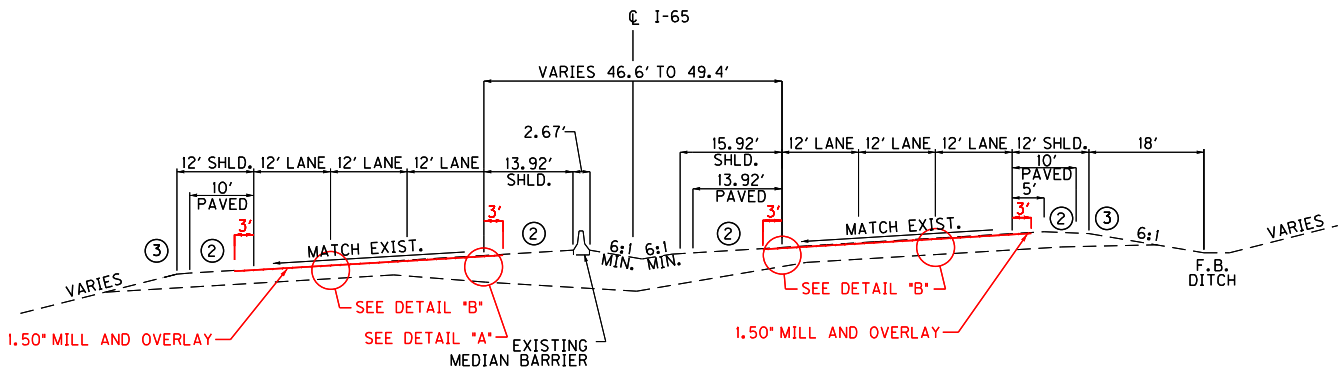
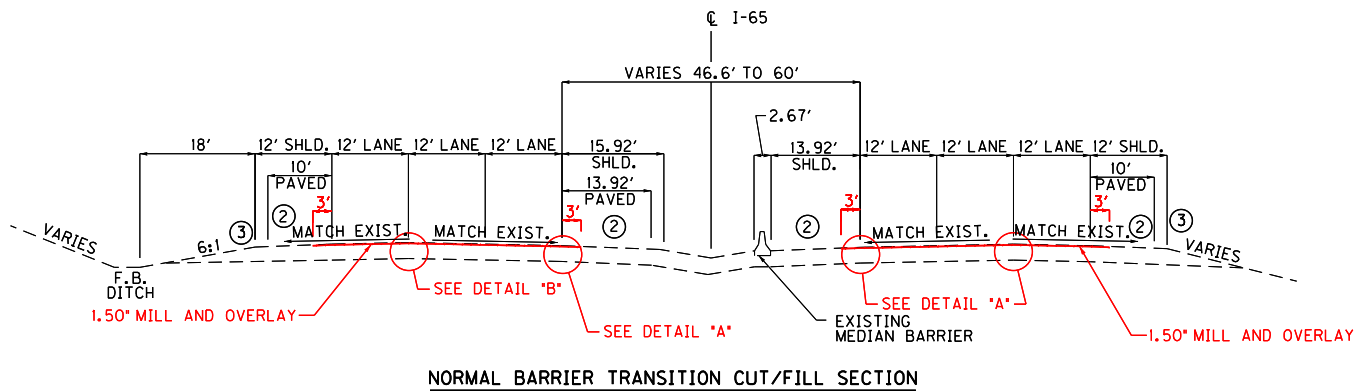

**NOTES**

- 1 CROSS SLOPES BASED ON RECORD PLANS.
- 2 FROM EDGE OF MILL AND OVERLAY TO EDGE OF PAVED SHOULDER, APPLY ASPHALT EMULSION FOR FOG SEAL. SEE SPECIAL NOTE FOR FOG SEAL.
- 3 IN AREAS WITHOUT EXISTING GUARDRAIL, ASPHALT SEAL REQUIRED FROM OUTSIDE EDGE OF PAVED SHOULDER TO A POINT 2 FEET DOWN THE DITCH OR FILL SLOPE. TWO APPLICATIONS OF THE FOLLOWING:  
 ASPHALT SEAL COAT @ 2.40 LBS. /SQ. YD.  
 ASPHALT SEAL AGGREGATE @ 20 LBS. /SQ. YD.

NOT TO SCALE

PROPOSED TYPICAL SECTIONS  
SHEET 2 OF 6

COUNTY OF	ITEM NO.
WARREN	3-20016.00

# PROPOSED TYPICAL SECTIONS

MP 21.0 TO MP 22.1

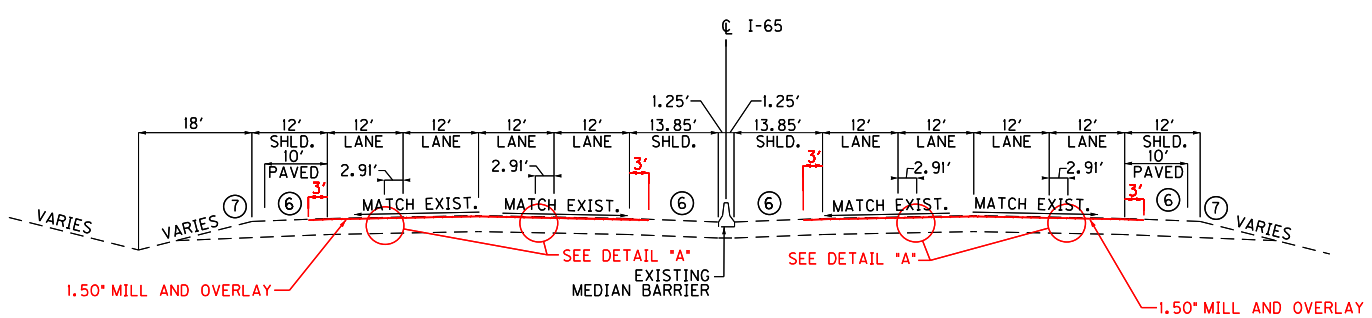

NORMAL EIGHT LANE CUT/FILL SECTION

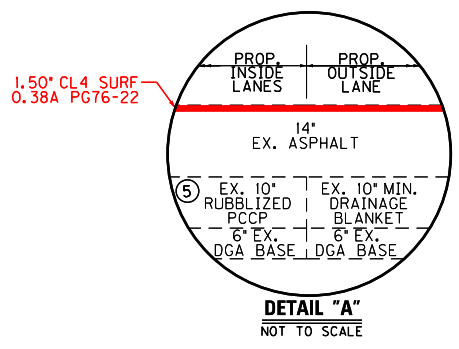

NOTES

- 1 TRAVEL LANES AND OUTSIDE SHOULDERS VARY FROM 11.81' TO 12'.
- 2 PAVED SHOULDERS VARY FROM 9.84' TO 10'.
- 3 DITCH OFFSET VARIES 18.0' TO 17.72'.
- 4 CROSS SLOPES BASED ON RECORD PLANS.
- ⑤ EXISTING PCCP IS BROKEN AND SEATED AT MP 21.950 TO MP 22.1.
- ⑥ FROM EDGE OF MILL AND OVERLAY TO EDGE OF PAVED SHOULDER, APPLY ASPHALT EMULSION FOR FOG SEAL . SEE SPECIAL NOTE FOR FOG SEAL.
- ⑦ IN AREAS WITHOUT EXISTING GUARDRAIL, ASPHALT SEAL REQUIRED FROM OUTSIDE EDGE OF PAVED SHOULDER TO A POINT 2 FEET DOWN THE DITCH OR FILL SLOPE. TWO APPLICATIONS OF THE FOLLOWING:  
 ASPHALT SEAL COAT @ 2.40 LBS. /SQ. YD.  
 ASPHALT SEAL AGGREGATE @ 20 LBS. /SQ. YD.

NOT TO SCALE

PROPOSED TYPICAL SECTIONS  
SHEET 3 OF 6

COUNTY OF	ITEM NO.
WARREN	3-20016.00

# PROPOSED TYPICAL SECTIONS

MP 23.6 TO MP 24.8

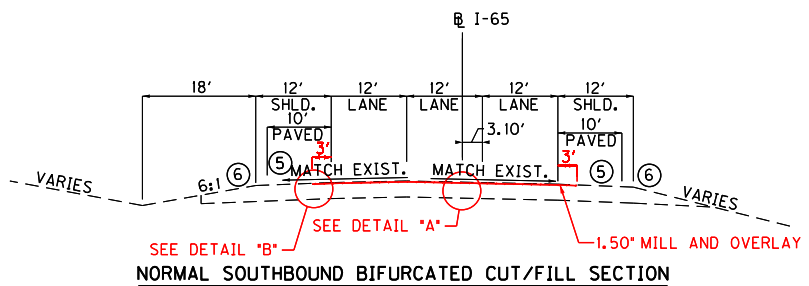

**NORMAL SOUTHBOUND BIFURCATED CUT/FILL SECTION**

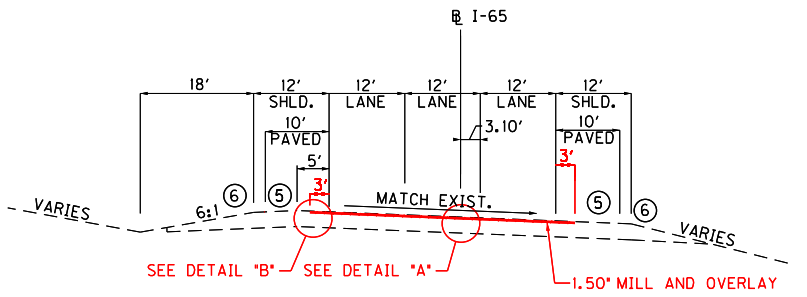

**LEFT SUPERELEVATED SOUTHBOUND BIFURCATED CUT/FILL SECTION**

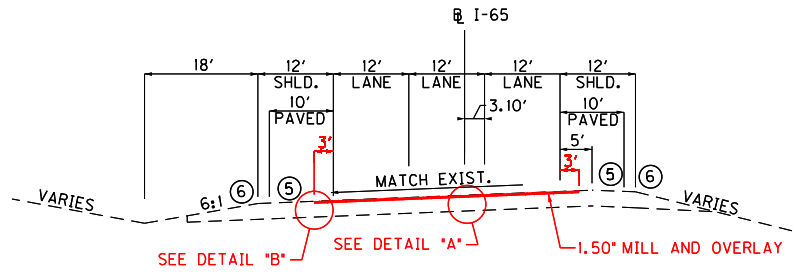

**RIGHT SUPERELEVATED SOUTHBOUND BIFURCATED CUT/FILL SECTION**

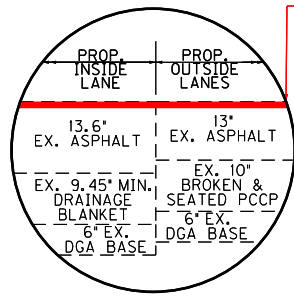

**DETAIL "A"**  
NOT TO SCALE

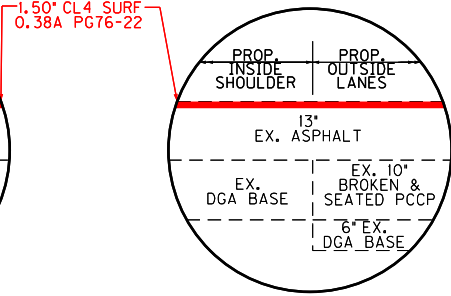

**DETAIL "B"**  
NOT TO SCALE

**NOTES**

- 1 TRAVEL LANES AND SHOULDERS VARY FROM 11.81' TO 12'.
- 2 PAVED SHOULDERS VARY FROM 9.84' TO 10'.
- 3 DITCH OFFSET VARIES 18.0' TO 17.72'.
- 4 CROSS SLOPES BASED ON RECORD PLANS.
- 5 FROM EDGE OF MILL AND OVERLAY TO EDGE OF PAVED SHOULDER, APPLY ASPHALT EMULSION FOR FOG SEAL . SEE SPECIAL NOTE FOR FOG SEAL.
- 6 IN AREAS WITHOUT EXISTING GUARDRAIL, ASPHALT SEAL REQUIRED FROM OUTSIDE EDGE OF PAVED SHOULDER TO A POINT 2 FEET DOWN THE DITCH OR FILL SLOPE. TWO APPLICATIONS OF THE FOLLOWING:  
 ASPHALT SEAL COAT @ 2.40 LBS. /SQ. YD.  
 ASPHALT SEAL AGGREGATE @ 20 LBS. /SQ. YD.

NOT TO SCALE

PROPOSED TYPICAL SECTIONS  
SHEET 4 OF 6

COUNTY OF	ITEM NO.
WARREN	3-20016.00

# PROPOSED TYPICAL SECTIONS

MP 23.6 TO MP 24.8

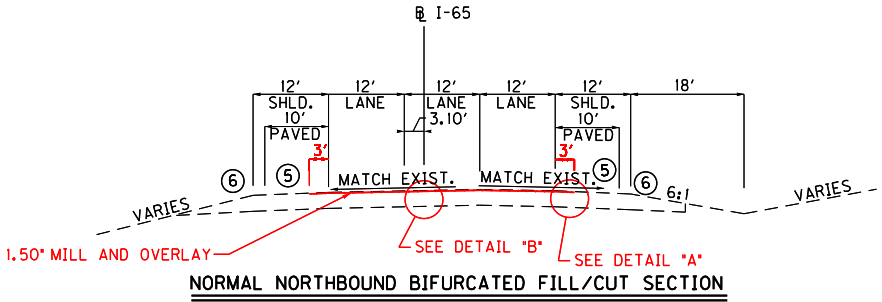

**NORMAL NORTHBOUND BIFURCATED FILL/CUT SECTION**

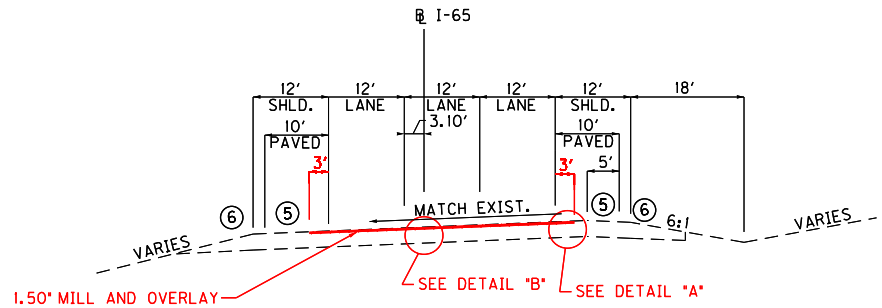

**SUPERELEVATED RIGHT NORTHBOUND BIFURCATED FILL/CUT SECTION**

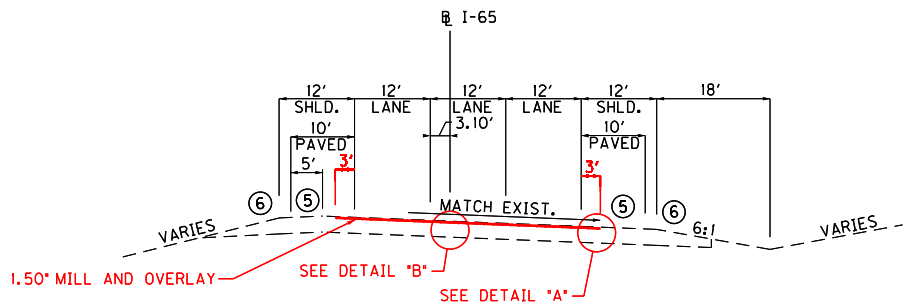

**SUPERELEVATED LEFT NORTHBOUND BIFURCATED FILL/CUT SECTION**

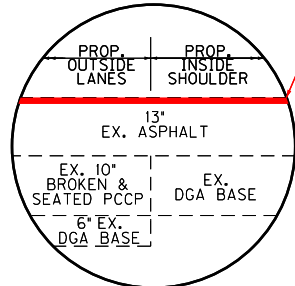

**DETAIL "A"**  
NOT TO SCALE

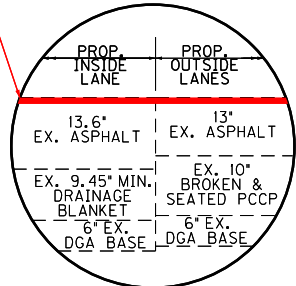

**DETAIL "B"**  
NOT TO SCALE

**NOTES**

- 1 TRAVEL LANES AND SHOULDERS VARY FROM 11.81' TO 12'.
- 2 PAVED SHOULDERS VARY FROM 9.84' TO 10'.
- 3 DITCH OFFSET VARIES 18.0' TO 17.72'.
- 4 CROSS SLOPES BASED ON RECORD PLANS.
- ⑤ FROM EDGE OF MILL AND OVERLAY TO EDGE OF PAVED SHOULDER, APPLY ASPHALT EMULSION FOR FOG SEAL. SEE SPECIAL NOTE FOR FOG SEAL.
- ⑥ IN AREAS WITHOUT EXISTING GUARDRAIL, ASPHALT SEAL REQUIRED FROM OUTSIDE EDGE OF PAVED SHOULDER TO A POINT 2 FEET DOWN THE DITCH OR FILL SLOPE. TWO APPLICATIONS OF THE FOLLOWING:  
 ASPHALT SEAL COAT @ 2.40 LBS. /SQ. YD.  
 ASPHALT SEAL AGGREGATE @ 20 LBS. /SQ. YD.

NOT TO SCALE

**PROPOSED TYPICAL SECTIONS**  
SHEET 5 OF 6

COUNTY OF	ITEM NO.
WARREN	3-20016.00

# PROPOSED TYPICAL SECTIONS

I-65 AND US 231 INTERCHANGE

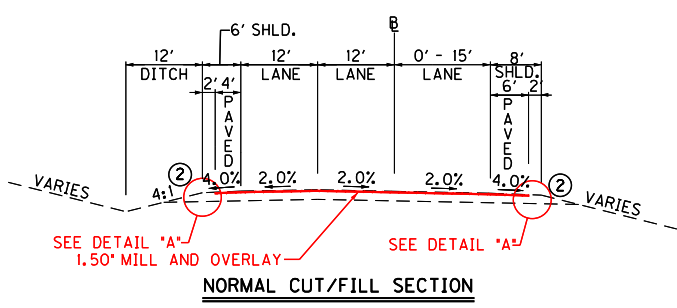

**NORMAL CUT/FILL SECTION**

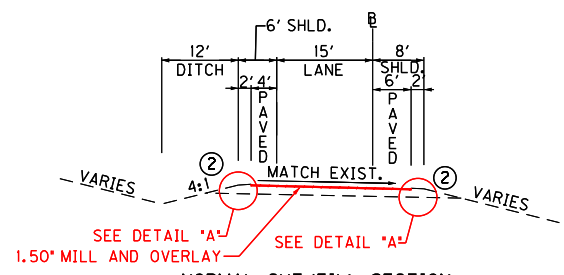

**NORMAL CUT/FILL SECTION**

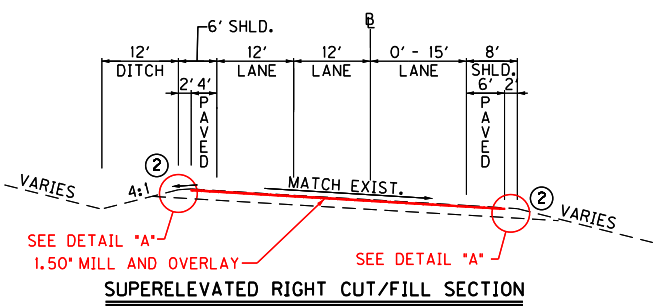

**SUPERELEVATED RIGHT CUT/FILL SECTION**

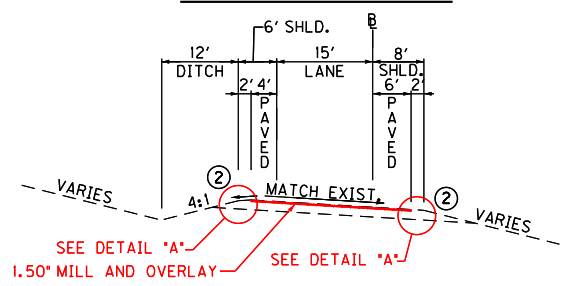

**SUPERELEVATED RIGHT CUT/FILL SECTION**

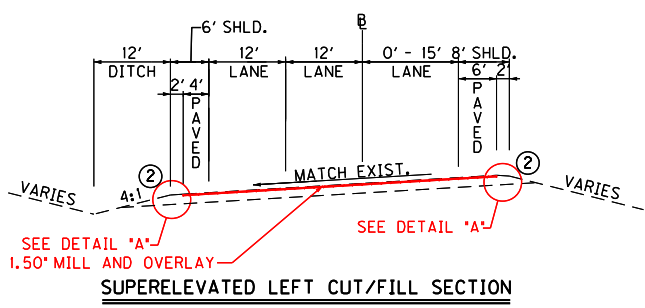

**SUPERELEVATED LEFT CUT/FILL SECTION**

**TWO LANE RAMP  
RAMPS A, B, C, & D**

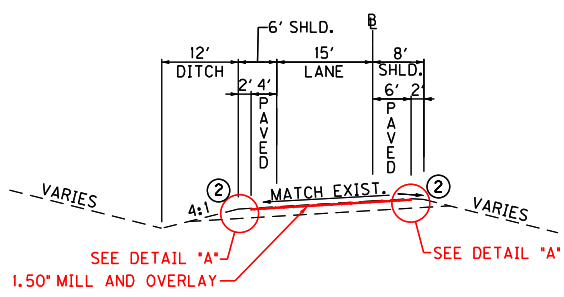

**SUPERELEVATED LEFT CUT/FILL SECTION**

**ONE LANE RAMP  
RAMPS A1, B1, C1, & D1**

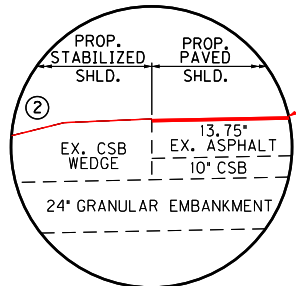

**DETAIL "A"**  
NOT TO SCALE

**NOTES**

- 1 CROSS SLOPES BASED ON RECORD PLANS.
- ② IN AREAS WITHOUT EXISTING GUARDRAIL ASPHALT SEAL REQUIRED FROM OUTSIDE EDGE OF PAVED SHOULDER TO A POINT 2 FEET DOWN THE DITCH OR FILL SLOPE. TWO APPLICATIONS OF THE FOLLOWING:  
ASPHALT SEAL COAT @ 2.40 LBS. /SQ. YD.  
ASPHALT SEAL AGGREGATE @ 20 LBS. /SQ. YD.
- 3 PAVED SHOULDER EXTENDS TO FACE OF GUARDRAIL.

NOT TO SCALE

PROPOSED TYPICAL SECTIONS  
SHEET 6 OF 6

COUNTY OF	ITEM NO.
WARREN	3-20016.00



17+00  
16+00  
15+00  
14+00  
13+00  
12+00  
11+00  
10+00  
9+00  
8+00  
7+00  
6+00  
5+00  
4+00  
3+00  
2+00  
1+00  
0+00

- PAVED DITCH TO BE REMOVED
- FILL SLOPE EROSION REPAIR
- MEDIAN EROSION REPAIR
- CUT SLOPE EROSION REPAIR
- MAJOR PAVEMENT BLOW UP REPAIR
- MINOR PAVEMENT BLOW UP REPAIR
- REPLACE DRAINAGE GRATE
- EXISTING GUARDRAIL TO REMAIN

CL I-65

PT 8+64.63

PT 4+33.14

POB 0+00.00

WARREN COUNTY  
SIMPSON COUNTY

BEGIN CONSTRUCTION  
MP 13.711

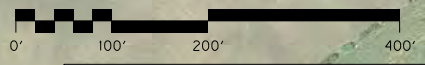

SCALE: 1"=200'

I-65  
WARREN COUNTY  
PLAN SHEET 1 OF 33

COUNTY OF	ITEM NO.
WARREN	3-20016.00

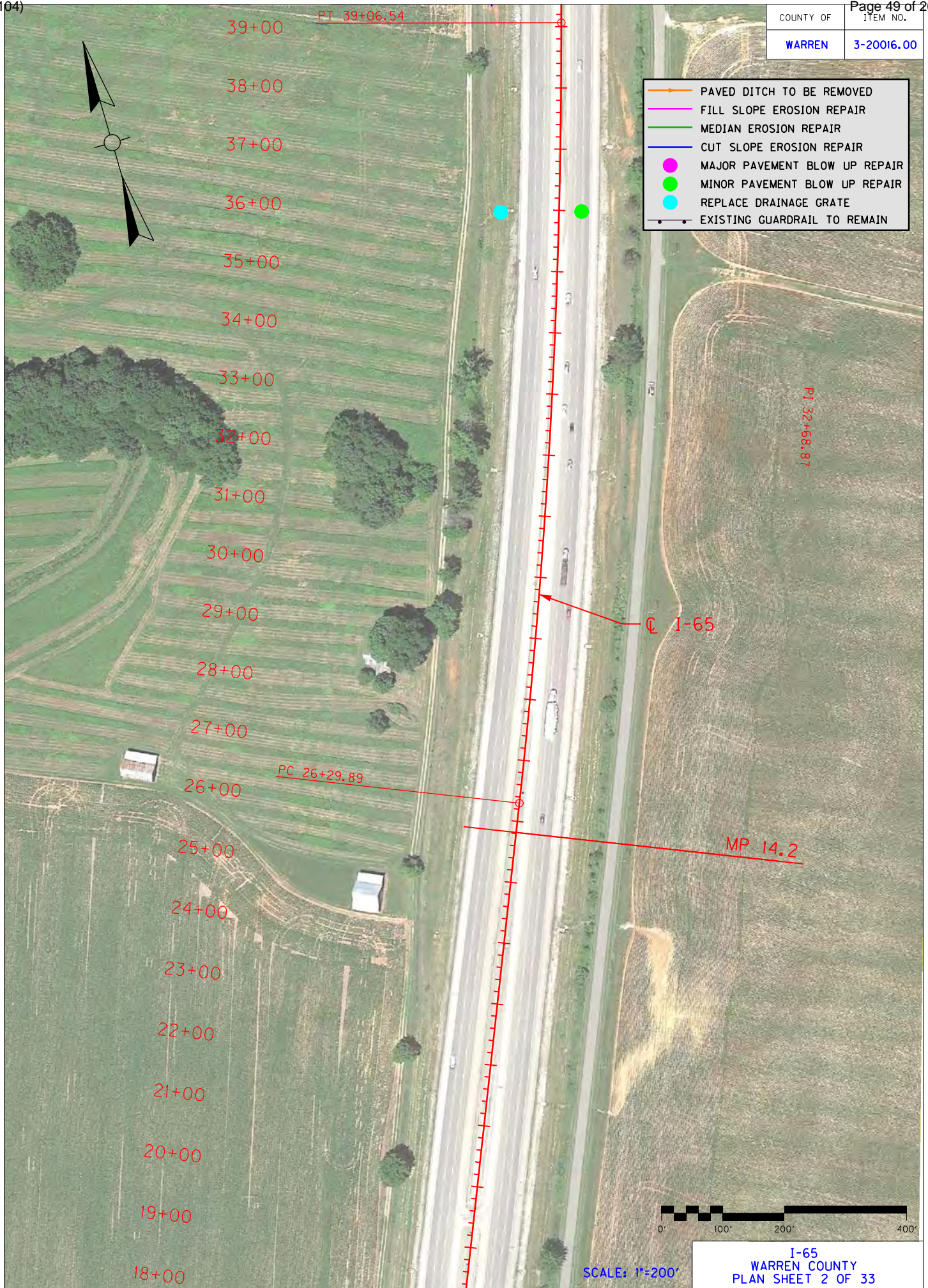

- PAVED DITCH TO BE REMOVED
- FILL SLOPE EROSION REPAIR
- MEDIAN EROSION REPAIR
- CUT SLOPE EROSION REPAIR
- MAJOR PAVEMENT BLOW UP REPAIR
- MINOR PAVEMENT BLOW UP REPAIR
- REPLACE DRAINAGE GRATE
- EXISTING GUARDRAIL TO REMAIN

39+00  
38+00  
37+00  
36+00  
35+00  
34+00  
33+00  
32+00  
31+00  
30+00  
29+00  
28+00  
27+00  
26+00  
25+00  
24+00  
23+00  
22+00  
21+00  
20+00  
19+00  
18+00

PT 39+06.54

PC 26+29.89

PI 32+68.87

I-65

MP 14.2



SCALE: 1"=200'

I-65  
WARREN COUNTY  
PLAN SHEET 2 OF 33

COUNTY OF	ITEM NO.
WARREN	3-20016.00

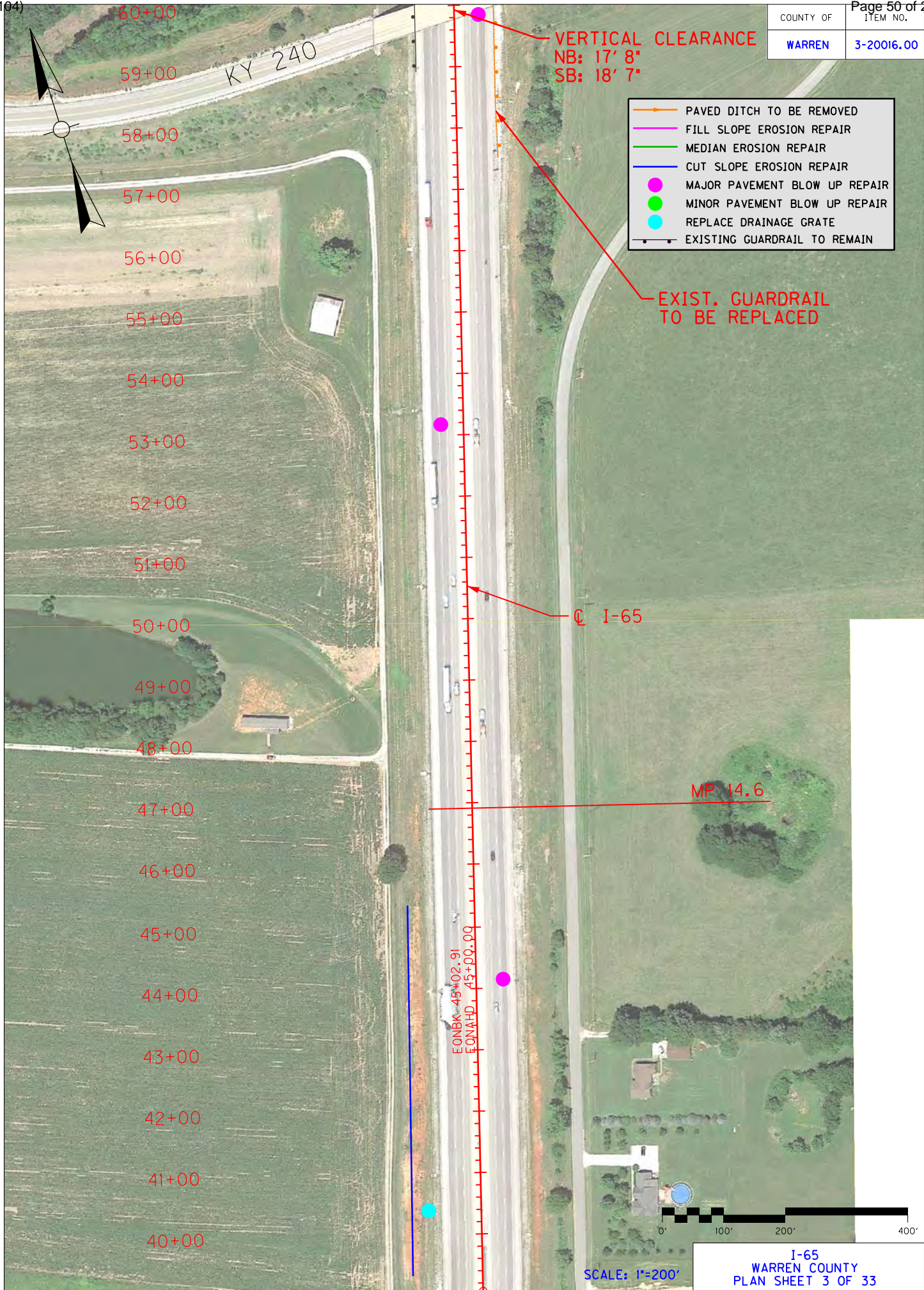

60+00  
59+00  
58+00  
57+00  
56+00  
55+00  
54+00  
53+00  
52+00  
51+00  
50+00  
49+00  
48+00  
47+00  
46+00  
45+00  
44+00  
43+00  
42+00  
41+00  
40+00

KY 240

VERTICAL CLEARANCE  
NB: 17' 8"  
SB: 18' 7"

- PAVED DITCH TO BE REMOVED
- FILL SLOPE EROSION REPAIR
- MEDIAN EROSION REPAIR
- CUT SLOPE EROSION REPAIR
- MAJOR PAVEMENT BLOW UP REPAIR
- MINOR PAVEMENT BLOW UP REPAIR
- REPLACE DRAINAGE GRATE
- EXISTING GUARDRAIL TO REMAIN

EXIST. GUARDRAIL TO BE REPLACED







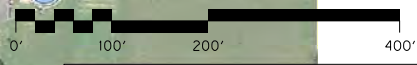

I-65

MP 14.6

EONBA-45+02.91  
EONAHD-45+00.00



COUNTY OF	ITEM NO.
WARREN	3-20016.00

-  PAVED DITCH TO BE REMOVED
-  FILL SLOPE EROSION REPAIR
-  MEDIAN EROSION REPAIR
-  CUT SLOPE EROSION REPAIR
-  MAJOR PAVEMENT BLOW UP REPAIR
-  MINOR PAVEMENT BLOW UP REPAIR
-  REPLACE DRAINAGE GRATE
-  EXISTING GUARDRAIL TO REMAIN

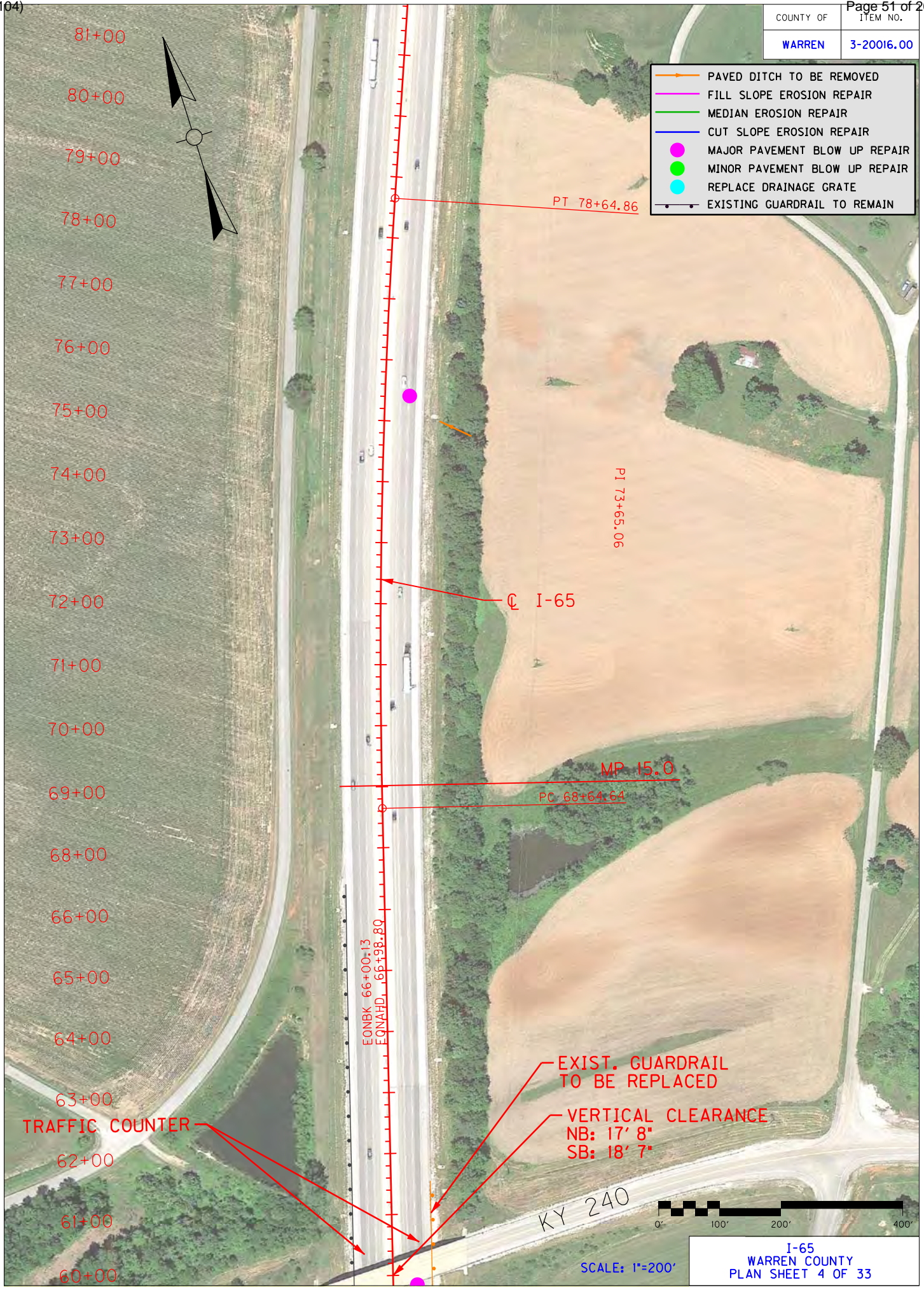

81+00  
80+00  
79+00  
78+00  
77+00  
76+00  
75+00  
74+00  
73+00  
72+00  
71+00  
70+00  
69+00  
68+00  
66+00  
65+00  
64+00  
63+00  
62+00  
61+00  
60+00

PT 78+64.86

PI 73+65.06

Ⓢ I-65

MP 15.0

PC 68+64.64

EONBK 66+00.13  
EQVALHD 66+98.80

TRAFFIC COUNTER

EXIST. GUARDRAIL  
TO BE REPLACED

VERTICAL CLEARANCE  
NB: 17' 8"  
SB: 18' 7"

KY 240

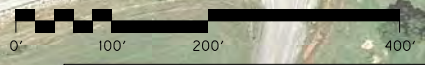

SCALE: 1"=200'

I-65  
WARREN COUNTY  
PLAN SHEET 4 OF 33

COUNTY OF	ITEM NO.
WARREN	3-20016.00

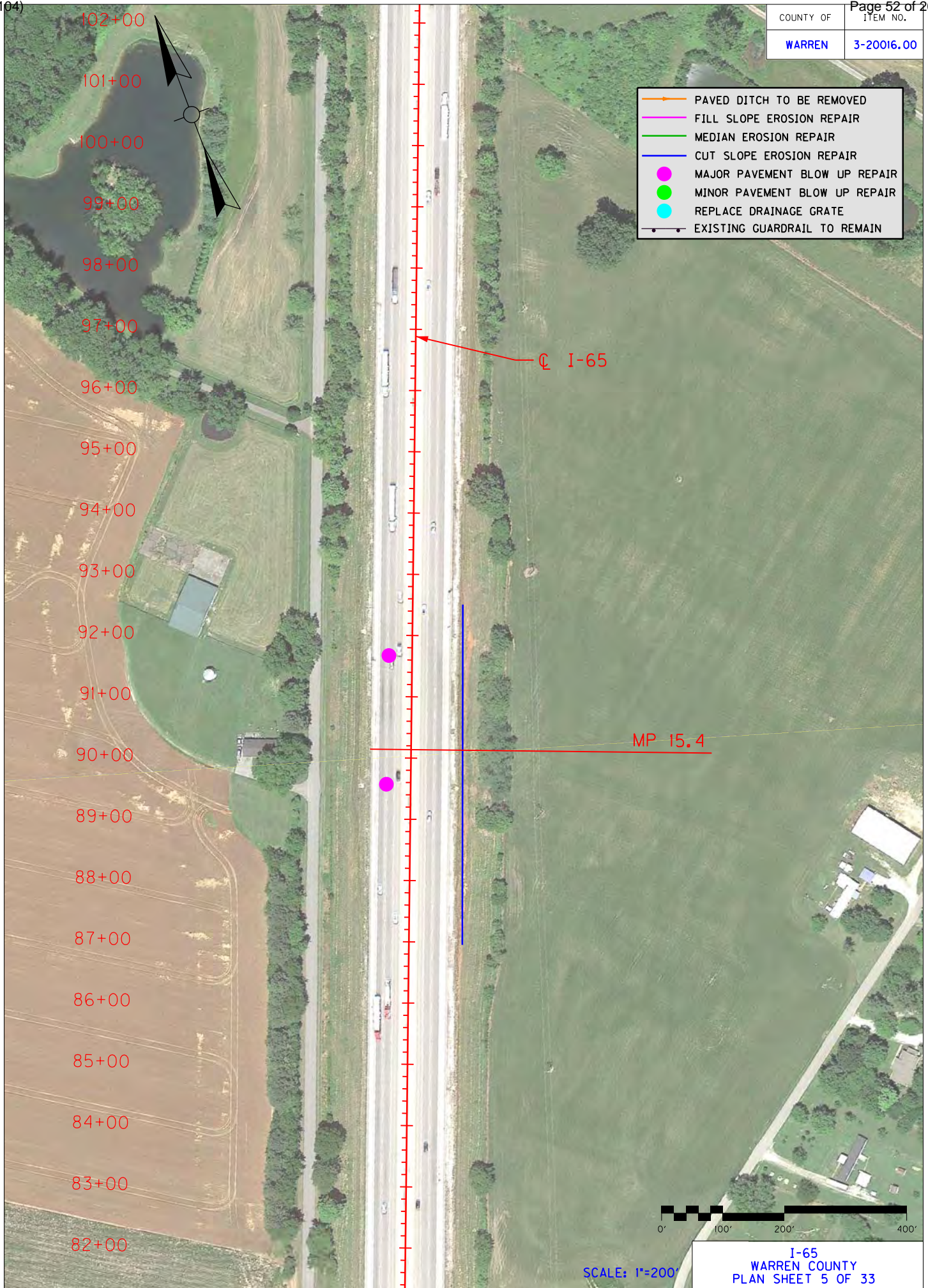



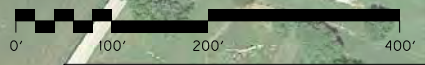



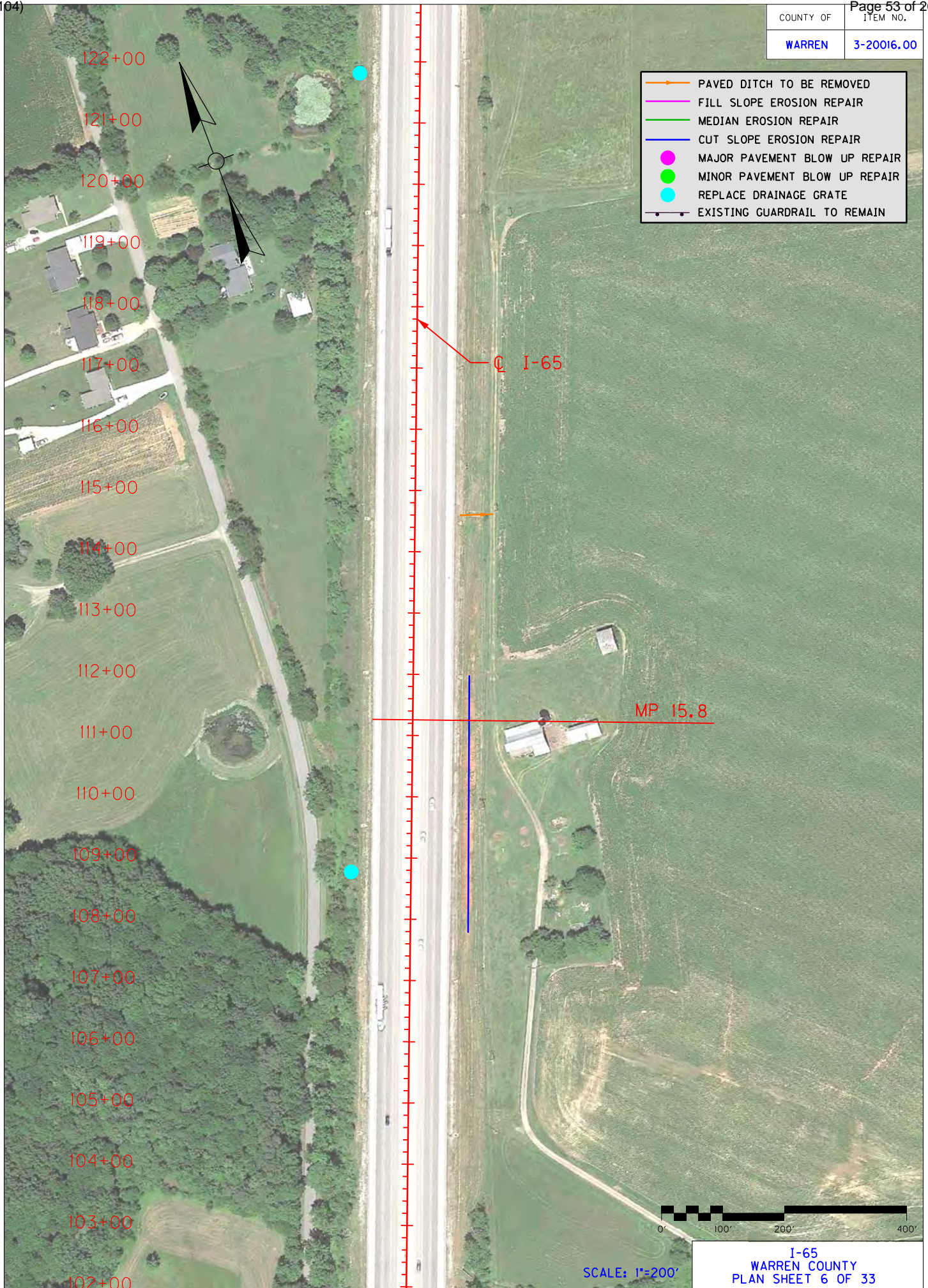

- PAVED DITCH TO BE REMOVED
- FILL SLOPE EROSION REPAIR
- MEDIAN EROSION REPAIR
- CUT SLOPE EROSION REPAIR
- MAJOR PAVEMENT BLOW UP REPAIR
- MINOR PAVEMENT BLOW UP REPAIR
- REPLACE DRAINAGE GRATE
- EXISTING GUARDRAIL TO REMAIN



COUNTY OF	ITEM NO.
WARREN	3-20016.00



-  PAVED DITCH TO BE REMOVED
-  FILL SLOPE EROSION REPAIR
-  MEDIAN EROSION REPAIR
-  CUT SLOPE EROSION REPAIR
-  MAJOR PAVEMENT BLOW UP REPAIR
-  MINOR PAVEMENT BLOW UP REPAIR
-  REPLACE DRAINAGE GRATE
-  EXISTING GUARDRAIL TO REMAIN

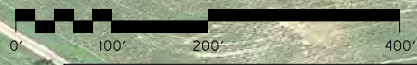

SCALE: 1"=200'  
I-65  
WARREN COUNTY  
PLAN SHEET 6 OF 33

COUNTY OF	ITEM NO.
WARREN	3-20016.00

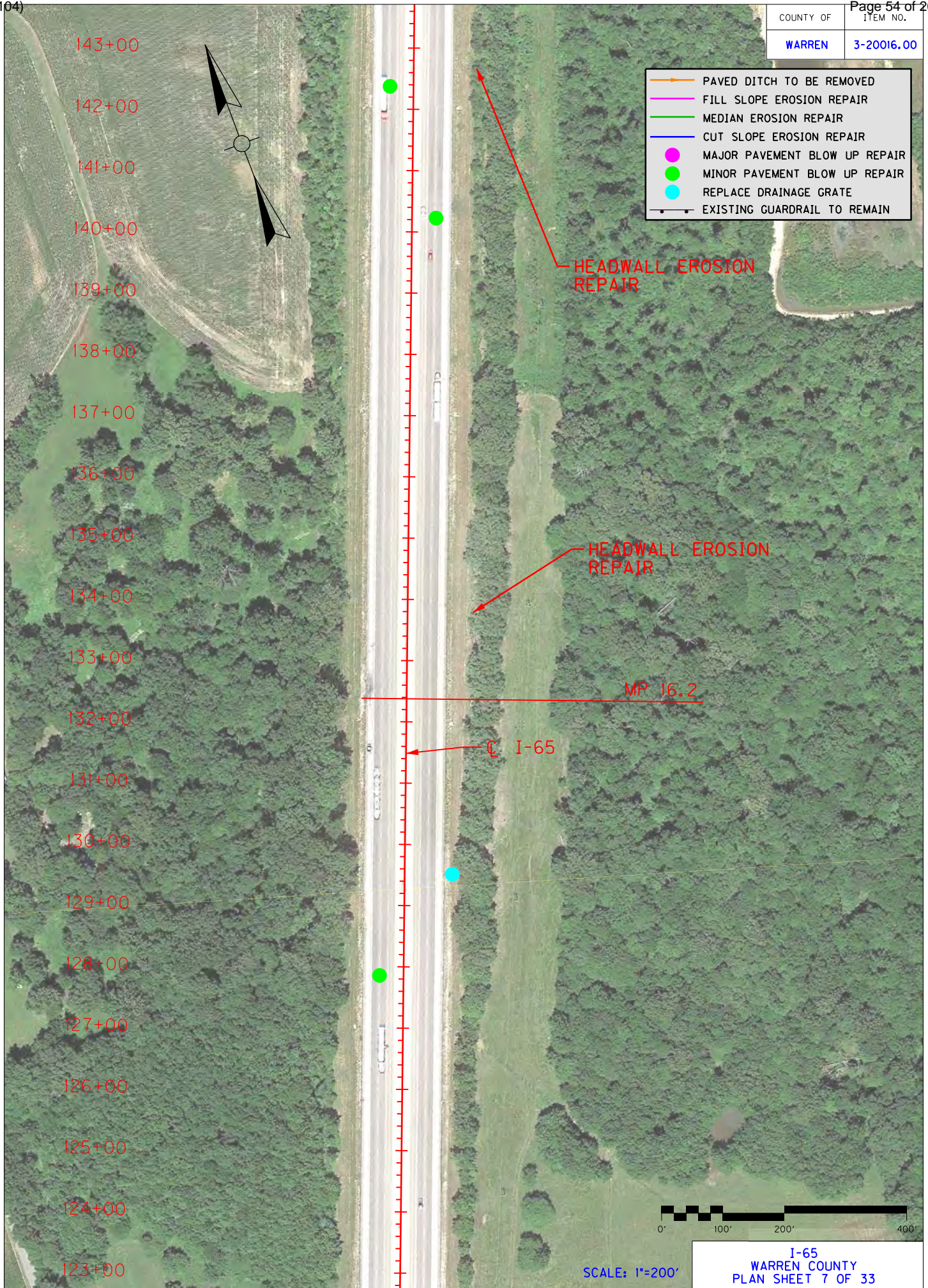

- PAVED DITCH TO BE REMOVED
- FILL SLOPE EROSION REPAIR
- MEDIAN EROSION REPAIR
- CUT SLOPE EROSION REPAIR
- MAJOR PAVEMENT BLOW UP REPAIR
- MINOR PAVEMENT BLOW UP REPAIR
- REPLACE DRAINAGE GRATE
- EXISTING GUARDRAIL TO REMAIN

HEADWALL EROSION REPAIR

HEADWALL EROSION REPAIR

MP 16.2

I-65

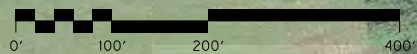

SCALE: 1"=200'

I-65  
WARREN COUNTY  
PLAN SHEET 7 OF 33

COUNTY OF	ITEM NO.
WARREN	3-20016.00

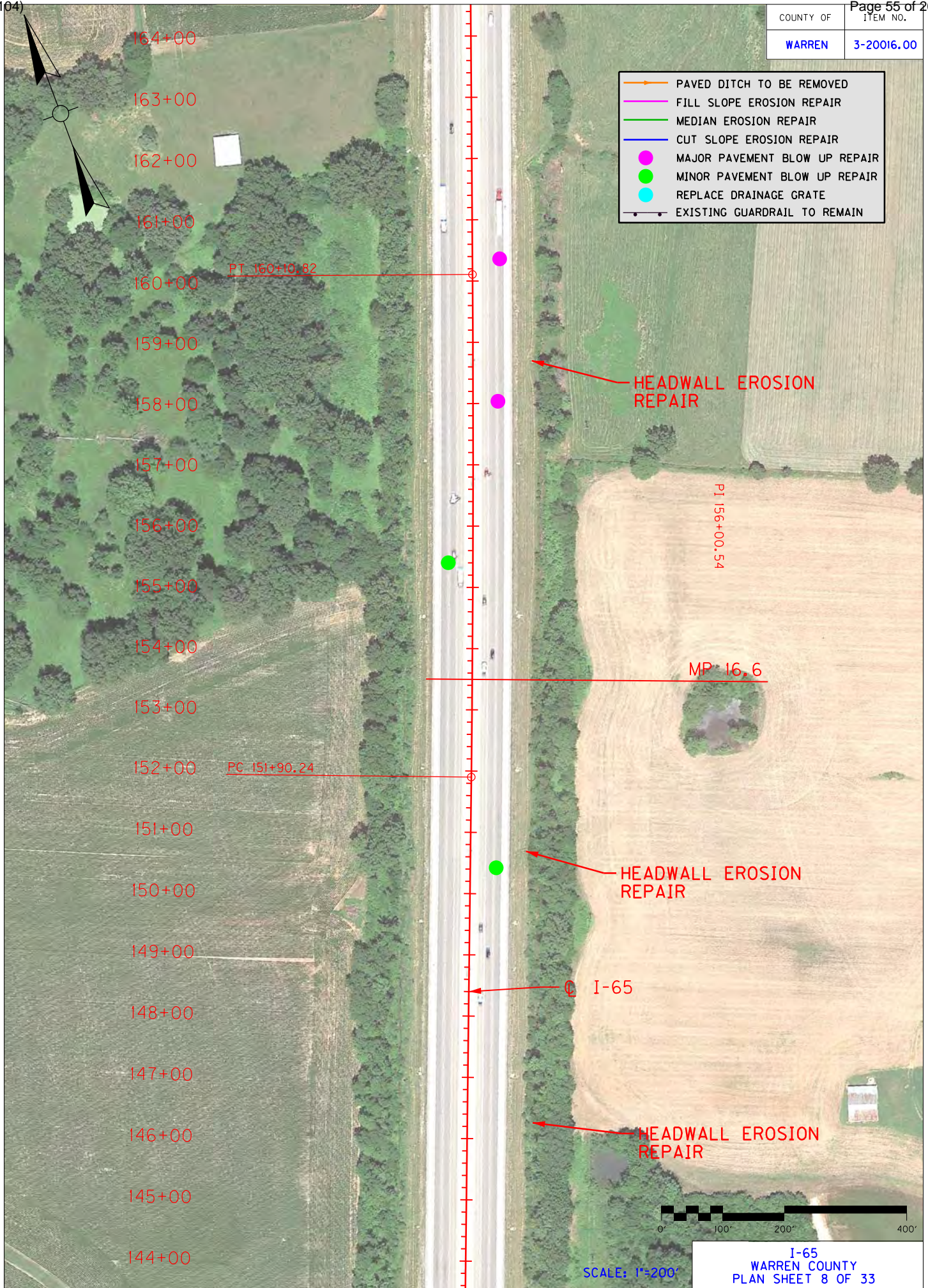

- PAVED DITCH TO BE REMOVED
- FILL SLOPE EROSION REPAIR
- MEDIAN EROSION REPAIR
- CUT SLOPE EROSION REPAIR
- MAJOR PAVEMENT BLOW UP REPAIR
- MINOR PAVEMENT BLOW UP REPAIR
- REPLACE DRAINAGE GRATE
- EXISTING GUARDRAIL TO REMAIN

164+00  
163+00  
162+00  
161+00  
160+00  
159+00  
158+00  
157+00  
156+00  
155+00  
154+00  
153+00  
152+00  
151+00  
150+00  
149+00  
148+00  
147+00  
146+00  
145+00  
144+00

PT. 160+10.82

PC. 151+90.24

PT. 156+00.54

MP. 16.6

I-65









HEADWALL EROSION REPAIR

HEADWALL EROSION REPAIR

HEADWALL EROSION REPAIR







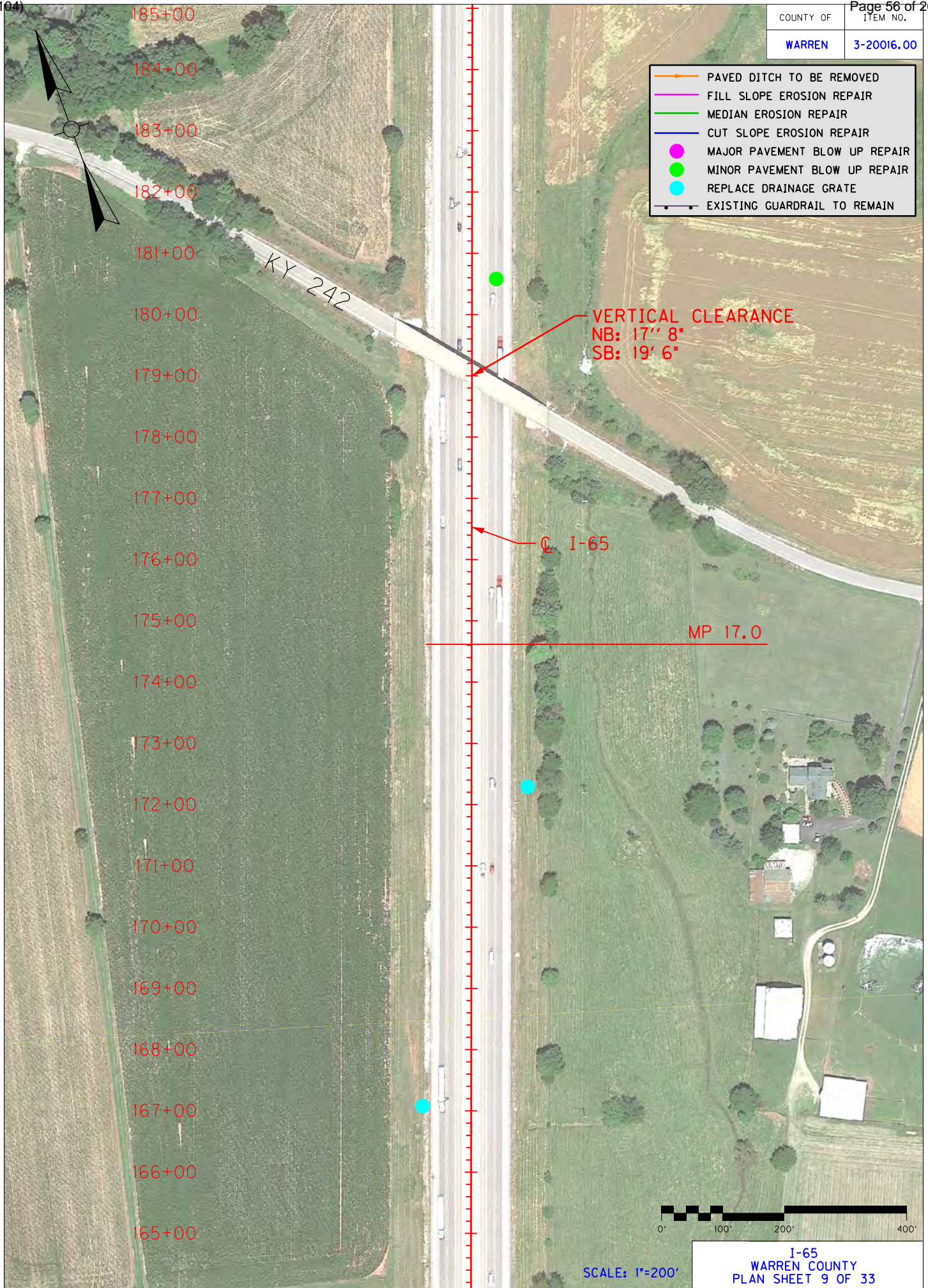

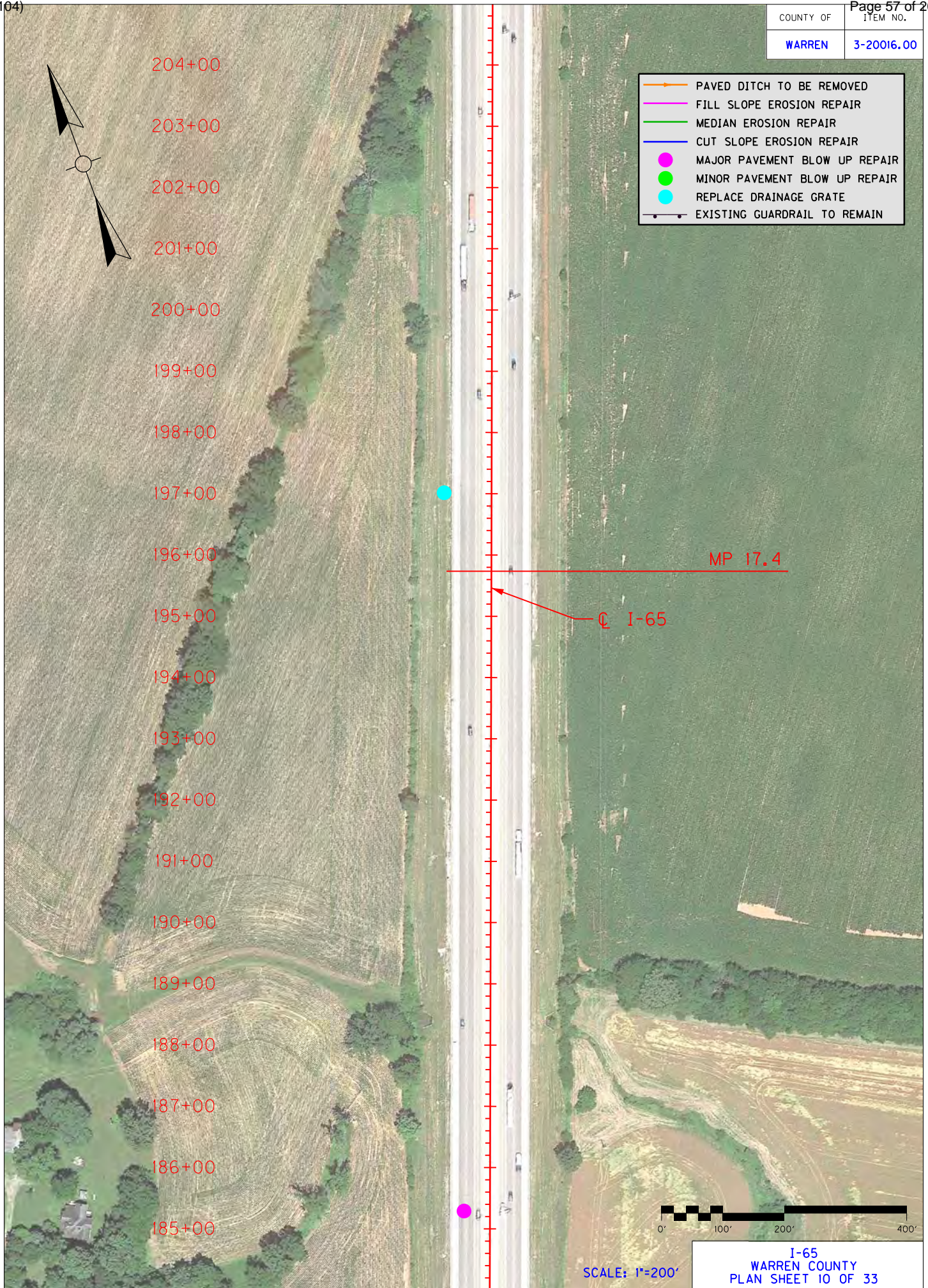

COUNTY OF	ITEM NO.
WARREN	3-20016.00

-  PAVED DITCH TO BE REMOVED
-  FILL SLOPE EROSION REPAIR
-  MEDIAN EROSION REPAIR
-  CUT SLOPE EROSION REPAIR
-  MAJOR PAVEMENT BLOW UP REPAIR
-  MINOR PAVEMENT BLOW UP REPAIR
-  REPLACE DRAINAGE GRATE
-  EXISTING GUARDRAIL TO REMAIN



COUNTY OF	ITEM NO.
WARREN	3-20016.00



-  PAVED DITCH TO BE REMOVED
-  FILL SLOPE EROSION REPAIR
-  MEDIAN EROSION REPAIR
-  CUT SLOPE EROSION REPAIR
-  MAJOR PAVEMENT BLOW UP REPAIR
-  MINOR PAVEMENT BLOW UP REPAIR
-  REPLACE DRAINAGE GRATE
-  EXISTING GUARDRAIL TO REMAIN

204+00  
203+00  
202+00  
201+00  
200+00  
199+00  
198+00  
197+00  
196+00  
195+00  
194+00  
193+00  
192+00  
191+00  
190+00  
189+00  
188+00  
187+00  
186+00  
185+00

MP 17.4

CL I-65



SCALE: 1"=200'

I-65  
WARREN COUNTY  
PLAN SHEET 10 OF 33

COUNTY OF	ITEM NO.
WARREN	3-20016.00

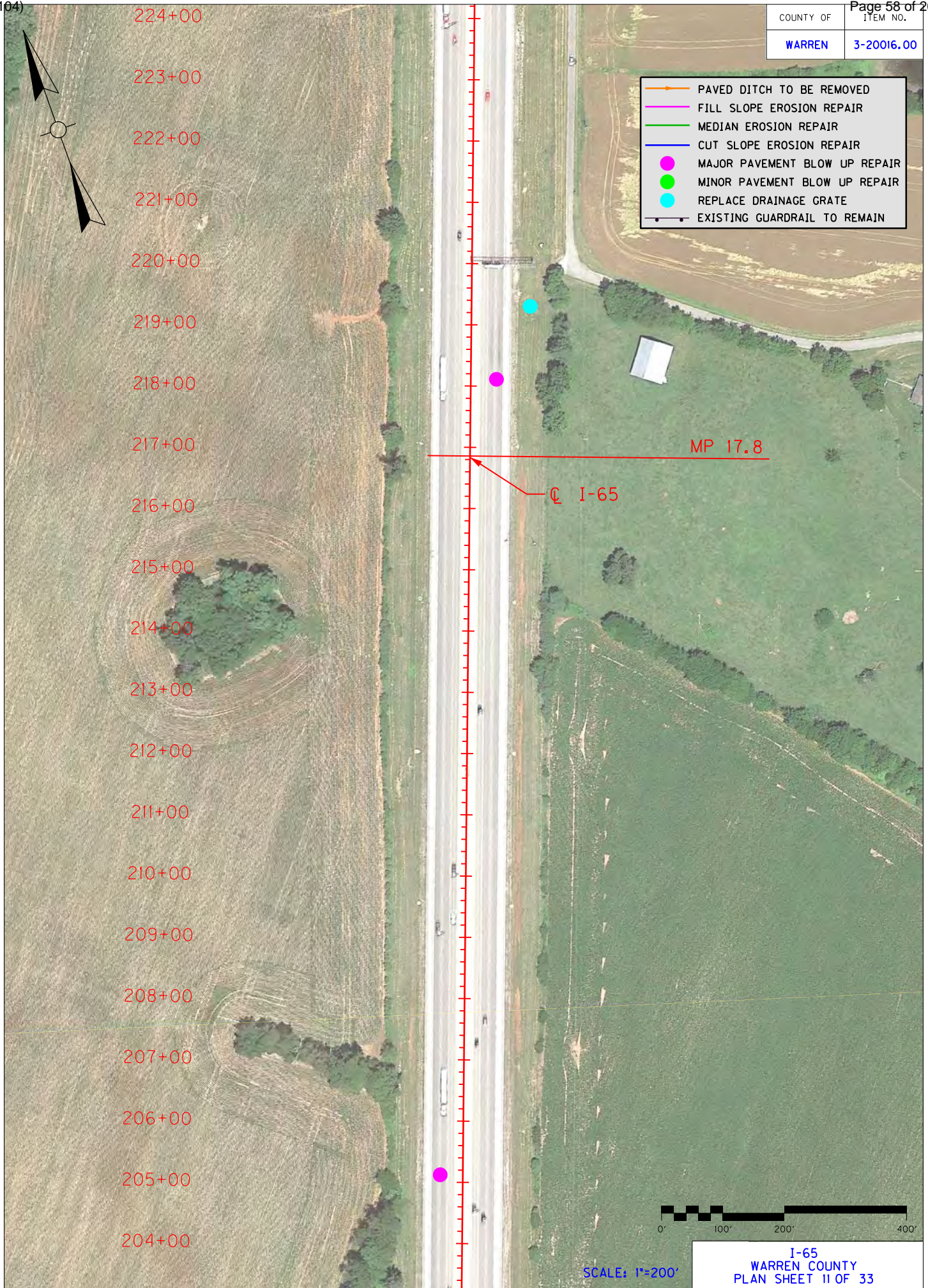

- PAVED DITCH TO BE REMOVED
- FILL SLOPE EROSION REPAIR
- MEDIAN EROSION REPAIR
- CUT SLOPE EROSION REPAIR
- MAJOR PAVEMENT BLOW UP REPAIR
- MINOR PAVEMENT BLOW UP REPAIR
- REPLACE DRAINAGE GRATE
- EXISTING GUARDRAIL TO REMAIN

MP 17.8

CL I-65



COUNTY OF	ITEM NO.
WARREN	3-20016.00

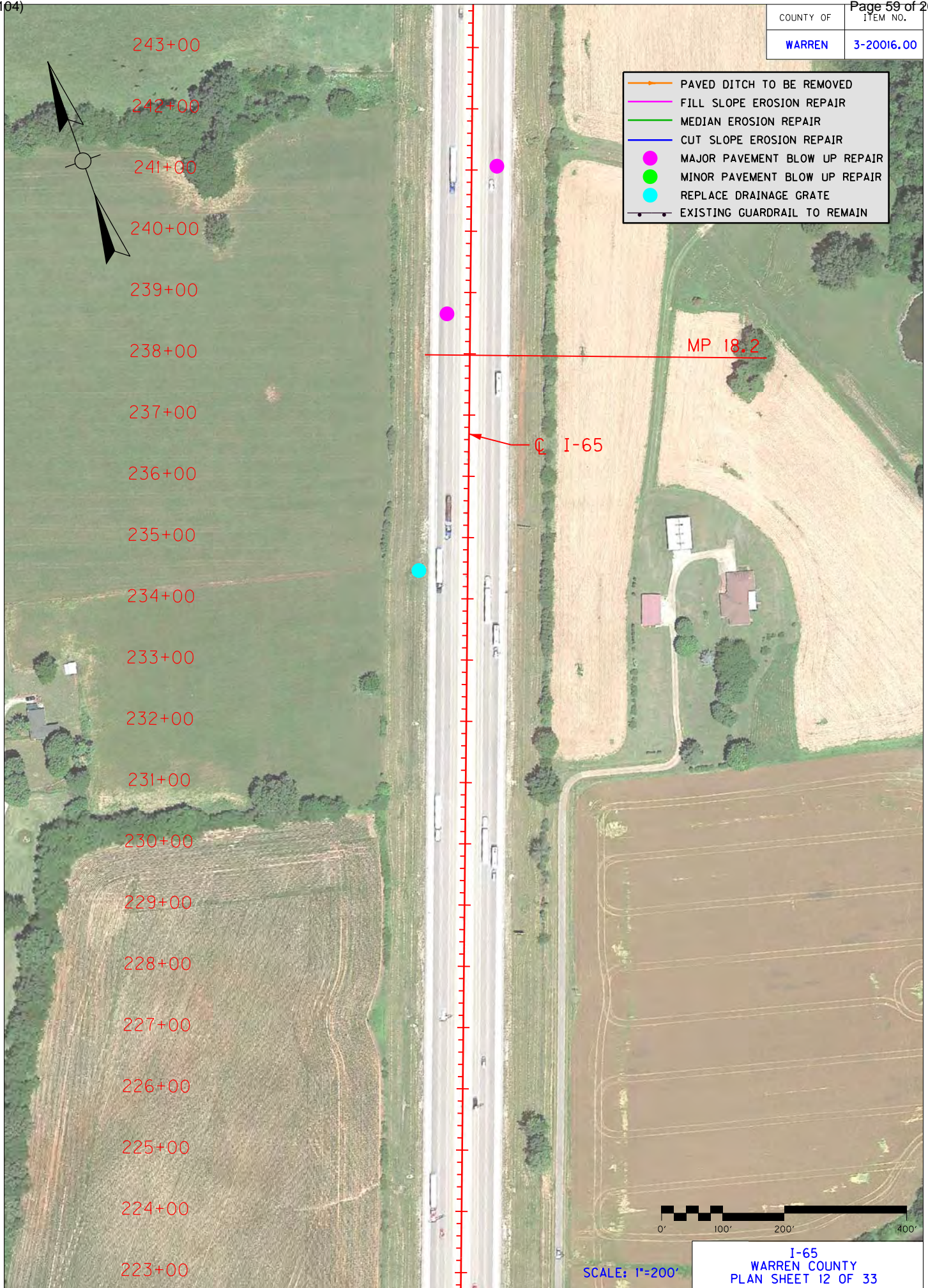

COUNTY OF	ITEM NO.
WARREN	3-20016.00

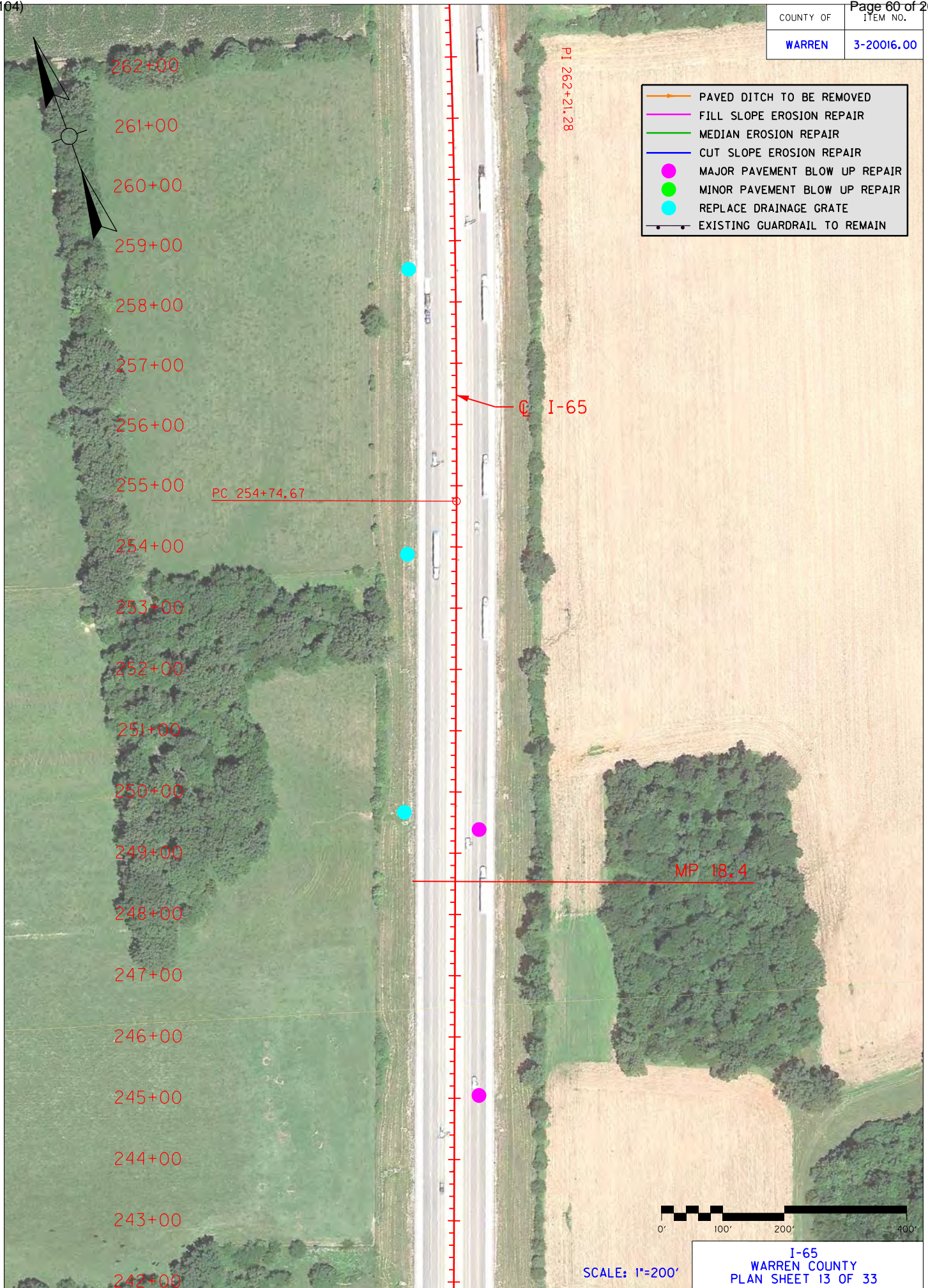

- PAVED DITCH TO BE REMOVED
- FILL SLOPE EROSION REPAIR
- MEDIAN EROSION REPAIR
- CUT SLOPE EROSION REPAIR
- MAJOR PAVEMENT BLOW UP REPAIR
- MINOR PAVEMENT BLOW UP REPAIR
- REPLACE DRAINAGE GRATE
- EXISTING GUARDRAIL TO REMAIN

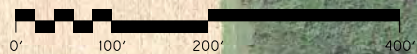

SCALE: 1"=200'  
I-65  
WARREN COUNTY  
PLAN SHEET 13 OF 33

COUNTY OF	ITEM NO.
WARREN	3-20016.00

- PAVED DITCH TO BE REMOVED
- FILL SLOPE EROSION REPAIR
- MEDIAN EROSION REPAIR
- CUT SLOPE EROSION REPAIR
- MAJOR PAVEMENT BLOW UP REPAIR
- MINOR PAVEMENT BLOW UP REPAIR
- REPLACE DRAINAGE GRATE
- EXISTING GUARDRAIL TO REMAIN

282+00  
281+00  
280+00  
279+00  
278+00  
277+00  
276+00  
275+00  
274+00  
273+00  
272+00  
271+00  
270+00  
269+00  
268+00  
267+00  
266+00  
265+00  
264+00  
263+00  
262+00

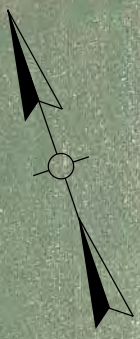

Q I-65

MP 18.8

PT 269+67.36



SCALE: 1"=200'

I-65  
WARREN COUNTY  
PLAN SHEET 14 OF 33

COUNTY OF	ITEM NO.
WARREN	3-20016.00

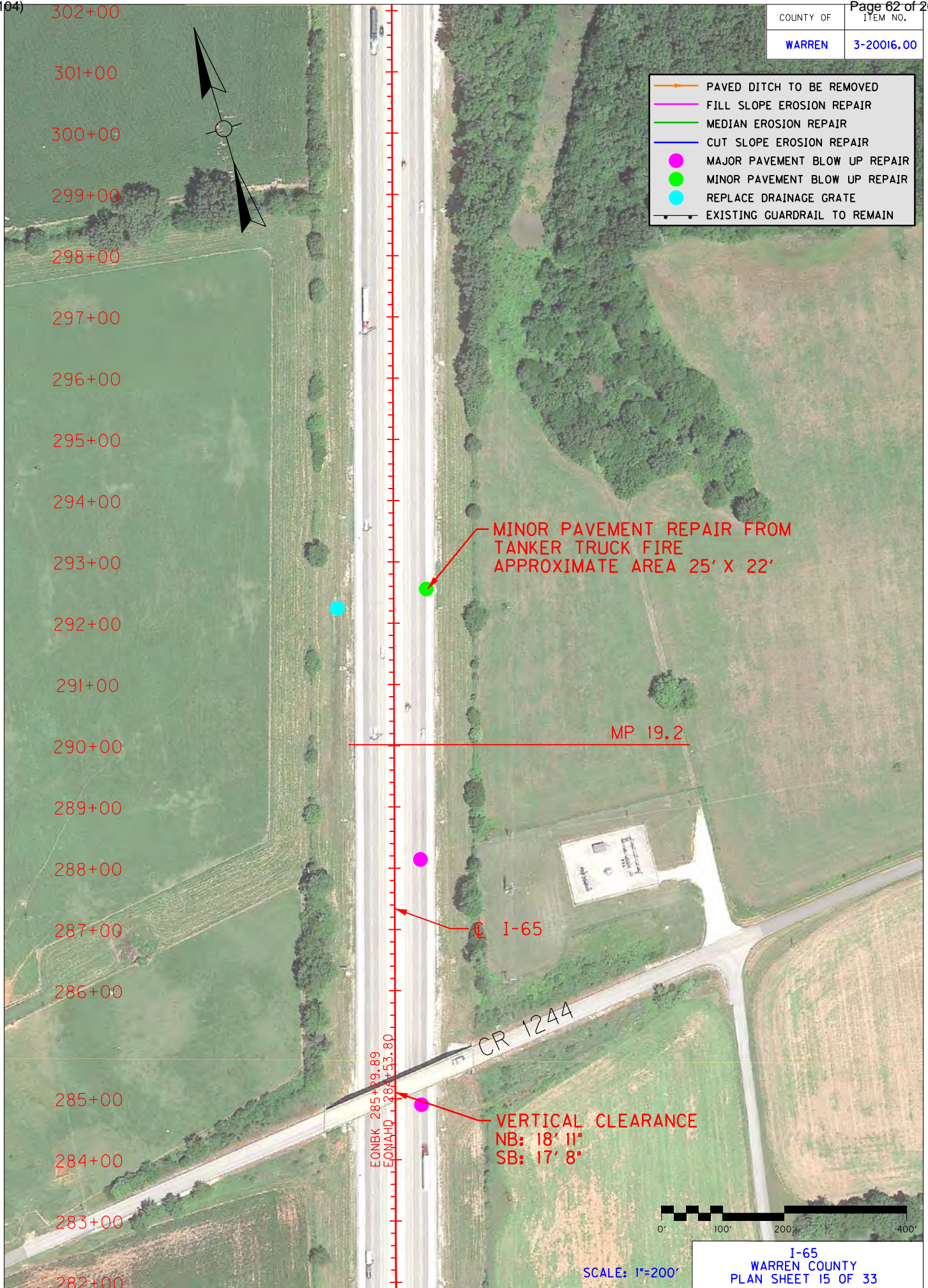

302+00  
301+00  
300+00  
299+00  
298+00  
297+00  
296+00  
295+00  
294+00  
293+00  
292+00  
291+00  
290+00  
289+00  
288+00  
287+00  
286+00  
285+00  
284+00  
283+00  
282+00

MINOR PAVEMENT REPAIR FROM  
TANKER TRUCK FIRE  
APPROXIMATE AREA 25' X 22'

MP 19.2

I-65

CR 1244

VERTICAL CLEARANCE  
NB: 18' 11"  
SB: 17' 8"

EONBK 285+29.89  
EONAHD 284+53.80

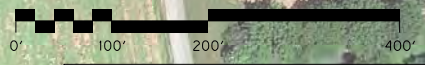

SCALE: 1"=200'

COUNTY OF	ITEM NO.
WARREN	3-20016.00

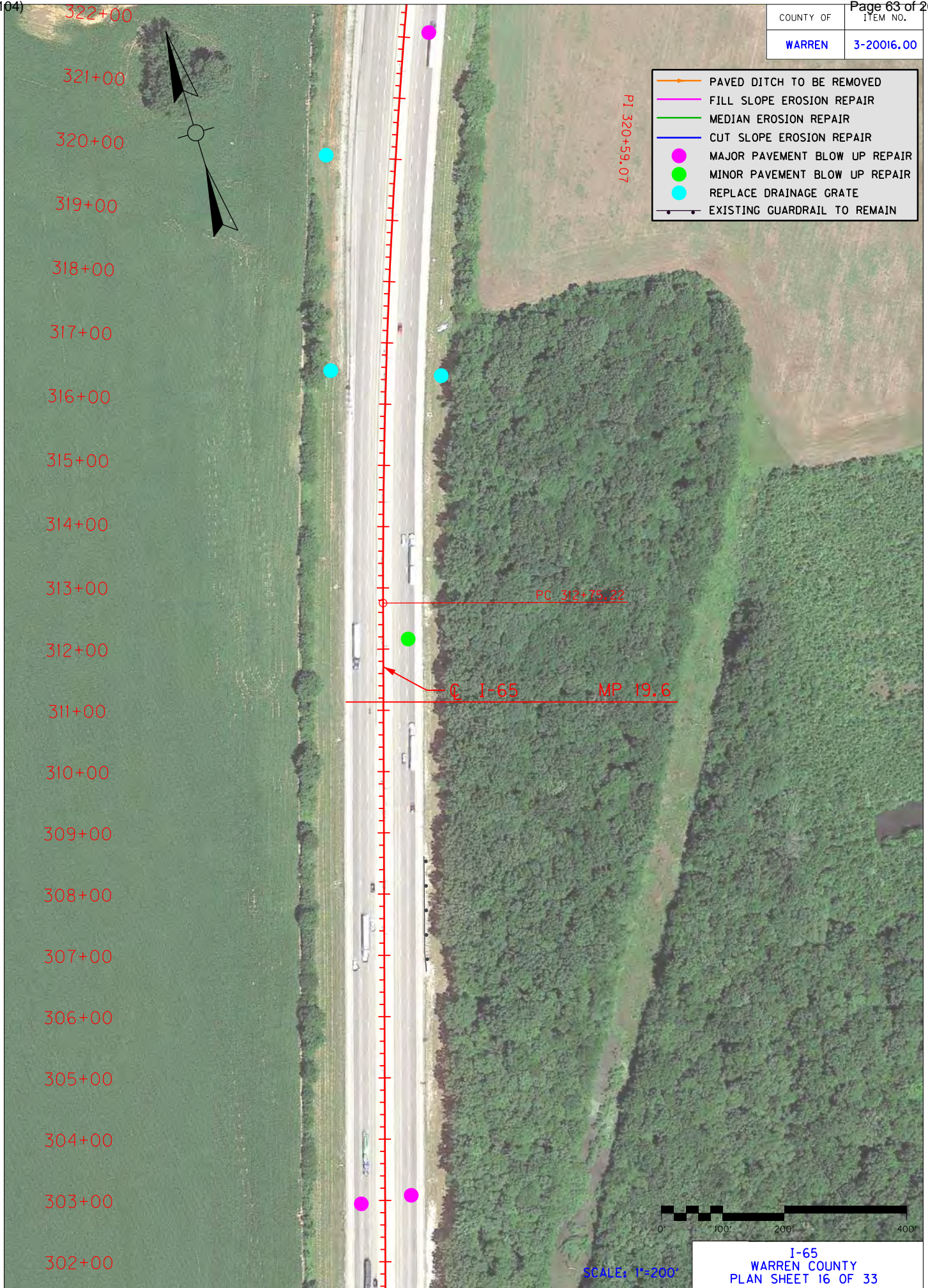

- ▶ PAVED DITCH TO BE REMOVED
- FILL SLOPE EROSION REPAIR
- MEDIAN EROSION REPAIR
- CUT SLOPE EROSION REPAIR
- MAJOR PAVEMENT BLOW UP REPAIR
- MINOR PAVEMENT BLOW UP REPAIR
- REPLACE DRAINAGE GRATE
- EXISTING GUARDRAIL TO REMAIN

PI 320+59.07

PC 312+75.22

C I-65 MP 19.6

322+00

321+00

320+00

319+00

318+00

317+00

316+00

315+00

314+00

313+00

312+00

311+00

310+00

309+00

308+00

307+00

306+00

305+00

304+00

303+00

302+00



SCALE: 1"=200'

I-65  
WARREN COUNTY  
PLAN SHEET 16 OF 33

COUNTY OF	ITEM NO.
WARREN	3-20016.00

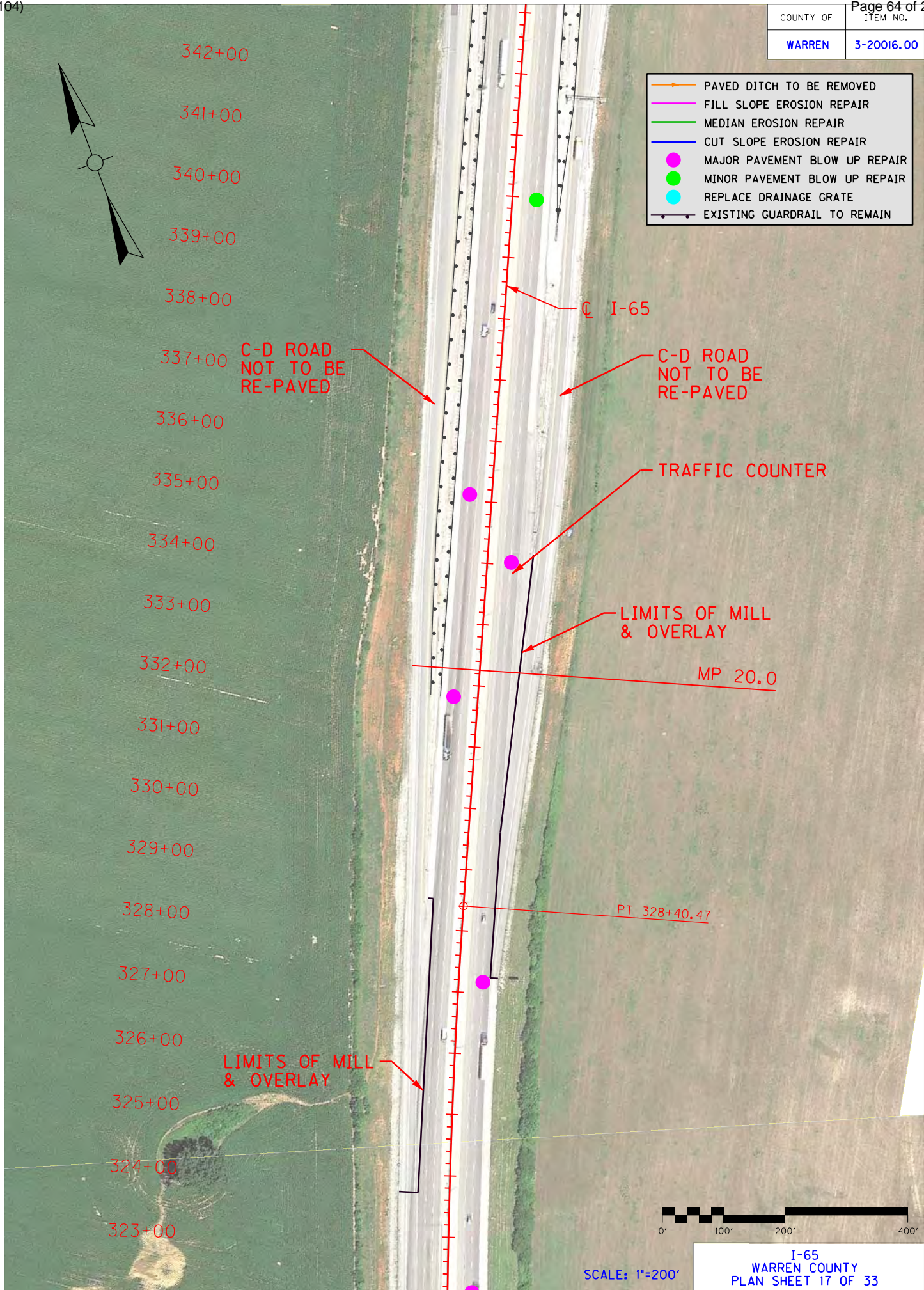

- PAVED DITCH TO BE REMOVED
- FILL SLOPE EROSION REPAIR
- MEDIAN EROSION REPAIR
- CUT SLOPE EROSION REPAIR
- MAJOR PAVEMENT BLOW UP REPAIR
- MINOR PAVEMENT BLOW UP REPAIR
- REPLACE DRAINAGE GRATE
- EXISTING GUARDRAIL TO REMAIN

MP 20.0

PT 328+40.47

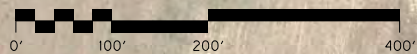

COUNTY OF	ITEM NO.
WARREN	3-20016.00

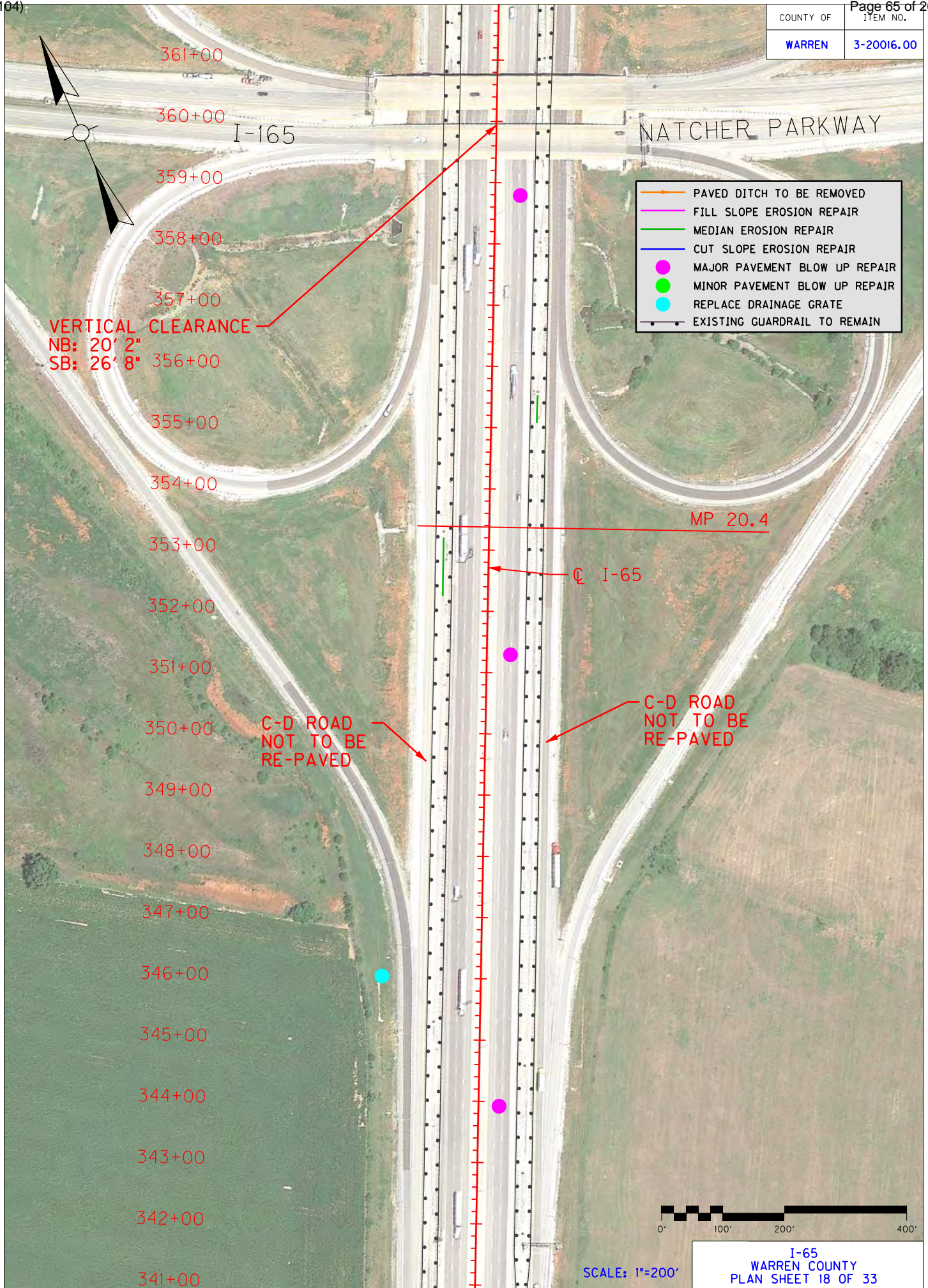

**VERTICAL CLEARANCE**  
 NB: 20' 2"  
 SB: 26' 8"

- PAVED DITCH TO BE REMOVED
- FILL SLOPE EROSION REPAIR
- MEDIAN EROSION REPAIR
- CUT SLOPE EROSION REPAIR
- MAJOR PAVEMENT BLOW UP REPAIR
- MINOR PAVEMENT BLOW UP REPAIR
- REPLACE DRAINAGE GRATE
- EXISTING GUARDRAIL TO REMAIN

C-D ROAD  
 NOT TO BE  
 RE-PAVED

C-D ROAD  
 NOT TO BE  
 RE-PAVED

MP 20.4

☉ I-65

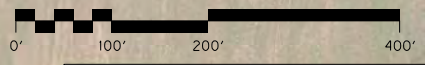

COUNTY OF	ITEM NO.
WARREN	3-20016.00

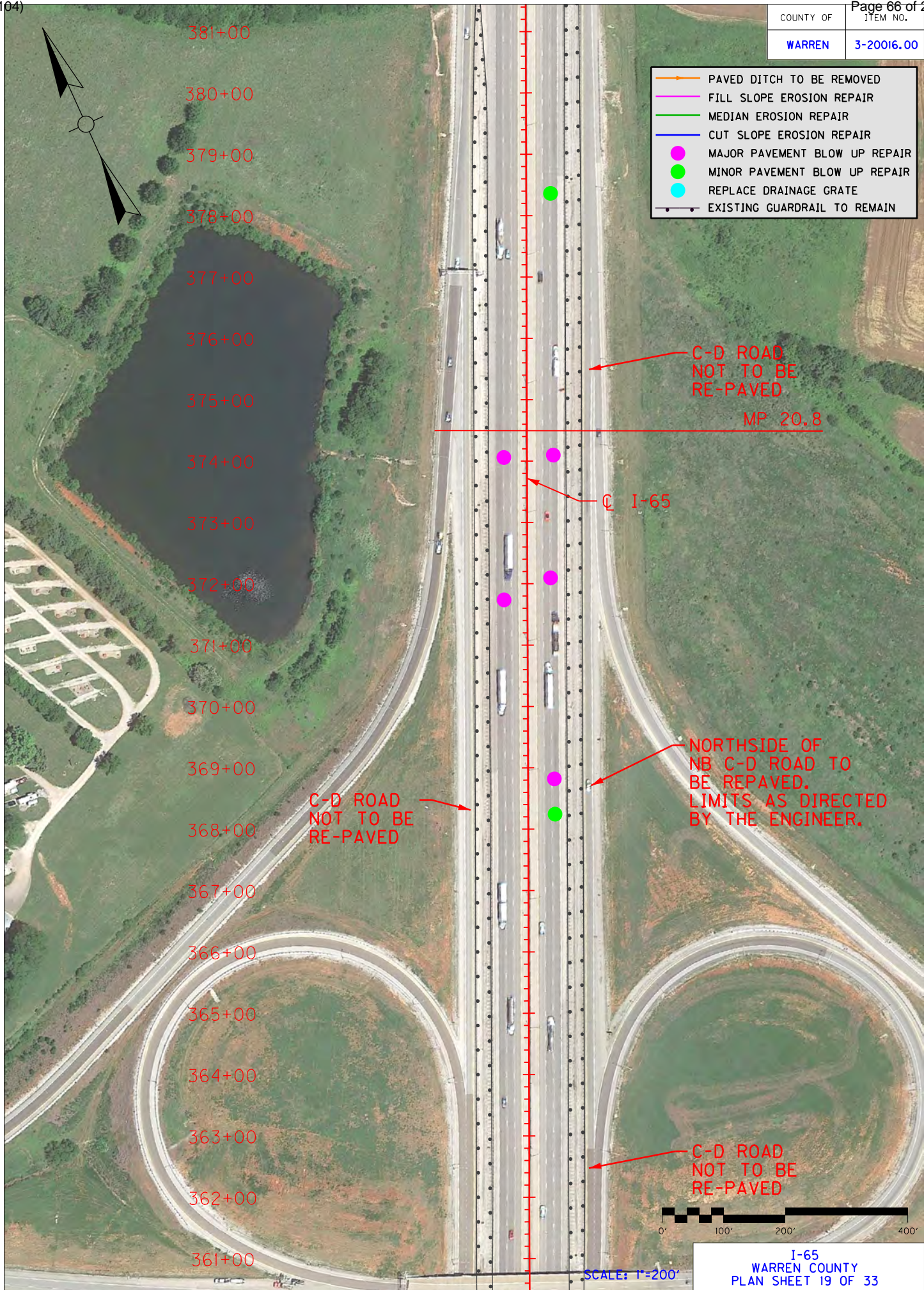

- PAVED DITCH TO BE REMOVED
- FILL SLOPE EROSION REPAIR
- MEDIAN EROSION REPAIR
- CUT SLOPE EROSION REPAIR
- MAJOR PAVEMENT BLOW UP REPAIR
- MINOR PAVEMENT BLOW UP REPAIR
- REPLACE DRAINAGE GRATE
- EXISTING GUARDRAIL TO REMAIN

C-D ROAD  
NOT TO BE  
RE-PAVED

MP 20.8

Q I-65

NORTHSIDE OF  
NB C-D ROAD TO  
BE REPAVED.  
LIMITS AS DIRECTED  
BY THE ENGINEER.

C-D ROAD  
NOT TO BE  
RE-PAVED

C-D ROAD  
NOT TO BE  
RE-PAVED



SCALE: 1"=200'

I-65  
WARREN COUNTY  
PLAN SHEET 19 OF 33

COUNTY OF	ITEM NO.
WARREN	3-20016.00

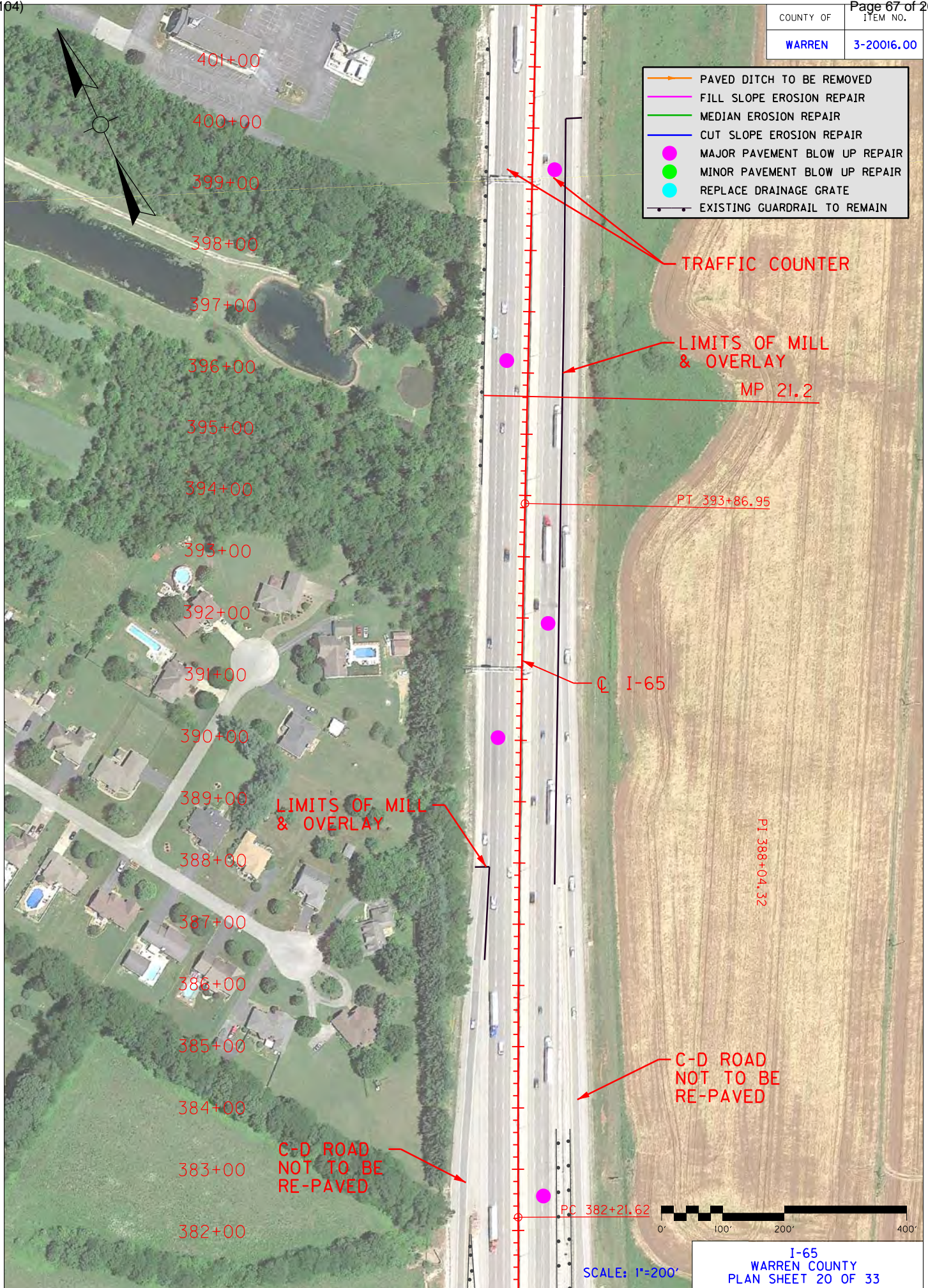

- PAVED DITCH TO BE REMOVED
- FILL SLOPE EROSION REPAIR
- MEDIAN EROSION REPAIR
- CUT SLOPE EROSION REPAIR
- MAJOR PAVEMENT BLOW UP REPAIR
- MINOR PAVEMENT BLOW UP REPAIR
- REPLACE DRAINAGE GRATE
- EXISTING GUARDRAIL TO REMAIN

TRAFFIC COUNTER

LIMITS OF MILL & OVERLAY

MP 21.2

PT 393+86.95

Q I-65

LIMITS OF MILL & OVERLAY

PI 388+04.32

C-D ROAD NOT TO BE RE-PAVED

C-D ROAD NOT TO BE RE-PAVED

PC 382+21.62

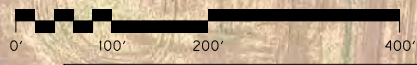

SCALE: 1"=200'

I-65  
WARREN COUNTY  
PLAN SHEET 20 OF 33

COUNTY OF	ITEM NO.
WARREN	3-20016.00

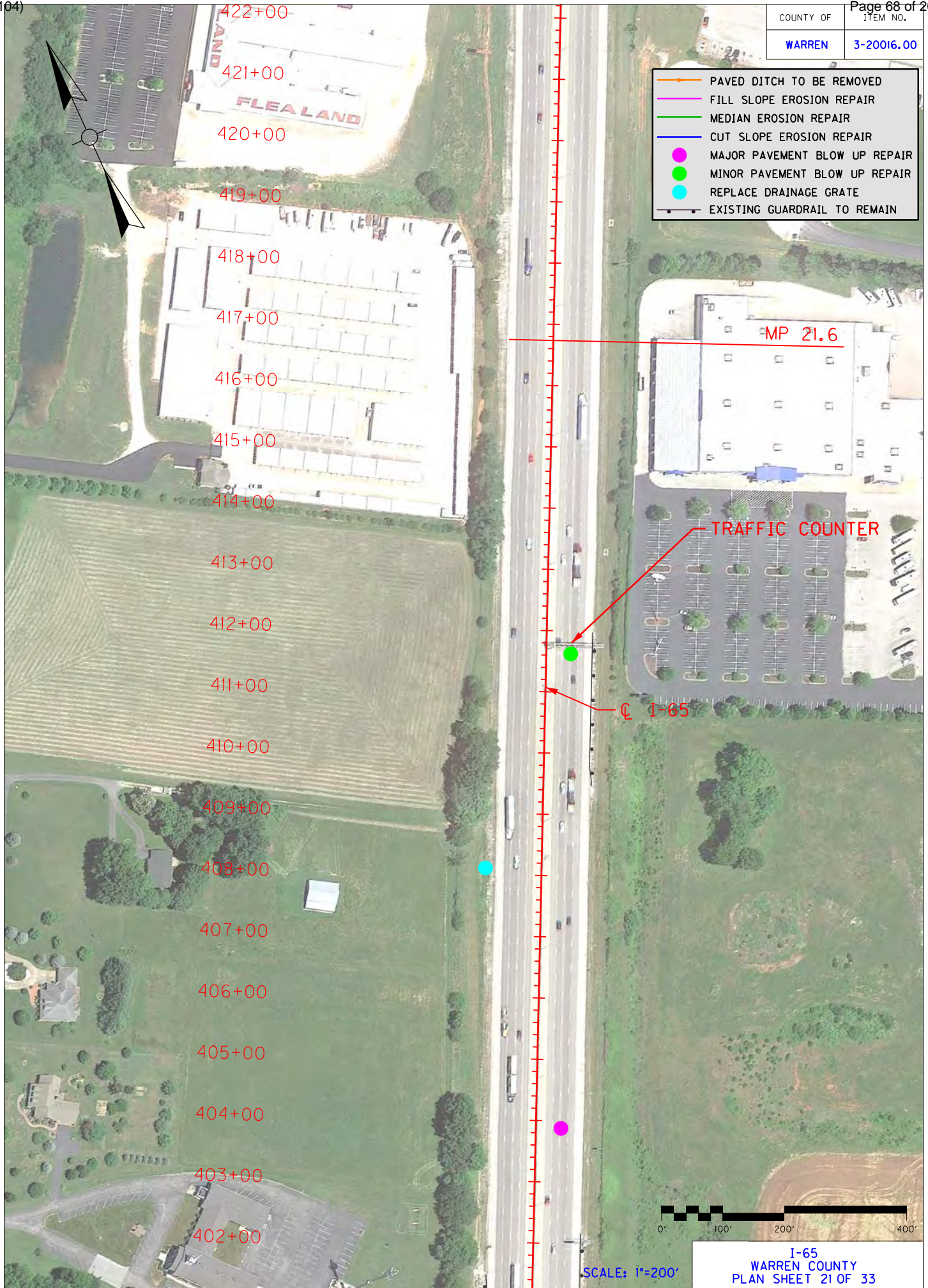

- PAVED DITCH TO BE REMOVED
- FILL SLOPE EROSION REPAIR
- MEDIAN EROSION REPAIR
- CUT SLOPE EROSION REPAIR
- MAJOR PAVEMENT BLOW UP REPAIR
- MINOR PAVEMENT BLOW UP REPAIR
- REPLACE DRAINAGE GRATE
- EXISTING GUARDRAIL TO REMAIN

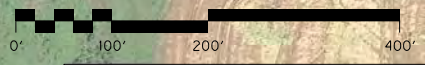

SCALE: 1"=200'  
I-65  
WARREN COUNTY  
PLAN SHEET 21 OF 33

COUNTY OF	ITEM NO.
WARREN	3-20016.00

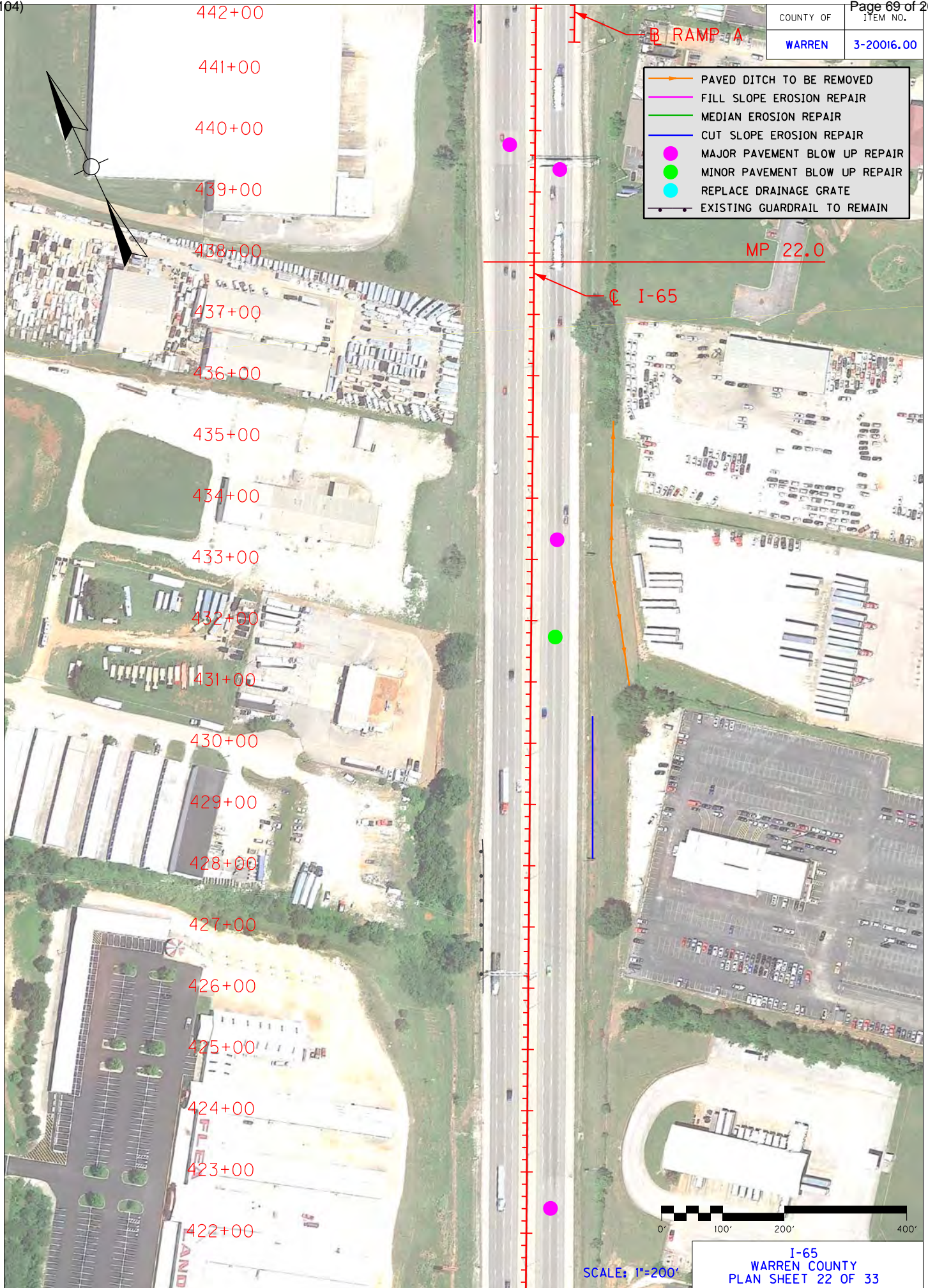

442+00  
441+00  
440+00  
439+00  
438+00  
437+00  
436+00  
435+00  
434+00  
433+00  
432+00  
431+00  
430+00  
429+00  
428+00  
427+00  
426+00  
425+00  
424+00  
423+00  
422+00

- PAVED DITCH TO BE REMOVED
- FILL SLOPE EROSION REPAIR
- MEDIAN EROSION REPAIR
- CUT SLOPE EROSION REPAIR
- MAJOR PAVEMENT BLOW UP REPAIR
- MINOR PAVEMENT BLOW UP REPAIR
- REPLACE DRAINAGE GRATE
- EXISTING GUARDRAIL TO REMAIN



I-65  
WARREN COUNTY  
PLAN SHEET 22 OF 33  
SCALE: 1"=200'

COUNTY OF	ITEM NO.
WARREN	3-20016.00

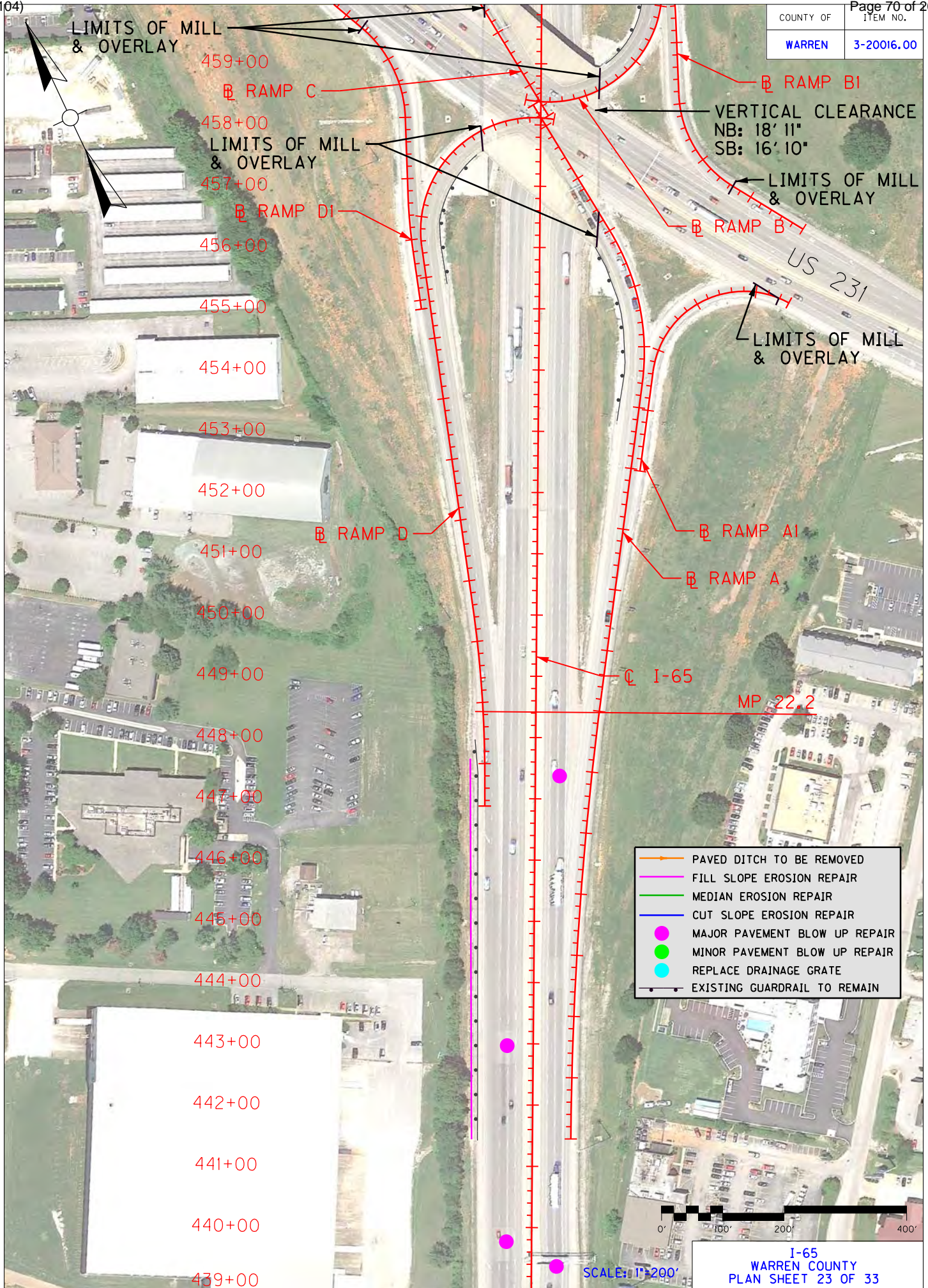

459+00  
 458+00  
 457+00  
 456+00  
 455+00  
 454+00  
 453+00  
 452+00  
 451+00  
 450+00  
 449+00  
 448+00  
 447+00  
 446+00  
 445+00  
 444+00  
 443+00  
 442+00  
 441+00  
 440+00  
 439+00

LIMITS OF MILL & OVERLAY

RAMP C

LIMITS OF MILL & OVERLAY

RAMP DI

RAMP D

VERTICAL CLEARANCE  
NB: 18' 11"  
SB: 16' 10"

LIMITS OF MILL & OVERLAY

RAMP B

US 231

LIMITS OF MILL & OVERLAY

RAMP AI

RAMP A

I-65









MP 22.2

- PAVED DITCH TO BE REMOVED
- FILL SLOPE EROSION REPAIR
- MEDIAN EROSION REPAIR
- CUT SLOPE EROSION REPAIR
- MAJOR PAVEMENT BLOW UP REPAIR
- MINOR PAVEMENT BLOW UP REPAIR
- REPLACE DRAINAGE GRATE
- EXISTING GUARDRAIL TO REMAIN



I-65  
 WARREN COUNTY  
 PLAN SHEET 23 OF 33  
 SCALE: 1"=200'

COUNTY OF	ITEM NO.
WARREN	3-20016.00

-  PAVED DITCH TO BE REMOVED
-  FILL SLOPE EROSION REPAIR
-  MEDIAN EROSION REPAIR
-  CUT SLOPE EROSION REPAIR
-  MAJOR PAVEMENT BLOW UP REPAIR
-  MINOR PAVEMENT BLOW UP REPAIR
-  REPLACE DRAINAGE GRATE
-  EXISTING GUARDRAIL TO REMAIN

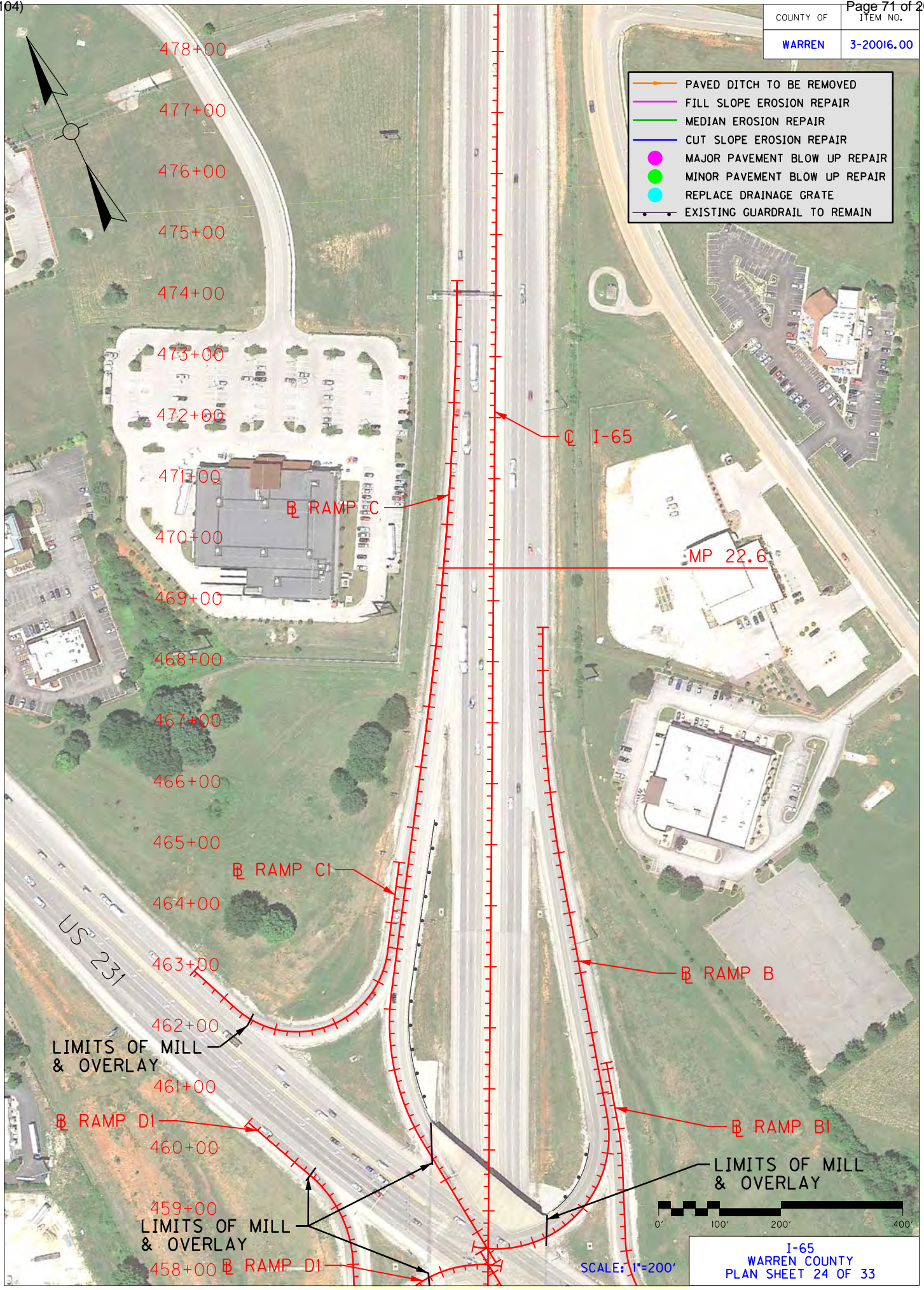

LIMITS OF MILL & OVERLAY

LIMITS OF MILL & OVERLAY

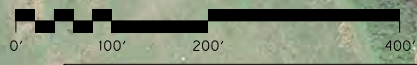

SCALE: 1"=200'

I-65  
WARREN COUNTY  
PLAN SHEET 24 OF 33

COUNTY OF	ITEM NO.
WARREN	3-20016.00

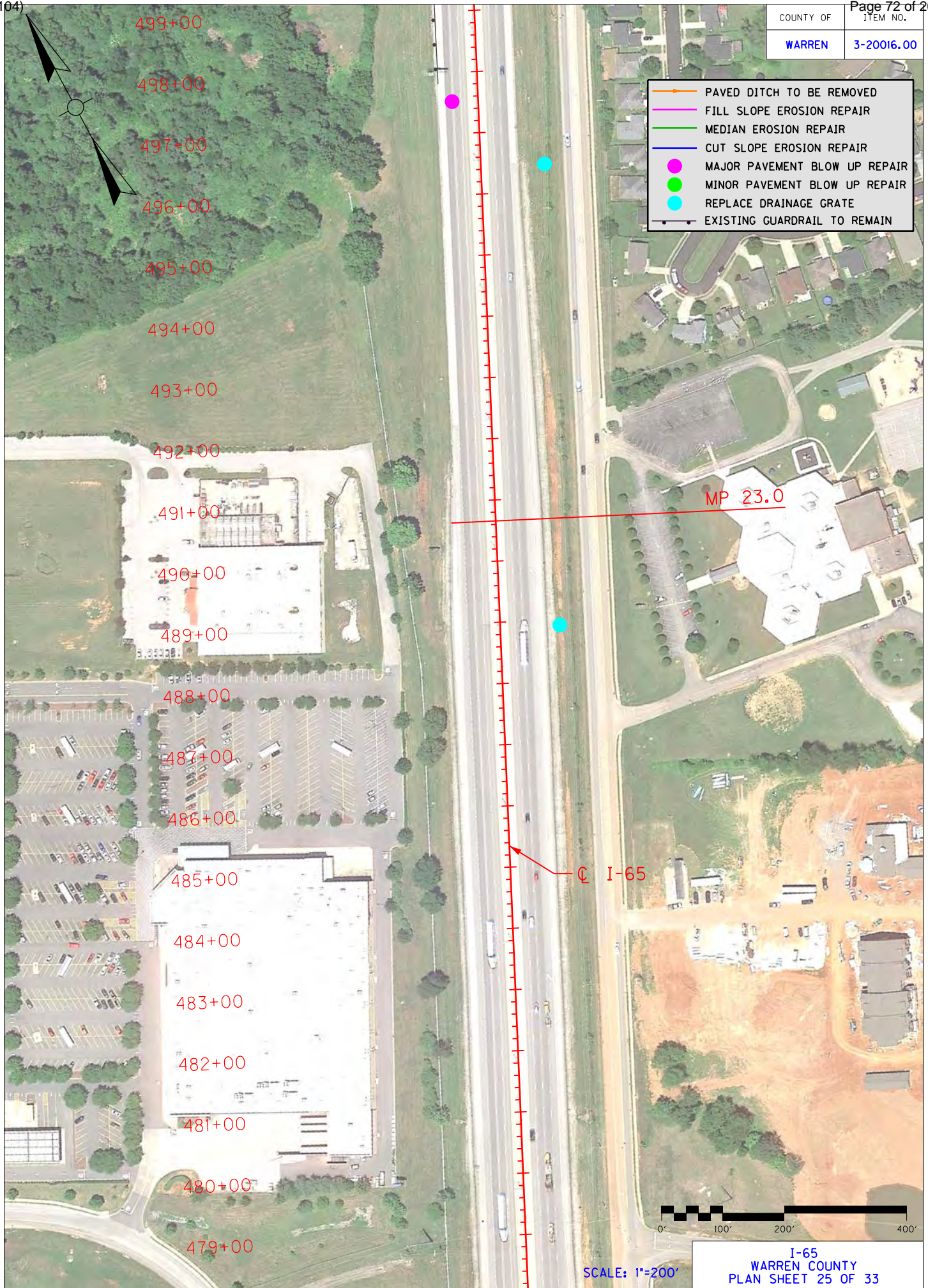

- PAVED DITCH TO BE REMOVED
- FILL SLOPE EROSION REPAIR
- MEDIAN EROSION REPAIR
- CUT SLOPE EROSION REPAIR
- MAJOR PAVEMENT BLOW UP REPAIR
- MINOR PAVEMENT BLOW UP REPAIR
- REPLACE DRAINAGE GRATE
- EXISTING GUARDRAIL TO REMAIN





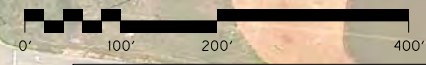

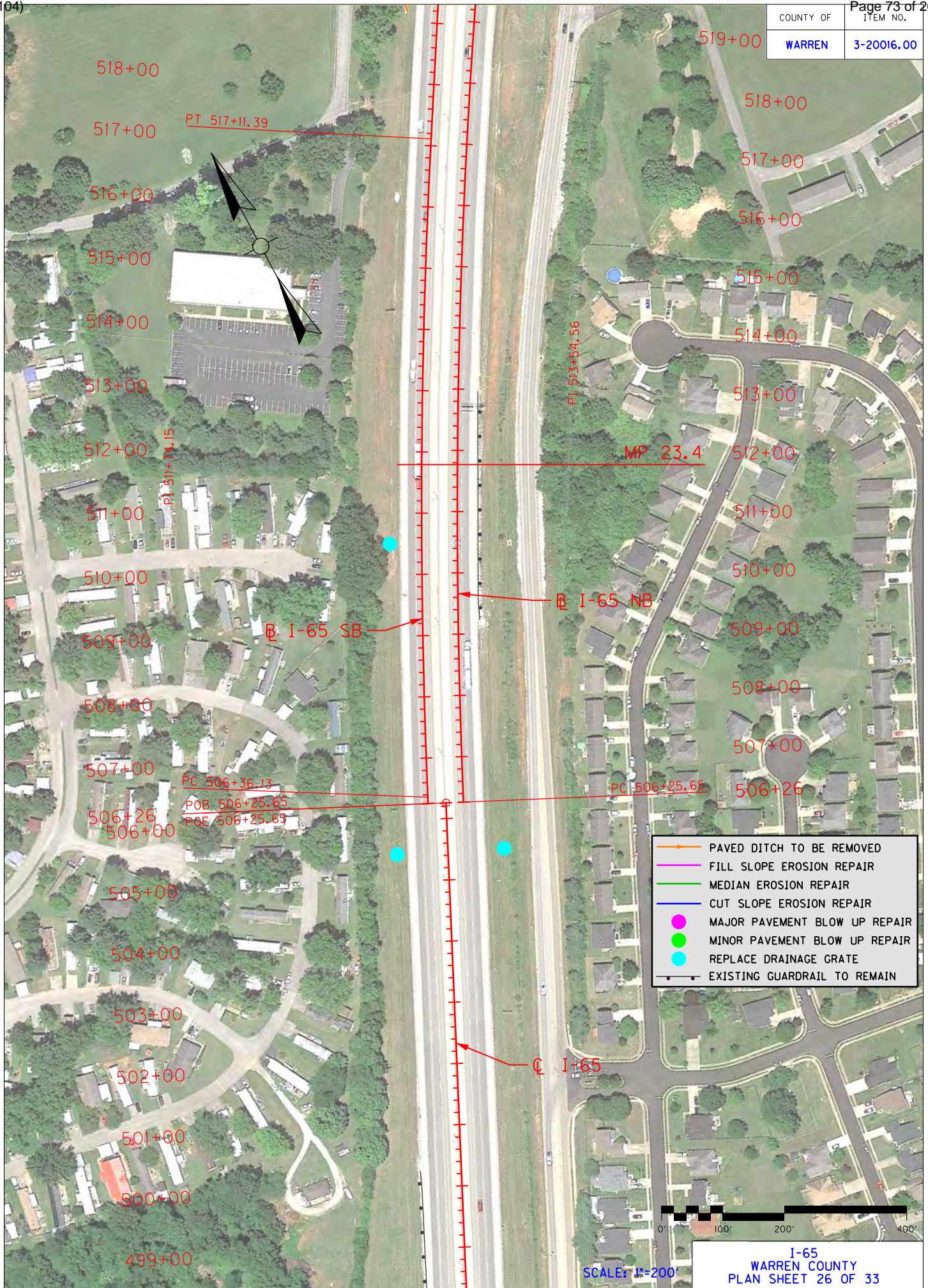

MP 23.0

I-65



COUNTY OF	ITEM NO.
WARREN	3-20016.00



-  PAVED DITCH TO BE REMOVED
-  FILL SLOPE EROSION REPAIR
-  MEDIAN EROSION REPAIR
-  CUT SLOPE EROSION REPAIR
-  MAJOR PAVEMENT BLOW UP REPAIR
-  MINOR PAVEMENT BLOW UP REPAIR
-  REPLACE DRAINAGE GRATE
-  EXISTING GUARDRAIL TO REMAIN

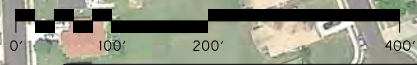

I-65  
WARREN COUNTY  
PLAN SHEET 26 OF 33  
SCALE: 1"=200'

COUNTY OF	ITEM NO.
WARREN	3-20016.00

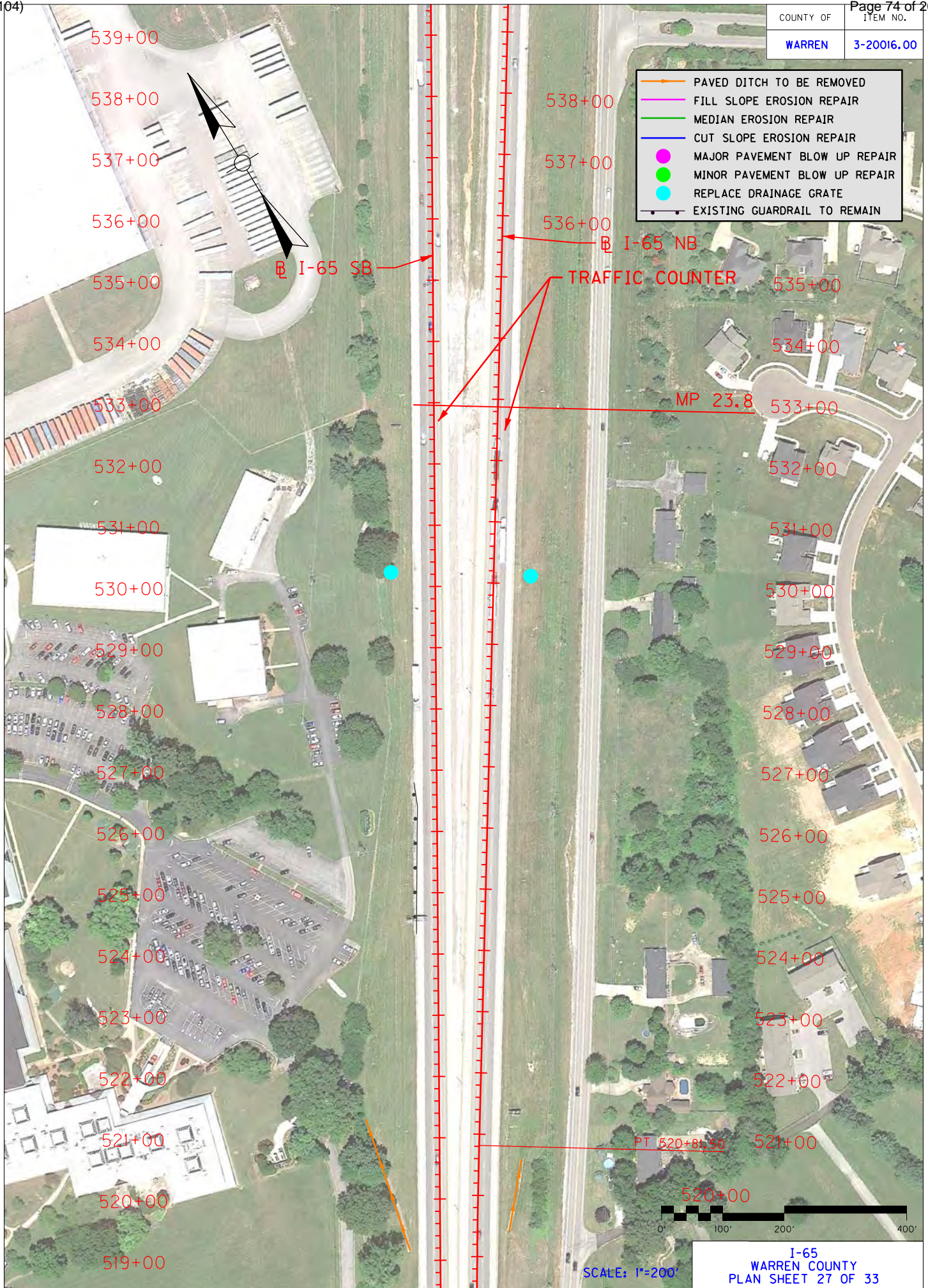

- PAVED DITCH TO BE REMOVED
- FILL SLOPE EROSION REPAIR
- MEDIAN EROSION REPAIR
- CUT SLOPE EROSION REPAIR
- MAJOR PAVEMENT BLOW UP REPAIR
- MINOR PAVEMENT BLOW UP REPAIR
- REPLACE DRAINAGE GRATE
- EXISTING GUARDRAIL TO REMAIN

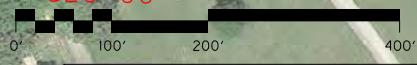

COUNTY OF	ITEM NO.
WARREN	3-20016.00

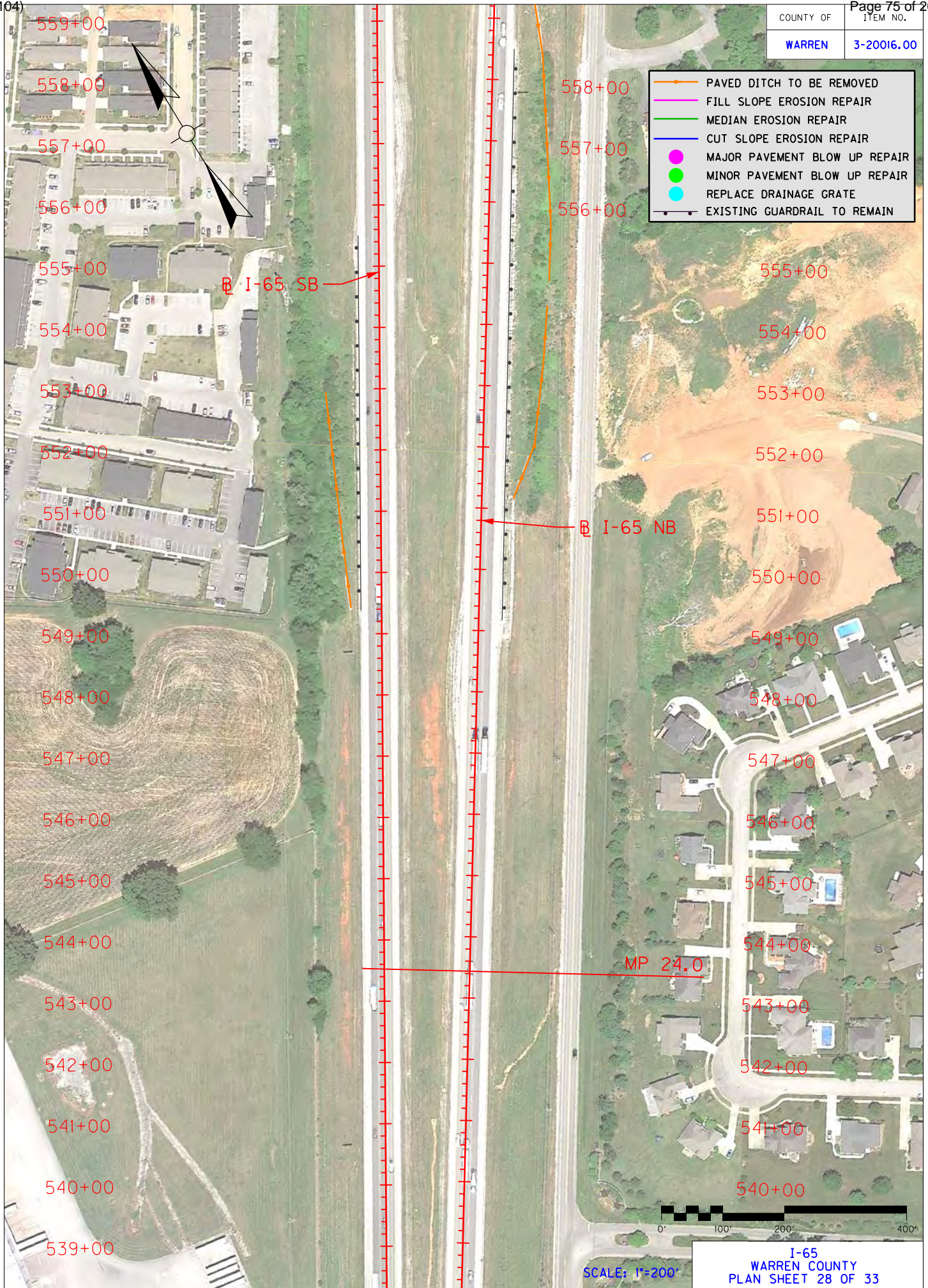

COUNTY OF	ITEM NO.
WARREN	3-20016.00

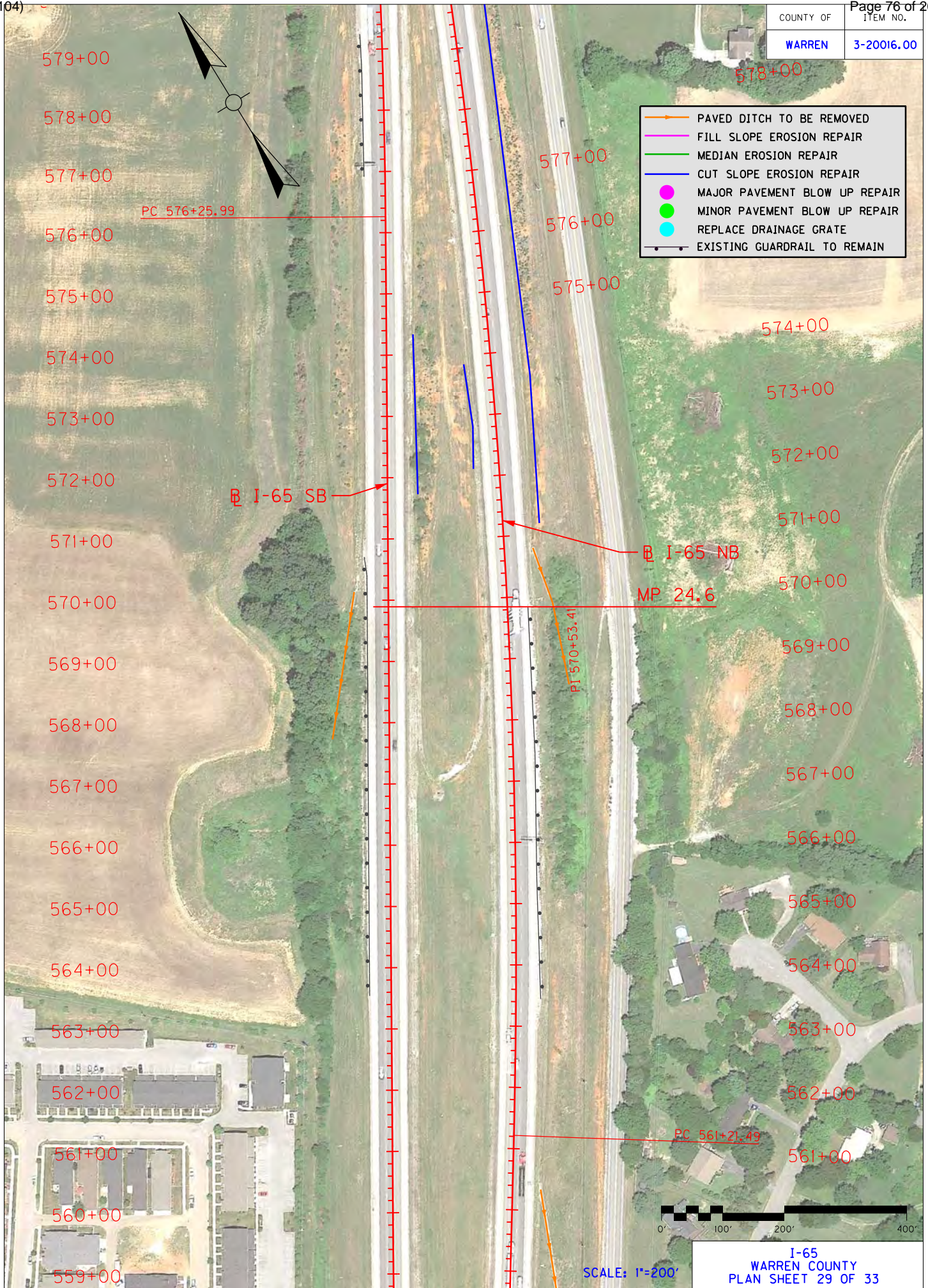

- PAVED DITCH TO BE REMOVED
- FILL SLOPE EROSION REPAIR
- MEDIAN EROSION REPAIR
- CUT SLOPE EROSION REPAIR
- MAJOR PAVEMENT BLOW UP REPAIR
- MINOR PAVEMENT BLOW UP REPAIR
- REPLACE DRAINAGE GRATE
- EXISTING GUARDRAIL TO REMAIN

PC 576+25.99

B I-65 SB

B I-65 NB

MP 24.6

PI 570+53.41

PC 561+21.49



I-65  
WARREN COUNTY  
PLAN SHEET 29 OF 33

COUNTY OF	ITEM NO.
WARREN	3-20016.00

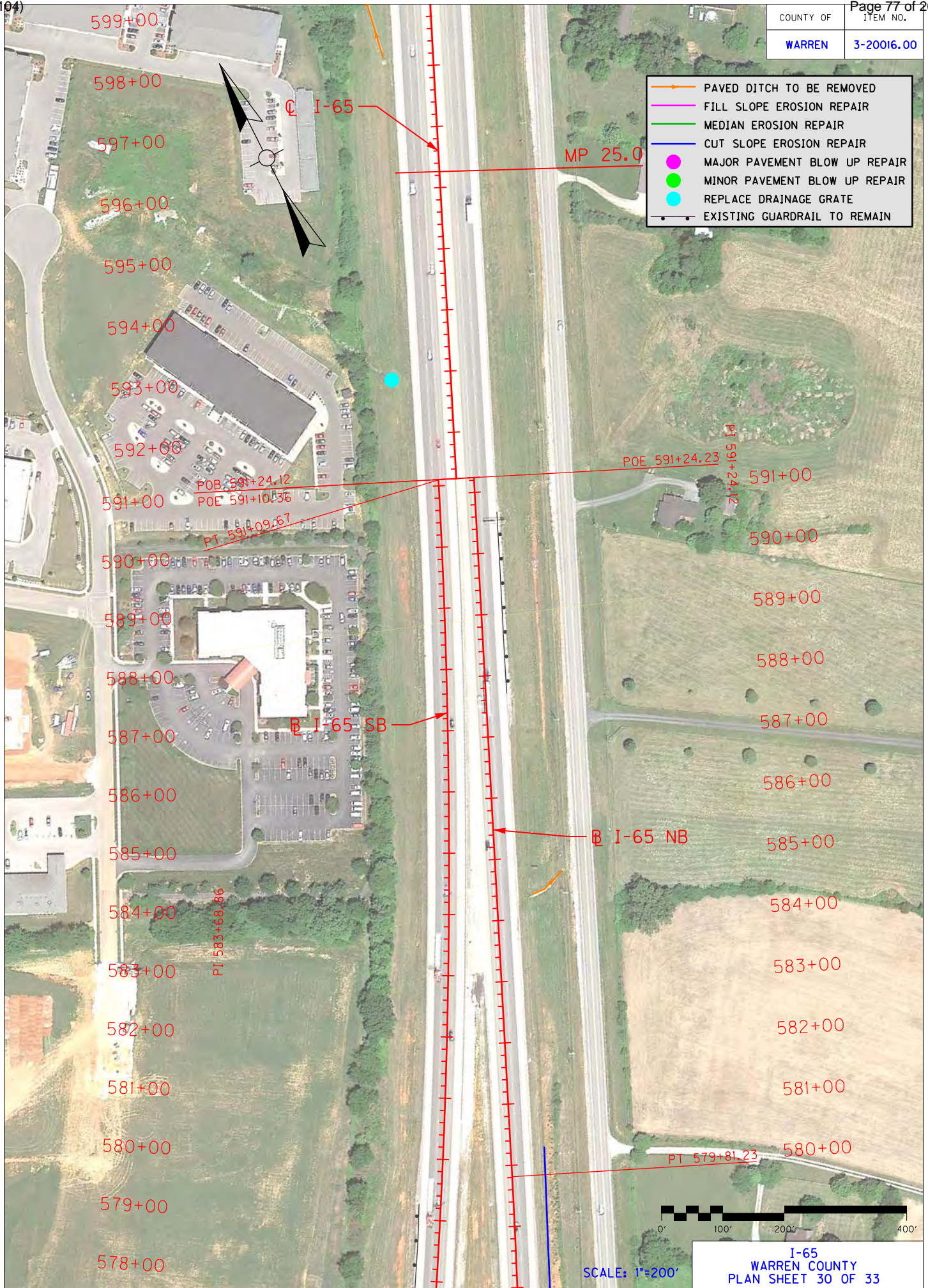

- PAVED DITCH TO BE REMOVED
- FILL SLOPE EROSION REPAIR
- MEDIAN EROSION REPAIR
- CUT SLOPE EROSION REPAIR
- MAJOR PAVEMENT BLOW UP REPAIR
- MINOR PAVEMENT BLOW UP REPAIR
- REPLACE DRAINAGE GRATE
- EXISTING GUARDRAIL TO REMAIN



SCALE: 1"=200'  
**I-65**  
**WARREN COUNTY**  
**PLAN SHEET 30 OF 33**

COUNTY OF	ITEM NO.
WARREN	3-20016.00

- PAVED DITCH TO BE REMOVED
- FILL SLOPE EROSION REPAIR
- MEDIAN EROSION REPAIR
- CUT SLOPE EROSION REPAIR
- MAJOR PAVEMENT BLOW UP REPAIR
- MINOR PAVEMENT BLOW UP REPAIR
- REPLACE DRAINAGE GRATE
- EXISTING GUARDRAIL TO REMAIN

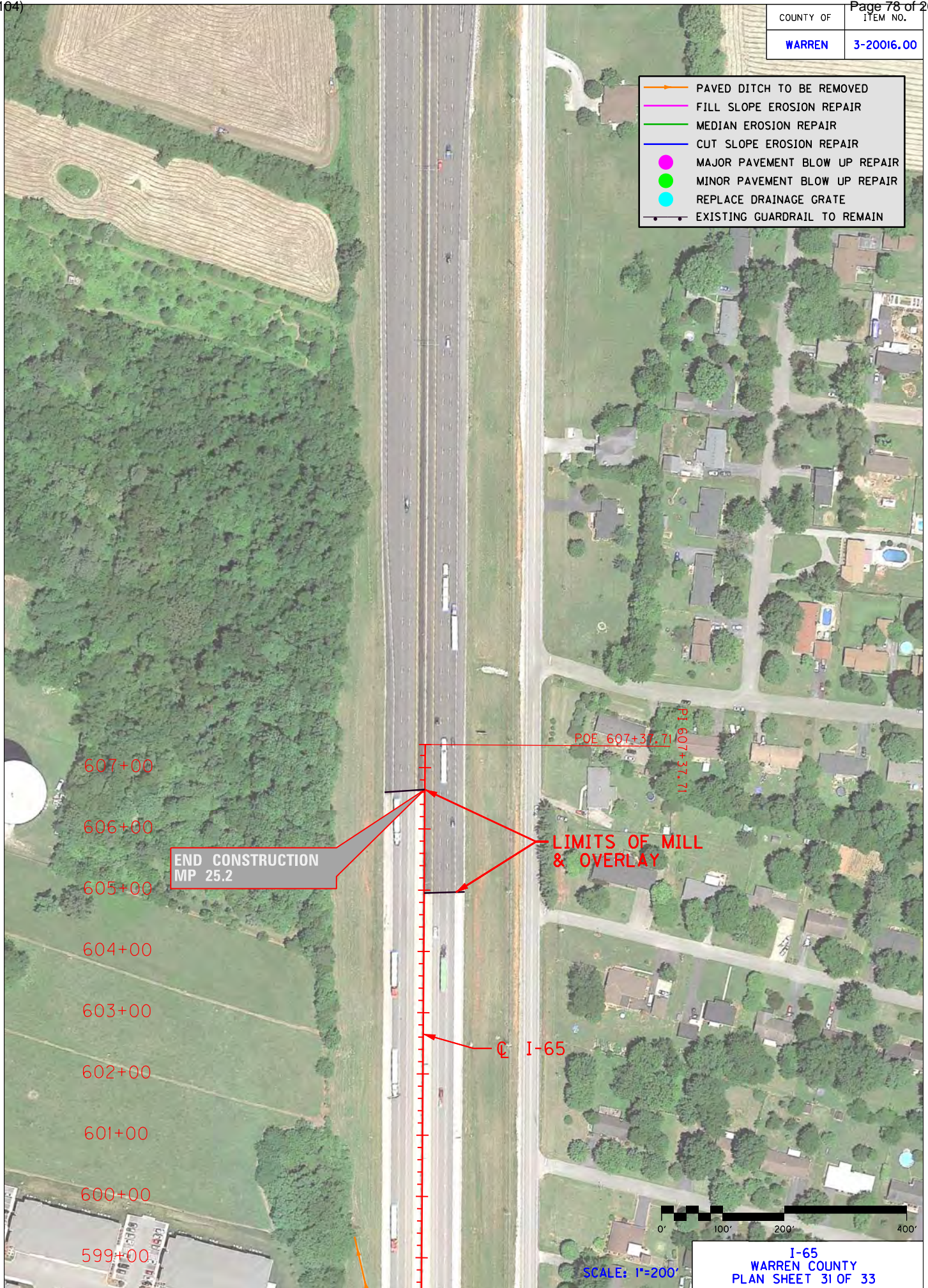

END CONSTRUCTION  
MP 25.2

LIMITS OF MILL  
& OVERLAY

POE 607+37.71

Pi 607+37.71

Q I-65



I-65  
WARREN COUNTY  
PLAN SHEET 31 OF 33

COUNTY OF	ITEM NO.
WARREN	3-20016.00

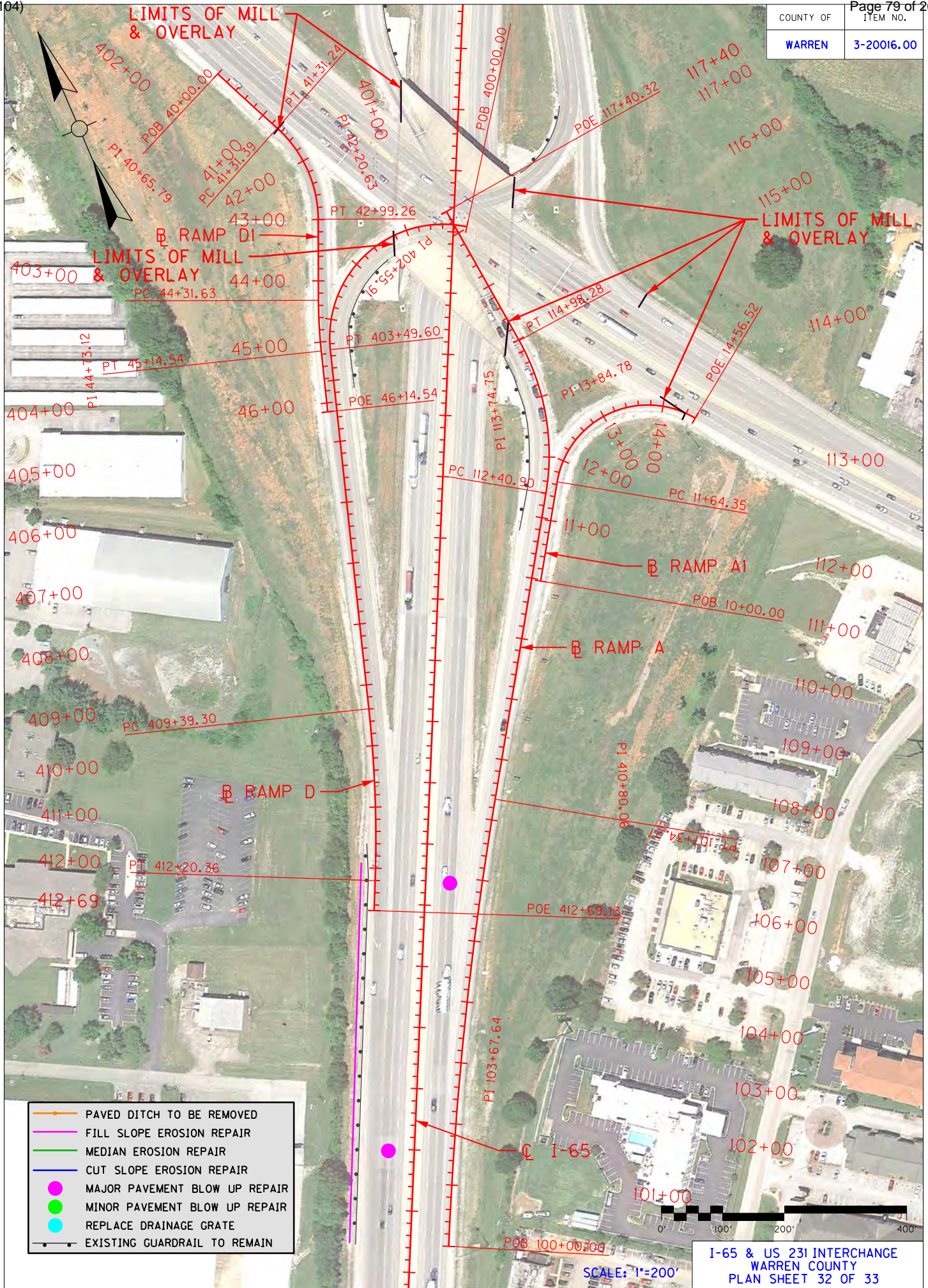



- PAVED DITCH TO BE REMOVED
- FILL SLOPE EROSION REPAIR
- MEDIAN EROSION REPAIR
- CUT SLOPE EROSION REPAIR
- MAJOR PAVEMENT BLOW UP REPAIR
- MINOR PAVEMENT BLOW UP REPAIR
- REPLACE DRAINAGE GRATE
- EXISTING GUARDRAIL TO REMAIN

I-65 & US 231 INTERCHANGE  
WARREN COUNTY  
PLAN SHEET 32 OF 33

SCALE: 1"=200'

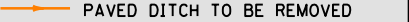
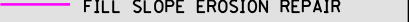
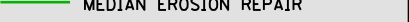
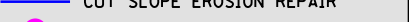
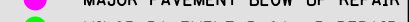
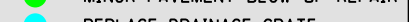
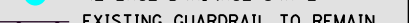
COUNTY OF	ITEM NO.
WARREN	3-20016.00

-  PAVED DITCH TO BE REMOVED
-  FILL SLOPE EROSION REPAIR
-  MEDIAN EROSION REPAIR
-  CUT SLOPE EROSION REPAIR
-  MAJOR PAVEMENT BLOW UP REPAIR
-  MINOR PAVEMENT BLOW UP REPAIR
-  REPLACE DRAINAGE GRATE
-  EXISTING GUARDRAIL TO REMAIN

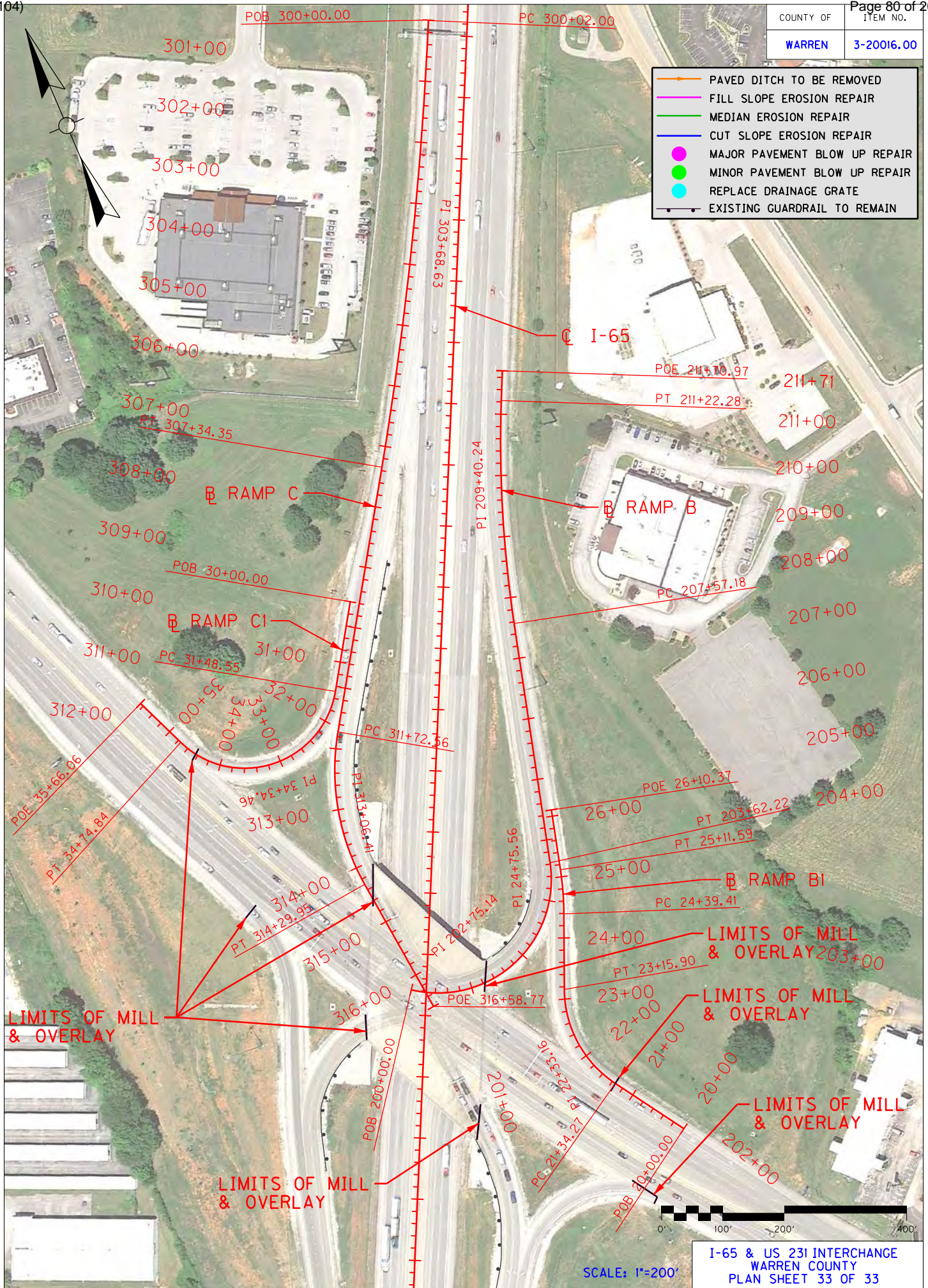

I-65 & US 231 INTERCHANGE  
WARREN COUNTY  
PLAN SHEET 33 OF 33

COUNTY OF	ITEM NO.
WARREN	3-20016.00

# MAJOR BLOW UP PAVEMENT REPAIR DETAIL

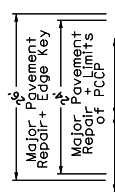

Widths are Abbreviated, Actual Widths are as Directed by the Engineer.

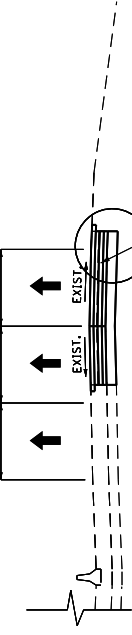

## CROSS SECTION

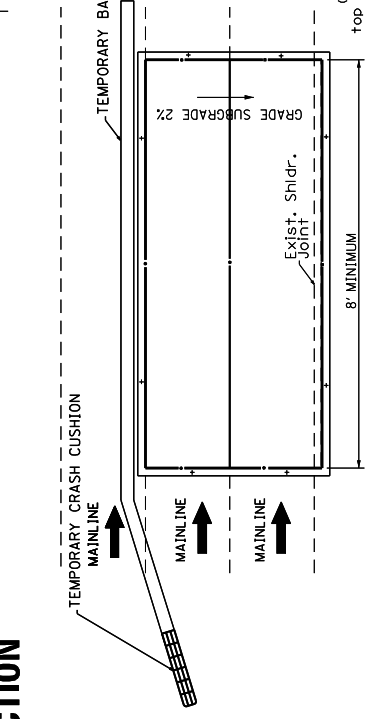

## PLAN VIEW

## PROFILE

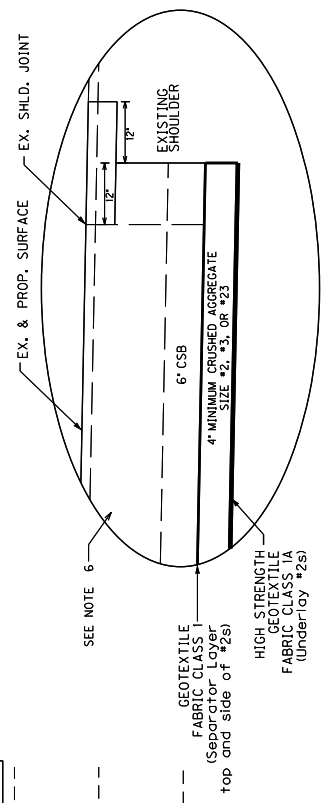

## DETAIL A

## NOTES

1. Caution: Existing solid concrete pavement may exist below the asphalt pavement. This shall be saw cut for removal.
2. Repairs shall be performed at locations selected by and as directed by the Engineer. The Engineer will assess, select, and mark areas for treatment. The full lane width will be removed and replaced. The Engineer may elect to perform repairs on one lane or multiple lanes. An edge key 12" into existing pavement is required for the top course of base, if only one lane is being repaired, carry top base course 12" into adjacent lane when MOT allows.
3. Complete major pavement repair operations in one continuous operation and protect with barrier wall. Do not leave an unprotected hole with no workers present.
4. Length of required barrier wall estimated to be 200 feet per Major Blow Up Pavement Repair location. Actual length to be as directed by The Engineer.
5. Perform typical mill and inlay operations with resurfacing items subject to payment as part of the resurfacing operation.
6. Asphalt base courses to be 4" thick as directed by Engineer and shall be CL4 ASPH BASE 1,000 PG76-22. Existing asphalt depth varies. See Existing Typical Sections.

## QUANTITIES TO BID

- 02003 RELOCATE TEMP CONC BARRIER
  - 02898 RELOCATE CRASH CUSHION
  - 03171 CONCRETE BARRIER WALL TYPE 9T
  - 03240 BASE FAILURE REPAIR
  - \* 08903 CRASH CUSHION 11 VI CLASS BT TL3
- LF EACH  
LF EACH  
SQ. YD.  
EA. CH

• The bid item BASE FAILURE REPAIR shall include all materials and work to complete the Major Blow Up Pavement Repair as directed by the Engineer. This includes saw cuts of pavement, removal of pavement, edge keys, asphalt base courses, crushed stone base, crushed graded aggregate size #57s, crushed graded aggregate (size #2, #3, or #23), Class 1 and Class 1A geotextile fabric.

NOT TO SCALE

MAJOR BLOW UP REPAIR DETAIL

# MINOR (BLOW UP) PAVEMENT REPAIR DETAIL

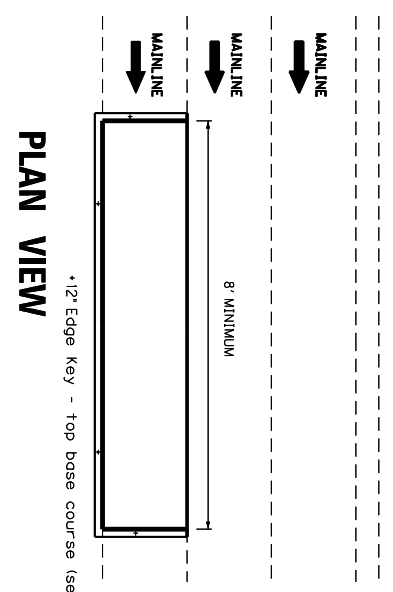
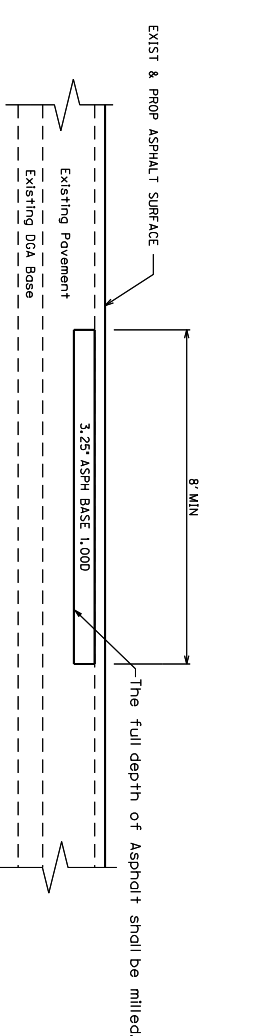
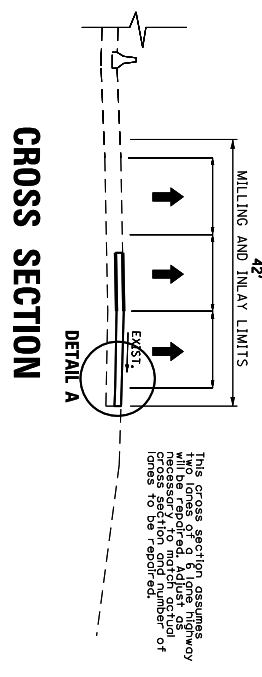

**NOTES**

1. Cautions: Existing solid concrete pavement may exist below the asphalt pavement. This shall be sawcut for removal.
2. Pavement repairs shall be performed at locations selected by and as directed by the Engineer. The Engineer will assess, select, and mark areas for treatment. The full lane width will be removed and replaced. The Engineer may elect to perform repairs on one lane or multiple lanes. The Engineer may elect to only remove and replace the top lift of base or may decide a Base Failure Repair is more appropriate (see Base Failure Repair Detail). An edge key 1/2" into existing pavement is required for the top course of base.
3. Complete pavement repair operations in one continuous operation or protect with barrier wall. Do not leave an unprotected hole with no workers present. If barrier wall must be used for pavement repairs, it will be considered incidental to other items of work and not be considered for payment.
4. Before resurfacing, open repaired area to traffic for a minimum of 14 days. Monitor pavement for settlement during this 14 days and repair by leveling and wedging, as approved by the Engineer, until placement of final surface course.
5. Do not install edge key unless directed by the Engineer.
6. Perform typical mill and inlay operations with resurfacing items subject to payment as part of the resurfacing operation.
7. Asphalt base courses shall be CL4 ASPH BASE PCT6-22 1,000.

**DETAIL A**

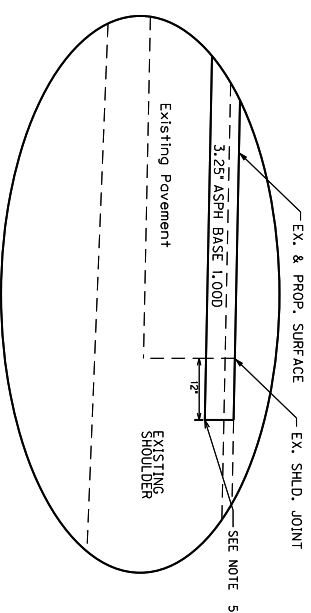

**\*QUANTITIES TO BID**  
20757ED PAVEMENT REPAIR SQ. YD.  
\* The Bid Item 20757ED PAVEMENT REPAIR shall include all materials and work to complete the repair as directed by the Engineer. This includes saw cuts of pavement, removal of pavement, and asphalt courses.

**NOT TO SCALE** **MINOR (BLOW UP) PAVEMENT REPAIR DETAIL**

COUNTY OF	ITEM NO.
<b>WARREN</b>	<b>3-20016.00</b>

COUNTY OF	ITEM NO.
WARREN	3-20016.00

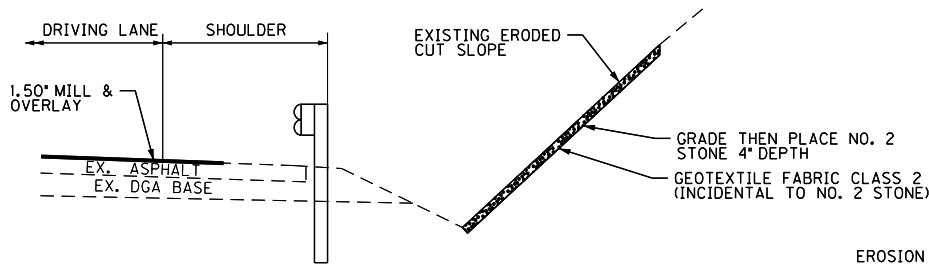

**CUT SLOPE EROSION REPAIR**

NOT TO SCALE

QUANTITIES TO BID

00078 CRUSHED AGGREGATE NO 2 TON

EROSION REPAIR NOTES

- 1 GRADING THE SLOPE PRIOR TO PLACEMENT OF NO. 2 STONE WILL BE INCIDENTAL TO THE STONE BID ITEM.
- 2 A QUANTITY OF CHANNEL LINING CLASS II HAS BEEN INCLUDED ON THE GENERAL SUMMARY FOR FILLING IN DEEPLY ERODED AREAS PRIOR TO GRADING AND PLACING THE NO. 2 STONE.

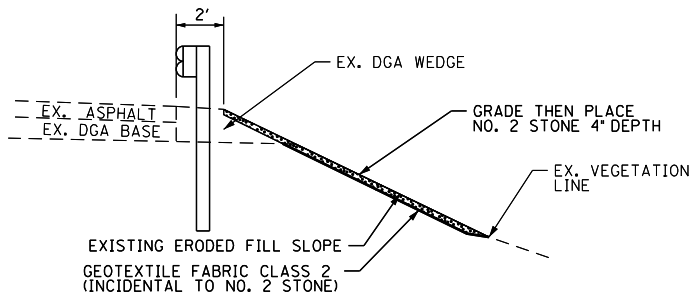

**SHOULDER AND FILL SLOPE REPAIR**

NOT TO SCALE

QUANTITIES TO BID

00078 CRUSHED AGGREGATE NO 2 TON  
02483 CHANNEL LINING CLASS II TON

SHOULDER AND FILL SLOPE REPAIR NOTES

- 1 GRADING THE SLOPE PRIOR TO PLACEMENT OF NO. 2 STONE WILL BE INCIDENTAL TO THE STONE BID ITEM.
- 2 A QUANTITY OF CHANNEL LINING CLASS II HAS BEEN INCLUDED ON THE GENERAL SUMMARY FOR FILLING IN DEEPLY ERODED AREAS PRIOR TO GRADING AND PLACING THE NO. 2 STONE.

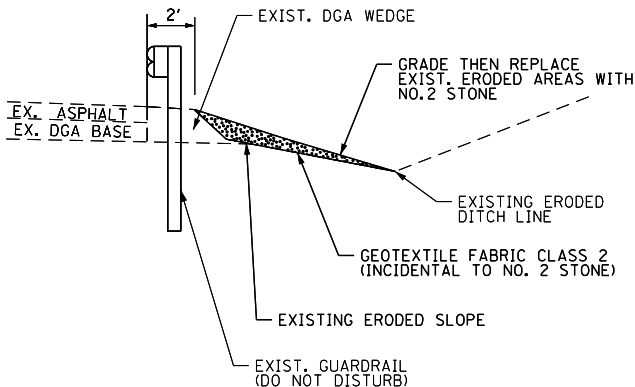

MEDIAN EROSION REPAIR NOTES

- 1 GRADING THE SLOPE PRIOR TO PLACEMENT OF NO. 2 STONE WILL BE INCIDENTAL TO NO. 2 STONE BID ITEM.
- 2 A QUANTITY OF CHANNEL LINING CLASS II HAS BEEN INCLUDED ON THE GENERAL SUMMARY FOR FILLING IN DEEPLY ERODED AREAS PRIOR TO GRADING AND PLACING CHANNEL LINING CLASS II.
- 3 MEDIAN EROSION REPAIR FOR USE AT THE MEDIAN BETWEEN I-65 AND THE C-D ROAD FOR THE I-165 INTERCHANGE.

**MEDIAN EROSION REPAIR**

NOT TO SCALE

QUANTITIES TO BID

00078 CRUSHED AGGREGATE NO 2 TON  
02483 CHANNEL LINING CLASS II TON

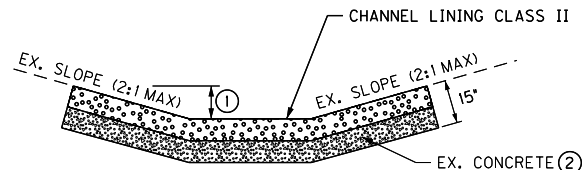

**PAVED DITCH REPAIR**

NOT TO SCALE

PAVED DITCH REPAIR NOTES

- ① MATCH EXISTING DEPTH OR 1.0' MIN. WHICHEVER IS GREATER.
- ② EXISTING CONCRETE TO BE BROKEN INTO PIECES THE SIZE OF THE SPECIFIED CHANNEL LINING AND RESHAPED TO THAT OF THE NEW DITCH. SHALL BE PAID FOR BY 'REMOVE PAVED DITCH' BID ITEM.

QUANTITIES TO BID

02165 REMOVE PAVED DITCH SOYD TON  
02483 CHANNEL LINING CLASS II TON

NOT TO SCALE

EROSION REPAIR DETAILS

COUNTY OF	WARREN	ITEM NO.	3-20016.00
-----------	--------	----------	------------

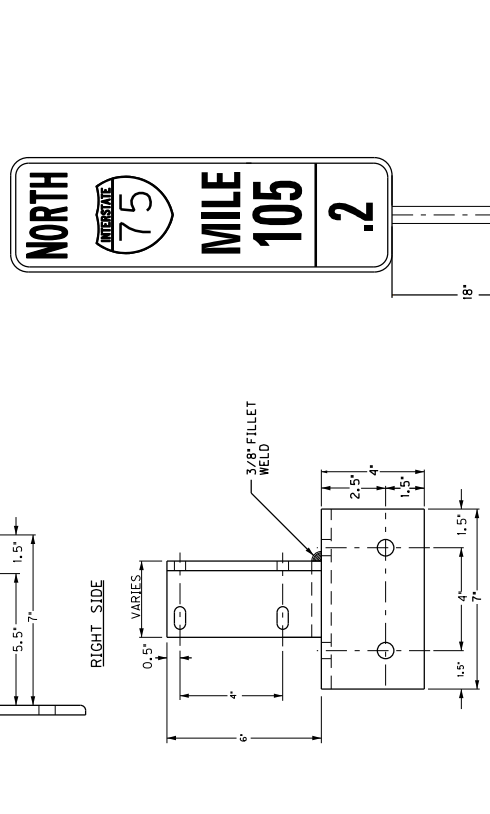
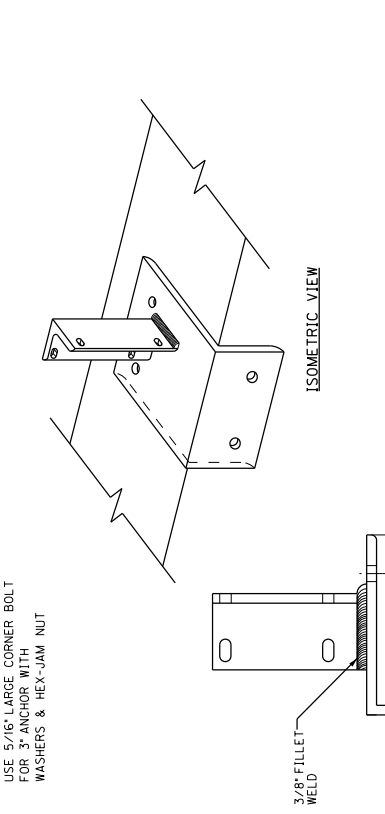

NOTES:  
ALL ROUND HOLES 5/8" O AND ALL OBLONG HOLES ARE 7/16" X 7/8".  
ALL HARDWARE SHALL BE GALVANIZED STEEL OR STAINLESS STEEL AS SPECIFIED.  
ALL WORK AND MATERIALS SHALL BE IN ACCORDANCE WITH STANDARD SPECIFICATIONS.  
ATTACH TO BARRIER WALL USING 1/2" X 13 TPI GRADE 8 BOLTS WITH CONCRETE ANCHOR.  
IF GALVANIZE COATING IS DAMAGED, TREAT WITH COLD GALVANIZING COMPOUND SPRAY.  
MATERIALS:  
ASTM A36 STRUCTURAL ANGLE, 3/8" THICK WITH 3/8" FILLET WELD.

BARRIER MOUNTING BRACKET WITH ENHANCED REFERENCE LOCATION SIGN (BLUE BACKGROUND)

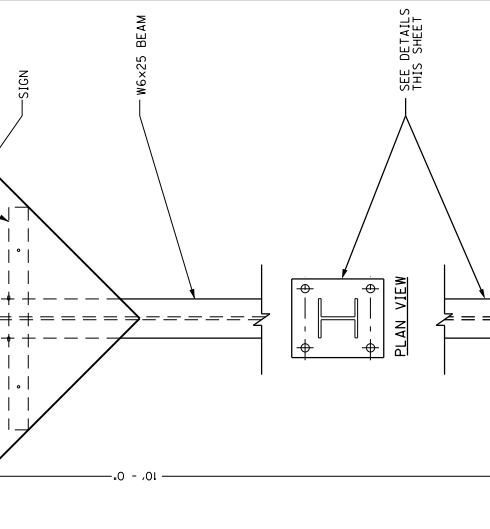
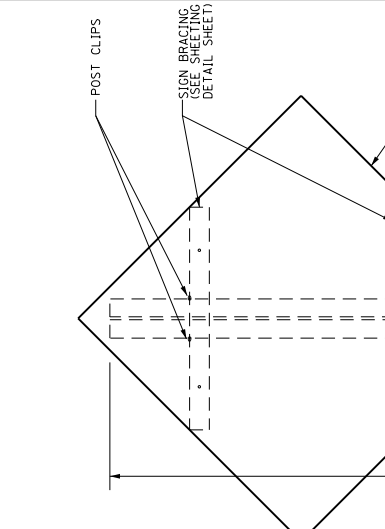

GENERAL NOTES:  
POST CLIPS, BRACKETS AND SIGN TO BE CAPABLE OF SUSTAINING 20 LBS. PER SQUARE FOOT OF SIGN AREA.  
THE COST FOR MAKING THE WALL POST AND ANY HARDWARE REQUIRED TO COMPLETE THE INSTALLATION SHALL BE INCLUDED IN THE COST OF BARRIER WALL POST.  
ANCHOR ALTERNATIVES:  
DRILL 1-3/8" O X 14" HOLE FOR #8 X 16" REINFORCING BAR WITH 1" X 4" MACHINE THREADS. BOND ANCHORS IN HOLE WITH POLYESTER RESIN.  
MATERIAL SPECIFICATIONS:  
ALL STEEL TO BE FROM ASTM A572. ALL HOLES SHALL BE DRILLED. PLATE CUTS SHALL BE SAW CUT AND ALL EDGES GROUND SMOOTH. BOLT MATERIALS SHALL BE ASTM A509 OR EQUIVALENT AND BE GALVANIZED. GALVANIZE AFTER FABRICATION PER ASTM A123.

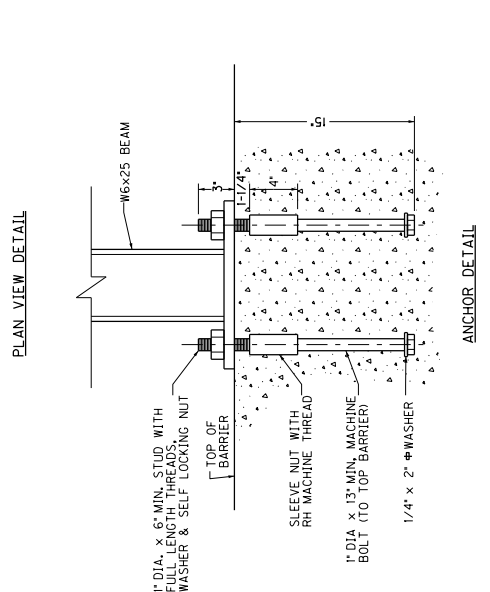
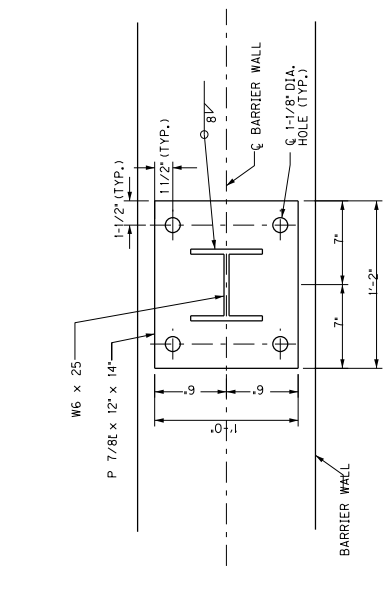

GENERAL NOTES:  
POST CLIPS, BRACKETS AND SIGN TO BE CAPABLE OF SUSTAINING 20 LBS. PER SQUARE FOOT OF SIGN AREA.  
THE COST FOR MAKING THE WALL POST AND ANY HARDWARE REQUIRED TO COMPLETE THE INSTALLATION SHALL BE INCLUDED IN THE COST OF BARRIER WALL POST.  
ANCHOR ALTERNATIVES:  
DRILL 1-3/8" O X 14" HOLE FOR #8 X 16" REINFORCING BAR WITH 1" X 4" MACHINE THREADS. BOND ANCHORS IN HOLE WITH POLYESTER RESIN.  
MATERIAL SPECIFICATIONS:  
ALL STEEL TO BE FROM ASTM A572. ALL HOLES SHALL BE DRILLED. PLATE CUTS SHALL BE SAW CUT AND ALL EDGES GROUND SMOOTH. BOLT MATERIALS SHALL BE ASTM A509 OR EQUIVALENT AND BE GALVANIZED. GALVANIZE AFTER FABRICATION PER ASTM A123.

BARRIER WALL MOUNTING DETAILS

SCALE: NTS

**TRAFFIC CONTROL PLAN**  
**I-65 – WARREN COUNTY**  
**PAGE 1 OF 6**

**TRAFFIC CONTROL GENERAL**

Except as provided herein, maintain and control traffic in accordance with the Standard Specifications and the Standard Drawings, current editions. Except for the roadway and traffic control bid items listed, all other items of work, described herein, necessary to maintain and control traffic, will be paid for with the lump sum bid price to "Maintain and Control Traffic". All lane closures used on the project shall be in compliance with the appropriate Standard Drawings and MUTCD.

Contrary to Section 106.01, traffic control devices used on this project may be new or used in like-new condition at the beginning of the work and maintained in like-new condition until completion of the work. Traffic Control Devices will conform to current MUTCD.

Reduce the speed limit in work areas of I-65 to 55 miles per hour and establish double fines for work zone speeding violations. The extent of these areas within the project limits will be restricted to the proximity of actual work areas as determined by the Engineer. Notify the Engineer a minimum of 12 hours prior to using the double fine signs. At the beginning of the work zone, the "WARNING FINE DOUBLED IN WORK ZONE" signs will be dual mounted. At the end of the work zone, the "END DOUBLE FINE" signs will be dual mounted as well. Remove or cover the signs when the highway work zone does not have workers present for more than a two-hour period of time. Payment for the signs will be at the unit bid price for signs erected. Any relocation or covering of signs will be incidental to "Maintain and Control Traffic."

Night work is required on this project. Obtain approval from the Engineer for the method of lighting prior to its use.

**PROJECT PHASING AND CONSTRUCTION PROCEDURES**

The Contractor shall maintain along I-65 a minimum of two 11-foot lanes in each direction except as noted in this proposal. Access to the ramps and CD road at the Natcher Parkway interchange shall be maintained as directed by the Engineer.

Use a lane closure at all times when work is performed in the adjacent lane or adjacent shoulder. Traffic shall not be allowed to travel on milled surface. When shoulders are utilized, they may need maintenance as deemed necessary by the Engineer to maintain traffic, and this work shall be considered incidental to "Maintain and Control Traffic". All removal of existing striping shall be by water blasting, unless otherwise directed by the Engineer, and this work shall be considered incidental to "Maintain and Control Traffic". Remove edge lines as necessary and approved by the Engineer throughout the project. Provide temporary edge lines through the lane closure area, except as noted in this proposal.

If needed, and as directed by the Engineer, the rumble strips shall be re-constructed after traffic is removed from the shoulders. This shall be paid for with bid item "Shoulder Rumble Strips" for asphalt.

All pavement edge transitions must be smooth and level before opening lanes up to traffic. A lane closure must be in place during all times that pavement edge drop-offs are present (see Pavement Edge Drop-off note).

The Engineer will determine exact locations and limits of pavement repairs at the time of construction. Once removal of pavement at a repair location has begun, work continuously to eliminate the "hole". Place Type III Barricades immediately in front of pavement repair areas. Type III Barricades shall be considered incidental to "Maintain and Control Traffic." As directed by Engineer, the major pavement repairs shall utilize temporary barrier wall with crash cushion.

**TRAFFIC CONTROL PLAN**  
**I-65 – WARREN COUNTY**  
**PAGE 2 OF 6**

Note that lane shifts are required throughout the project. Stripe according to the Standard Drawings and MUTCD.

The Contractor must notify the Engineer at least fourteen (14) days prior to beginning construction in either direction.

**MAINLINE CONSTRUCTION PHASES**

See Typical Sections for MOT and Ramp Access Plan for the Natcher Interchange.

**PHASE 1**

Close the inside lane and shoulder. Fill the inside rumble strip with asphalt Leveling and Wedging PG76-22.

**PHASE 2**

Shift traffic to the inside lane(s) and shoulder. Complete pavement repairs, milling, and resurfacing on outside lanes and shoulder. Complete fog seal of outside paved shoulder area that is not resurfaced. Complete other shoulder, erosion, and drainage repairs identified in the proposal and/or as directed by Engineer. Complete guardrail removal / replacement identified in the proposal and/or as directed by Engineer. Complete permanent striping as directed by Engineer.

**PHASE 3**

Shift traffic to the outside lane(s) and shoulder as shown on the typical sections and/or as directed by the Engineer. Unless directed by the Engineer, temporary striping is not needed for areas where the traffic is shifted onto part of the shoulder. Traffic may be reduced to one lane each night per direction, Sunday night through Friday morning, from 7:00 PM to 6:00 AM and on no holidays, as approved by the Engineer. A law enforcement officer shall be present when traffic is reduced to one lane.

Traffic shall be reopened to two lanes, each direction, by 6:00 AM every day. The Contractor shall be assessed damages of \$5000 for every 15 minutes that one lane of traffic (for each direction) extends beyond 6:00 AM.

Complete any pavement repairs, milling, and resurfacing on inside lane and shoulder. Complete fog seal of inside paved shoulder area that is not resurfaced. Complete other shoulder and drainage repairs identified in the proposal and/or as directed by Engineer. Complete replacement of barrier wall signing.

**PHASE 4**

Complete rumble strips and place permanent striping and markers using temporary lane closures as directed by the Engineer. Final striping may be placed during closures for milling and paving phases, as approved by the Engineer.

**US 231 RAMPS**

The US 231 Ramps may be closed, one at time, to complete milling and paving. Closure, as approved by the Engineer, can occur from 8:00 PM to 6:00 AM Sunday night through Friday morning and on no holidays. All work, for a given ramp, must be completed in one night. Place Type III Barricades across the terminals of the on-ramps as directed by the Engineer.

Traffic shall be detoured to the Cemetery Road interchange to the north, then will follow KY 2158 to US 231 and the Natcher Parkway interchange to the south and follow the Natcher Parkway to US 231. Detours and ramp closures shall be signed according to the MUTCD and current KYTC Standard Drawings. Changeable Message Signs shall be utilized as directed by

**TRAFFIC CONTROL PLAN  
I-65 – WARREN COUNTY  
PAGE 3 OF 6**

the Engineer. The signing plan for the detours developed by the Contractor shall be subject to approval by the Engineer.

This construction can be done concurrent with mainline construction phases.

### **LANE AND SHOULDER CLOSURES**

Limit the lengths of lane and shoulder closures to only that needed for actual operations in accordance with the phasing specified herein, or as directed by the Engineer. Limit lane closures to allow a minimum of two lanes open per direction at any given time except as noted in this proposal.

Mainline traffic may be reduced to one lane in one direction as noted in this proposal. This may occur Sunday night through Friday morning, between 7:00 PM and 6:00 AM or as directed by the Engineer.

Other than the holidays listed in the current Standard Specifications, the Engineer may specify additional days and hours when lane closures are not allowed. Do not leave lane closures in place during prohibited periods.

Contrary to Section 112, lane and shoulder closures will NOT be measured for payment, but are considered incidental to "Maintain and Control Traffic."

### **SIGNS**

Additional traffic control signs in addition to normal lane closure signing detailed on the Standard Drawings may be required by the Engineer. Additional signs needed for lane closures may include, but are not limited to, dual mounted LEFT/RIGHT LANE CLOSED 1 MILE, LEFT/RIGHT LANE CLOSED 2 MILES, LEFT/RIGHT LANE CLOSED 3 MILES, SLOWED/STOPPED TRAFFIC AHEAD. Signage for reduced speed limits and double fine work zones will be furnished, relocated, and maintained by the Contractor.

Contrary to Section 112, individual signs will be measured only once for payment, regardless of how many times they are set, reset, removed, and relocated during the duration of the project. Replacements for damaged signs or signs directed to be replaced by the Engineer due to poor legibility or reflectivity will not be measured for payment.

A quantity of signs has been included for lane shifts, "Roadwork Ahead" signs on entrance ramps, and extra Double Fine signs and Speed Limit signs between interchanges to be paid for only once no matter how many times they are moved or relocated.

Traffic control signs in addition to normal lane closure signing detailed in the Standard Drawings may be required by the Engineer.

### **FLASHING ARROWS**

Flashing arrows will be paid for once, no matter how many times they are moved or relocated. The Department WILL NOT take possession of the flashing arrows upon completion of the work.

### **PORTABLE CHANGEABLE MESSAGE SIGNS**

Provide portable changeable message signs in advance of and within the project at locations to be determined by the Engineer. If work is in progress concurrently in both directions provide additional portable changeable message signs. Place portable changeable message signs one mile in advance of the anticipated queue at each lane closure. As the actual queue lengthens and/or shortens relocate or provide additional portable changeable message signs so that traffic has warning of slowed or stopped traffic at least one mile but not more than two miles before

**TRAFFIC CONTROL PLAN**  
**I-65 – WARREN COUNTY**  
**PAGE 4 OF 6**

reaching the end of the actual queue. The locations designated may vary as the work progresses. The messages required to be provided will be designated by the Engineer. The portable changeable message signs will be in operation always. In the event of damage or mechanical/electrical failure, the Contractor will repair or replace the Portable Changeable Message Sign immediately. Portable Changeable Message Signs will be paid for once, no matter how many times they are moved or relocated. The Department WILL NOT take possession of the signs upon completion of the work.

## **BARRELS**

Barrels are to be used for channelization or delineation and will be incidental to "Maintain and Control Traffic" according to Section 112.04.01. Replacement of damaged barrels due to poor condition or reflectivity, as directed by the Engineer, will not be measured for payment.

## **TRUCK MOUNTED ATTENUATORS**

Furnish and install MUTCD approved Truck Mounted Attenuators (TMAs) in advance of work areas when workers are present less than 12 feet from traffic. If there is less than 500 feet between work sites, only a single TMA will be required at a location directed by the Engineer. Locate the TMAs at the individual work sites and move them as the work zone moves within the project limits. All details of the TMA installations shall be approved by the Engineer. TMAs will not be measured for payment but are incidental to Maintain and Control Traffic. The Department WILL NOT take possession of the TMAs upon completion of the work.

## **PAVEMENT MARKINGS**

If lane closures are in place during nighttime hours, remove or cover the lenses of raised pavement markers that do not conform to the traffic control scheme in use, or as directed by the Engineer. Replace or uncover lenses before a closed lane is reopened to traffic. No direct payment will be made for removing and replacing or covering and uncovering the lenses but will be incidental to "Maintain and Control Traffic".

Place temporary and permanent striping in accordance with Section 112 and Section 714, except that:

1. Temporary and permanent striping will be 6" in width and as shown in standard drawings for interchanges;
2. If the Contractor's operations or phasing requires temporary markings which must be subsequently removed from the ultimate pavement, an approved removable lane tape will be used;
3. Edge lines will be required for temporary striping;
4. Existing, temporary, or permanent striping will be in place before a lane is opened to traffic; and
5. Permanent striping will be Extruded Thermoplastic Marking.

The Contractor is to restripe the roadway back to its original configuration.

Removal of existing and temporary striping shall be incidental to "Maintain and Control Traffic."

## **BARRICADES**

Barricades used for channelization or delineation, and minor pavement repairs shall be incidental to "Maintain and Control Traffic". As directed by the Engineer replacements for

**TRAFFIC CONTROL PLAN  
I-65 – WARREN COUNTY  
PAGE 5 OF 6**

damaged barrels to be replaced due to poor condition or reflectivity will not be measured for payment.

### **TEMPORARY BARRIER WALL**

Concrete Barrier Wall Type 9T with crash cushion shall be in place for the major pavement repairs. This shall be as directed by the Engineer. There shall be a minimum of one (1) delineator per section of wall. Payment will be allowed for the temporary barrier wall, crash cushion, and delineators. Payment will also be allowed for relocation of temporary barrier wall and crash cushion from one major pavement repair to another.

### **PAVEMENT EDGE DROP-OFFS**

Pavement edge drop-offs will be protected by a lane or shoulder closure. Lane closures will be protected with barrels, vertical panels, or barricades as shown on the Standard Drawings.

A pavement edge between opposing directions of traffic or lanes that traffic is expected to cross in a lane change situation shall not have an elevation difference greater than 1 ½". Place warning signs (MUTCD W8-11 or W8-9A) in advance of and at 1500' intervals throughout the drop-off area. Dual posting on both sides of the traveled way shall be required. Pavement edges that traffic is not expected to cross, except accidentally, shall be treated as follows:

- Less than 2" – Protect with a lane closure.
- 2" to 4" – Protect with a lane closure. Place barrels, vertical panels, or barricades every 50 feet. Traffic cones may not be used in place of barrels, panels, and barricades at any time. Construct a wedge with compacted cuttings from milling, trenching, or asphalt mixtures with a 3:1 or flatter slope, when work is not active in the drop-off area. Place Type III Barricades at the beginning of the lane closures, and place additional Type III Barricades spaced at 2,500 feet during the time the lane closure is in place.
- Guardrail Installation – All areas from which guardrail is removed shall be protected by a shoulder closure or other method approved by the Engineer until the new guardrail is installed.

### **TRAFFIC COORDINATOR**

Designate an employee to be Traffic Coordinator. The designated Traffic Coordinator must be certified by an agency qualified for training in this area. The Traffic Coordinator will inspect the project maintenance of traffic once every two hours during the Contractor's operations and at any time a lane closure is in place. The Traffic Coordinator will report all incidents throughout the work zone to the Engineer on the project. The Contractor will furnish the name and telephone number where the Traffic Coordinator can be contacted always.

During any period when a lane closure is in place, the Traffic Coordinator will arrange for personnel to be present on the project always to inspect the traffic control, maintain the signing and devices, and relocate portable changeable message boards as queue lengths change. The personnel will have access on the project to a radio or telephone to be used in case of emergencies or accidents.

This project is designated as a Significant Project in accordance with Section 112.03.03 of the Kentucky Standard Specifications.

**TRAFFIC CONTROL PLAN  
I-65 – WARREN COUNTY  
PAGE 6 OF 6**

## **LAW ENFORCEMENT OFFICER**

Law enforcement officers will be required to be furnished on the project at any time that traffic is reduced to one lane. The contractor will be required to establish an agreement with a local law enforcement agency to provide an officer and police cruiser to be used to warn traffic of lane closures and stopped traffic ahead. The contractor will be responsible to reimburse the agency of the costs for this service. This requirement is solely for the intent of warning traffic of a potential danger ahead and not for the purpose of issuance of traffic violations. The officer should however have authority to issue citations if necessary and at his discretion. Patrolling for speeding and issuance of double fine citations should be performed by a separate officer and the contractor will not be required to reimburse the agency for that operations. **No direct payment will be made** for the providing of law enforcement officers and will be considered **incidental** to “Maintain and Control Traffic”.

## **COORDINATION OF WORK**

The Contractor is advised that other projects may be in progress within or in the near vicinity of this project. The traffic control of those projects may affect this project and the traffic control of this project may affect those projects. The Contractor will coordinate the work on this project with the work of the other Contractors. In case of conflict, the Engineer will determine the relative priority to give to work phasing on the various projects.

## **CONTRACTOR’S AND CONTRACTOR’S EMPLOYEES’ VEHICLES**

Do not use or allow employees to use median crossovers at any time except when inside lanes are closed for construction. In all other phases of construction, change vehicular direction of travel only at interchanges.

## **INCIDENTAL TO MAINTENANCE OF TRAFFIC**

As noted in above paragraphs the following items will not be measured but are considered incidental to “Maintain and Control Traffic.”

- Lane and Shoulder Closures
- Barrels and Replacement of Damaged Barrels
- Type III Barricades
- Removal of Existing and Temporary Striping
- Relocations of Portable Changeable Message Signs
- Relocations of Flashing Arrows
- Relocation or Covering of Signs
- Replacement of Damage Signs
- Maintenance of Shoulders to Maintain Traffic
- Truck Mounted Attenuators
- Removing and Replacing or Covering and Uncovering of Pavement Marker Lenses
- Law Enforcement Officer

COUNTY OF	ITEM NO.
WARREN	3-20016.00

# MAINTENANCE OF TRAFFIC TYPICAL SECTIONS PHASE 1

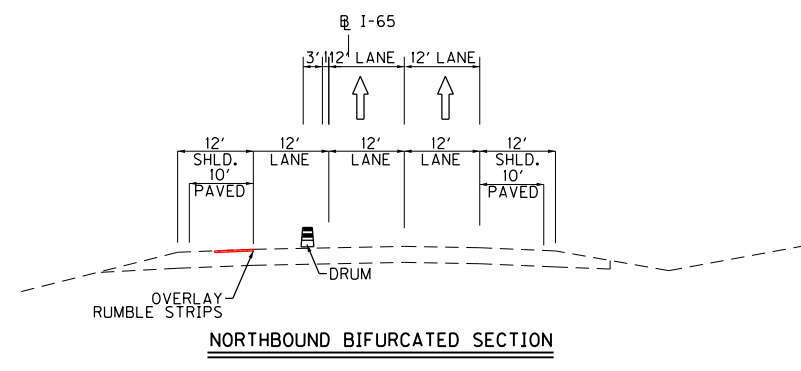
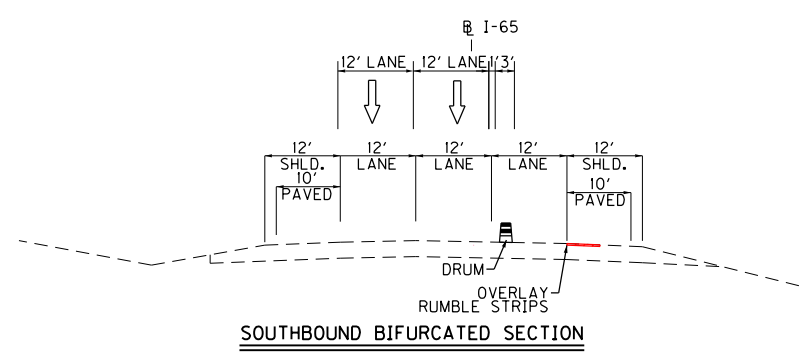
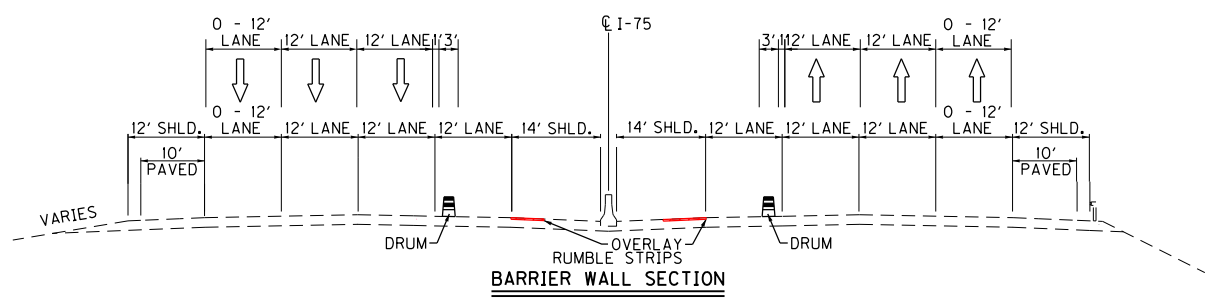

COUNTY OF	ITEM NO.
WARREN	3-20016.00

# MAINTENANCE OF TRAFFIC TYPICAL SECTIONS PHASE 2

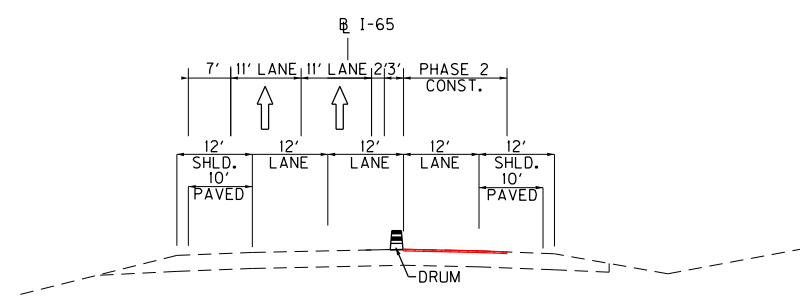
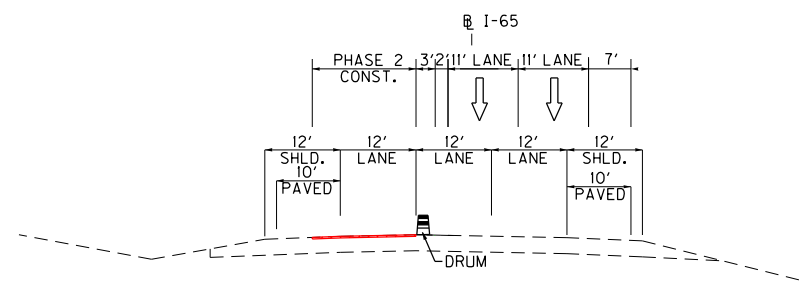
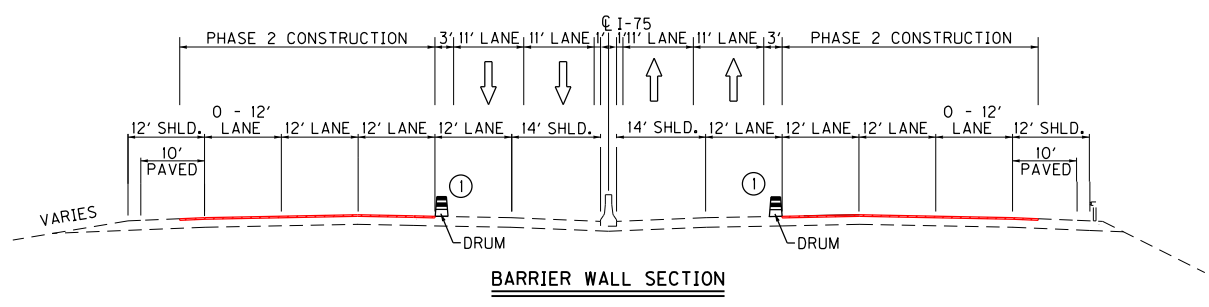

NOTE:  
① DURING MAJOR BLOW UP PAVEMENT REPAIRS, TEMPORARY BARRIER WALL SHALL BE USED IN PLACE OF DRUMS.

NOT TO SCALE

COUNTY OF	ITEM NO.
WARREN	3-20016.00

# MAINTENANCE OF TRAFFIC TYPICAL SECTIONS PHASE 3

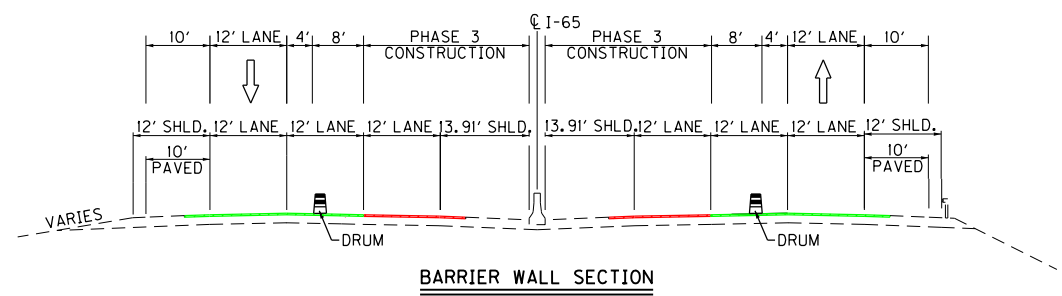

NOTE: WHEN AUXILIARY LANE IS PRESENT, TRAFFIC SHALL BE SHIFTED INTO THE TWO OUTSIDE LANES.

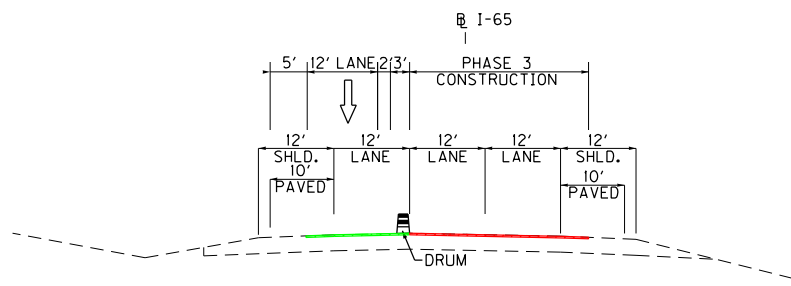

SOUTHBOUND BIFURCATED SECTION

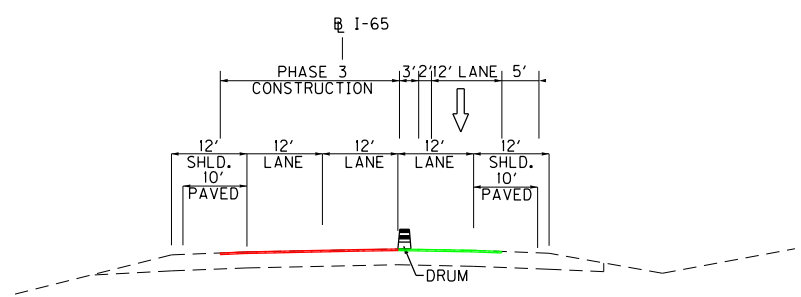

NORTHBOUND BIFURCATED SECTION

COUNTY OF	ITEM NO.
WARREN	3-20016.00

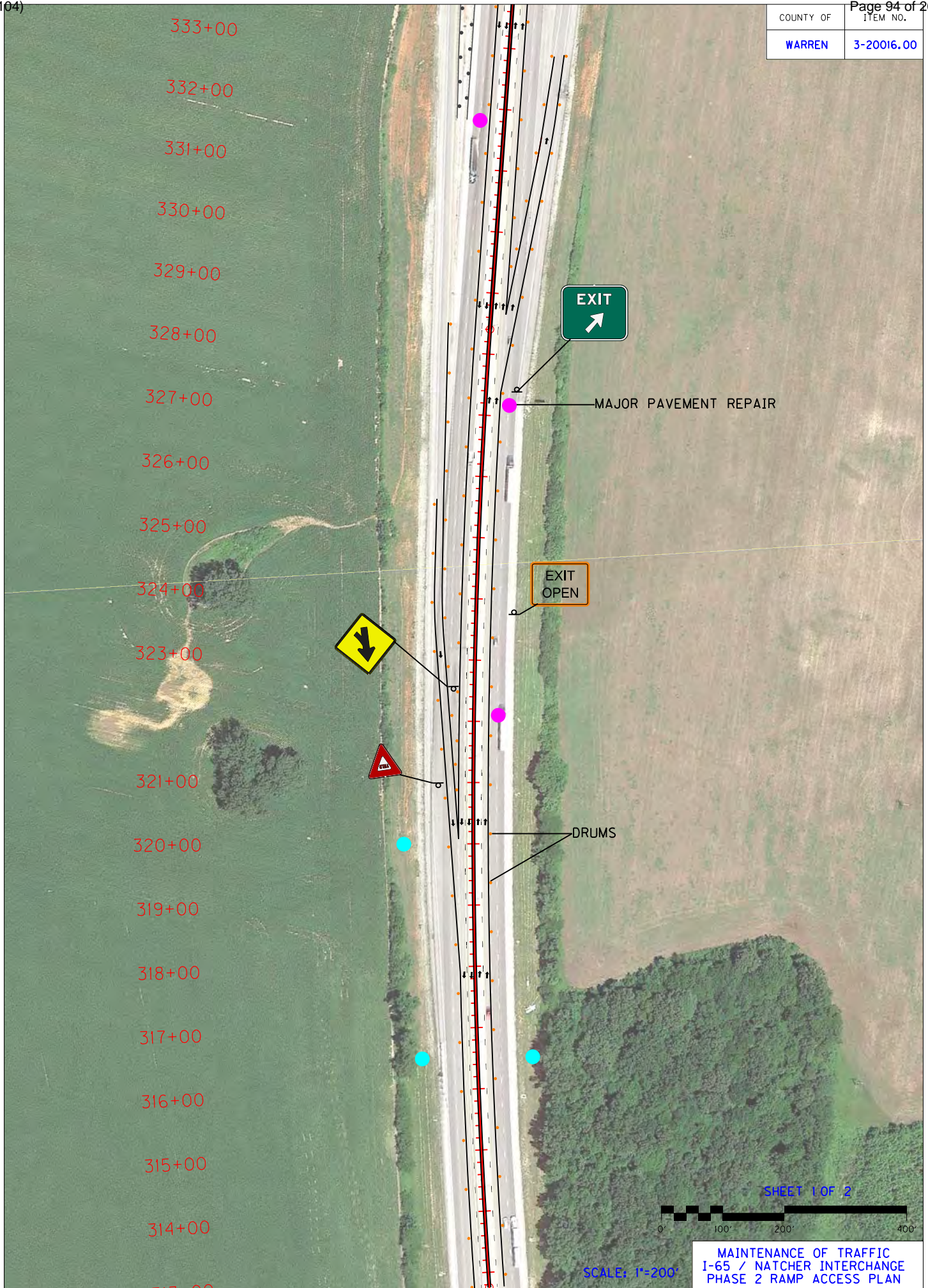

SCALE: 1"=200'

SHEET 1 OF 2  
MAINTENANCE OF TRAFFIC  
I-65 / NATCHER INTERCHANGE  
PHASE 2 RAMP ACCESS PLAN

COUNTY OF	ITEM NO.
WARREN	3-20016.00

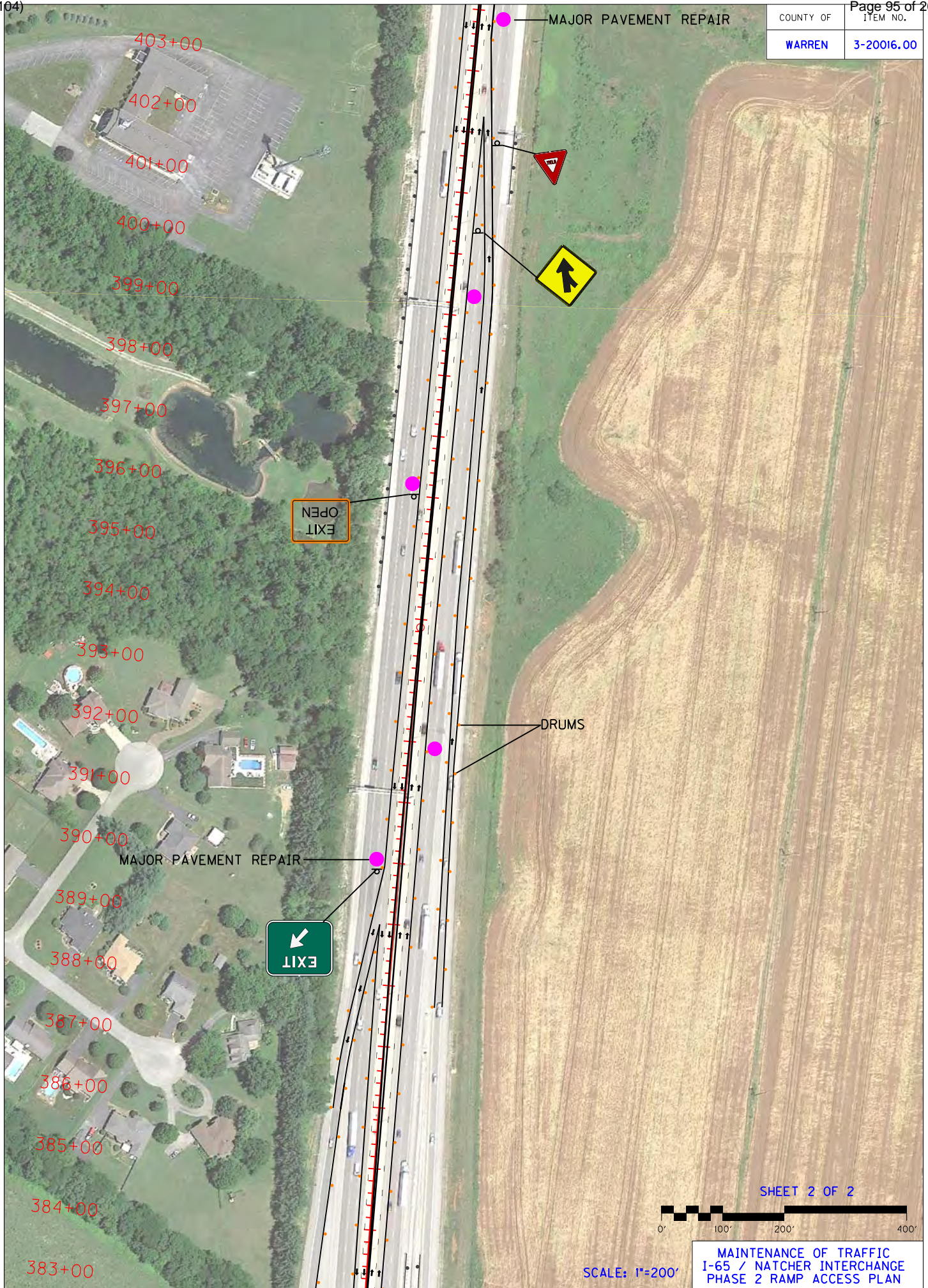

SHEET 2 OF 2

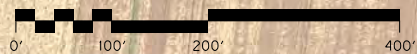

SCALE: 1"=200'  
MAINTENANCE OF TRAFFIC  
I-65 / NATCHER INTERCHANGE  
PHASE 2 RAMP ACCESS PLAN

**SPECIAL NOTE FOR  
ASPHALT MILLING AND TEXTURING**

Begin paving operations immediately after the commencement of the asphalt milling operation. Continue paving operations continuously until completed. Do not allow public traffic to drive on the milled surface. If paving operations are not begun within this time period, liquidated damages will be assessed at the rate prescribed by Section 108.09 of the current Standard Specifications until such time as paving operations are begun.

**Removal of the existing pavement markers prior to the milling operation is considered incidental to the bid item “Asphalt Pavement Milling and Texturing”.**

## **SPECIAL NOTE FOR TYPICAL SECTION DIMENSIONS**

The dimensions shown on the typical sections for pavement and shoulder widths are nominal or typical dimensions. The actual dimensions to be constructed or diamond ground may be varied to fit existing conditions as directed or approved by the Engineer. It is not intended that existing pavement or shoulders be widened unless specified elsewhere in the Proposal.

### **SPECIAL NOTE FOR BEFORE YOU DIG**

The contractor is instructed to call 1-800-752-6007 to reach KY 811, the one-call system for information on the location of existing underground utilities. The call is to be placed a minimum of two (2) and no more than ten (10) business days prior to excavation. The contractor should be aware that owners of underground facilities are not required to be members of the KY 811 one-call Before-U-Dig (BUD) service. The contractor must coordinate excavation with the utility owners, including those whom do not subscribe to KY 811. It may be necessary for the contractor to contact the County Court Clerk to determine what utility companies have facilities in the area.

## **Special Note for Fixed Completion Date And Liquidated Damages**

This project will have a fixed completion date of **October 15, 2021** for completion of all work associated with this project.

Liquidated damages per the Standard Specifications will be charged for each calendar day for any work completed after October 15, 2021

Contrary to Section 108.09 of the Standard Specifications, Liquidated Damages per the Standard Specifications will be charge during the months of December through March for all work that is not completed.

October, 2018

### SPECIAL NOTE FOR FOG SEAL

Except as provided herein, conform to all requirements of the current Standard Specifications for Road and Bridge Construction. Section references are to the Standard Specifications. For chip seal applications, use an approved fog seal material applied in two passes in opposite directions at a rate of 0.05 – 0.08 gallons per square yard with a total rate of 0.10-0.16 gallons per square yard. The emulsion used for fog sealing chip application shall be diluted between 28-32%.

For all other applications, use undiluted approved fog seal material at a rate of 0.12-0.16 gallons per square yard. The recommended emulsions are to be in accordance with AASHTO M208 or M140.

Before applying the fog seal, sweep the chip seal or roadway to remove any loose aggregate, mud, dirt, dust, and other caked material or loose foreign material that may have accumulate on the roadway. Uniformly apply the asphalt emulsion with an asphalt distributor or approved equipment in accordance with Section 406.03.03b except apply at the rates specified herein. Contrary to section 406 of the Standard Specification, material shall maintain a temperature range of 120° to 180° F during application. The fog seal shall be applied when air temperature is at least 50 degrees F and rising and a minimum surface temperature of 70 degrees F.

Any water added to the emulsion must meet the requirements of Section 803 of the Standard Specifications. If placed over a chip/scrub seal treatment, the application shall be a minimum of 5 to a maximum of 10 calendar days after the treatment application.

Adjust operations as necessary and as directed by the engineer to achieve complete, uniform coverage of the application. Correct areas of incomplete coverage by hand spraying or by a second application of material as approved by the engineer. Any fog seal material applied in excess of the requirements shall be covered or removed with a blotter course dry sand as directed by the Engineer.

Payment will be based on the accepted, weighed tons of diluted emulsion applied as specified. Payment per ton of “Asphalt Emulsion for Fog Seal” will be full compensation for all labor, materials, and equipment necessary to prepare the surface for treatment, application of the emulsion, corrective work, and protection of the emulsion until cured. Dry sand used as a blotter course due to excessive use of fog seal will not be considered for payment. Liquid asphalt and fuel adjustments will not be considered for payment for all fog seal applications.

Application Rates of Material.

Properties	Minumum	Maximum
Application rate of emulsion for chip seal Fog seal application required in both directions	0.05	0.08
Application rate of emulsion for non chip seal	0.12	0.16
Emulsion temperature, F	120	180

	KENTUCKY TRANSPORTATION CABINET Department of Highways <b>DIVISION OF CONSTRUCTION</b>	TC 63-72 Rev. 08/2015 Page 1 of 1
<b>GUARDRAIL DELIVERY VERIFICATION SHEET</b>		

**SECTION 1: CONTRACT INFORMATION**

<b>CONTRACT ID</b>	<b>CONTRACTOR</b>
<b>SECTION ENGINEER</b>	<b>DISTRICT &amp; COUNTY</b>

**SECTION 2: GUARDRAIL DESCRIPTIONS & QUANTITIES**

DESCRIPTION	UNIT	QTY. LEAVING PROJECT	QTY. RECEIVED @ BB YARD
Guardrail (includes end treatments & crash cushions)	LF		
Steel Posts	EACH		
Steel Blocks	EACH		
Wood Offset Blocks	EACH		
Back Up Plates	EACH		
Crash Cushion	EACH		
Nuts, Bolts, Washers	Bag/Bckt		
Damaged rail to maintenance facility	LF		
Damaged posts to maintenance facility	EACH		

**SECTION 3: REQUIRED SIGNATURES PART 1** *(required before leaving project site)*

**SECTION ENGINEER'S REPRESENTATIVE NAME** *((Print.))*

<b>SECTION ENGINEER'S REPRESENTATIVE SIGNATURE</b>	<b>DATE</b>
--	-------------

**CONTRACTOR'S REPRESENTATIVE NAME** *(Print.)*

<b>CONTRACTOR'S REPRESENTATIVE SIGNATURE</b>	<b>DATE</b>
--	-------------

**SECTION 4: REQUIRED SIGNATURES PART 2** *(required after arrival at Bailey Bridge Yard)*

**Note:** All material on the truck must be counted & the quantity received column completed before signatures.

**BAILEY BRIDGE YARD REPRESENTATIVE NAME** *(Print.)*

<b>BAILEY BRIDGE YARD REPRESENTATIVE SIGNATURE</b>	<b>DATE</b>
--	-------------

**CONTRACTOR'S REPRESENTATIVE NAME** *(Print.)*

<b>CONTRACTOR'S REPRESENTATIVE SIGNATURE</b>	<b>DATE</b>
--	-------------

**Note:** Payment for the bid item, remove guardrail, will be based upon the quantities shown in the Bailey Bridge Yard received column. Payment will not be made for guardrail removal until the guardrail verification sheets are electronically submitted to the Section Engineer by the Bailey Bridge Yard representative.

<b>Completed form submitted to Section Engineer by</b>	<b>DATE</b>
--	-------------

### SPECIAL NOTE FOR BARCODE LABEL ON PERMANENT SIGNS

**1.0 DESCRIPTION.** Install barcode label on sheeting signs. Section references herein are to the Department’s Standard Specifications for Road and Bridge Construction, current edition.

**2.0 MATERIALS.** The Department will provide the Contractor with a 2 inch x 1 inch foil barcode label for each permanent sheeting sign. A unique number will be assigned to each barcode label.

The Contractor shall contact the Operations and Pavement Management Branch in the Division of Maintenance at (502) 564-4556 to obtain the barcode labels.

**3.0 CONSTRUCTION.** Apply foil barcode label in the lower right quadrant of the sign back. Signs where the bottom edge is not parallel to the ground, the lowest corner of the sign shall serve as the location to place the barcode label. The barcode label shall be placed no less than one-inch and no more than three inches from any edge of the sign. The barcode must be placed so that the sign post does not cover the barcode label.

Barcodes shall be applied in an indoor setting with a minimum air temperature of 50°F or higher. Prior to application of the barcode label, the back of the sign must be clean and free of dust, oil, etc. If the sign is not clean, an alcohol swab shall be used to clean the area. The area must be allowed to dry prior to placement of the barcode label.

Data for each sign shall include the barcode number, MUTCD reference number, sheeting manufacturer, sheeting type, manufacture date, color of primary reflective surface, installation date, latitude and longitude using the North American Datum of 1983 (NAD83) or the State Plane Coordinates using an x and y ordinate of the installed location.

Data should be provided electronically on the TC 71-229 Sign Details Information and TC 71-230 Sign Assembly Information forms. The Contractor may choose to present the data in a different format provided that the information submitted to the Department is equivalent to the information required on the Department TC forms. The forms must be submitted in electronic format regardless of which type of form is used. The Department will not accept PDF or handwritten forms. These completed forms must be submitted to the Department prior to final inspection of the signs. The Department will not issue formal acceptance for the project until the TC 71-229 and TC-230 electronic forms are completed for all signs and sign assemblies on the project.

**4.0 MEASUREMENT.** The Department will measure all work required for the installation of the barcode label and all work associated with completion and submission of the sign inventory data (TC 71-229 and TC 71-230).

The installation of the permanent sign will be measured in accordance to Section 715.

**5.0 PAYMENT.** The Department will make payment for the completed and accepted quantities under the following:

<u>Code</u>	<u>Pay Item</u>	<u>Pay Unit</u>
24631EC	Barcode Sign Inventory	Each

The Department will not make payment for this item until all barcodes are installed and sign inventory is complete on every permanent sign installed on the project. The Department will make payment for installation of the permanent sign in accordance to Section 715. The Department will consider payment as full compensation for all work required under this special note.

### One Sign Post



↑  
2" Wide Post

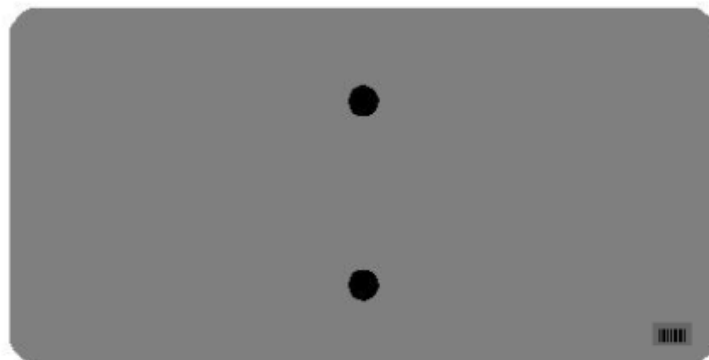
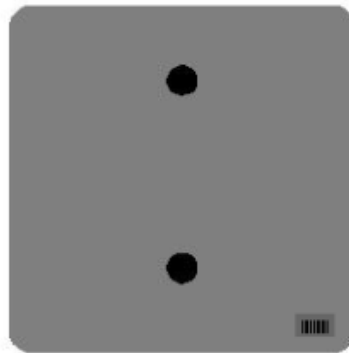

### One Sign Post

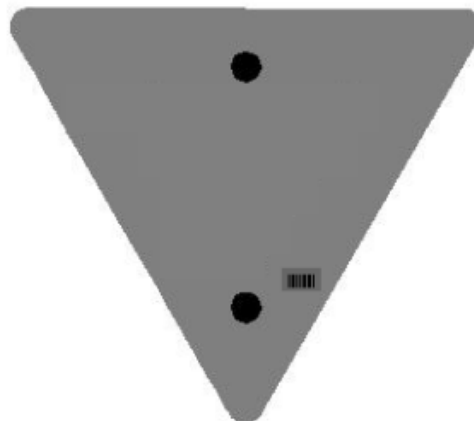
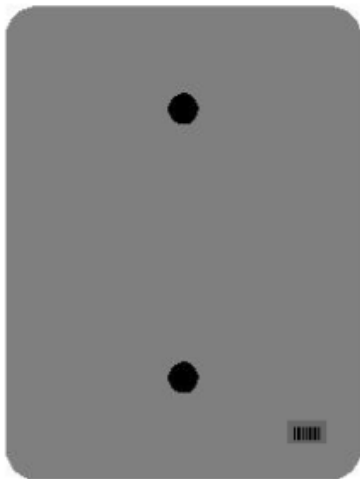
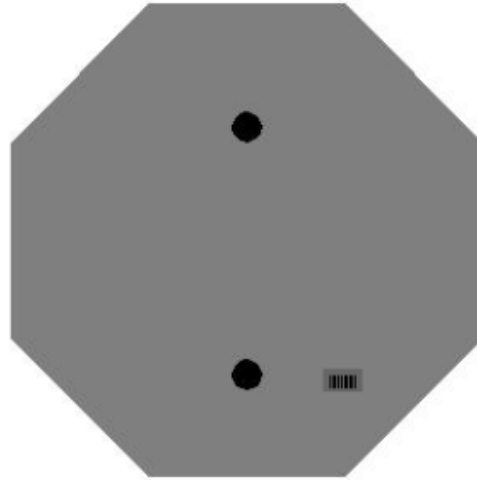
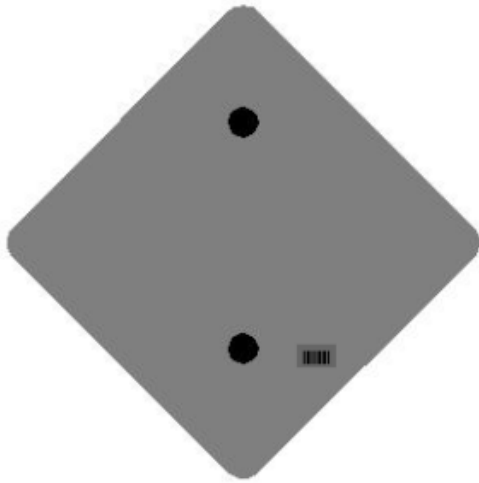

### One Sign Post

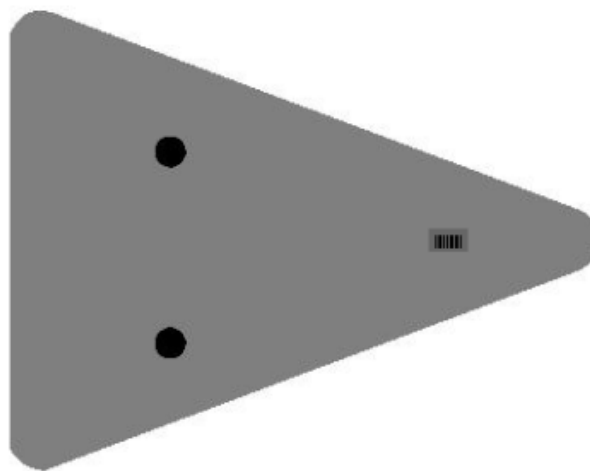
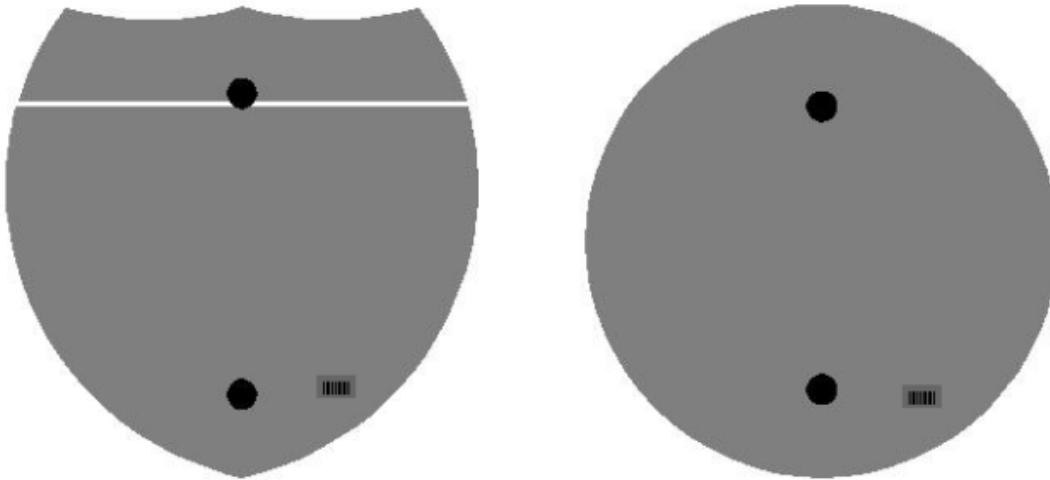

### Double Sign Post

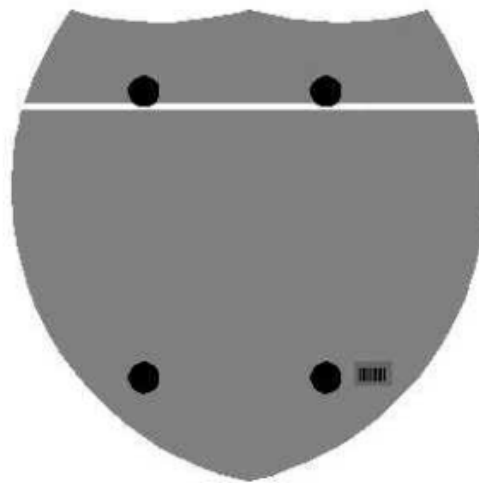

Interstate  
Shield

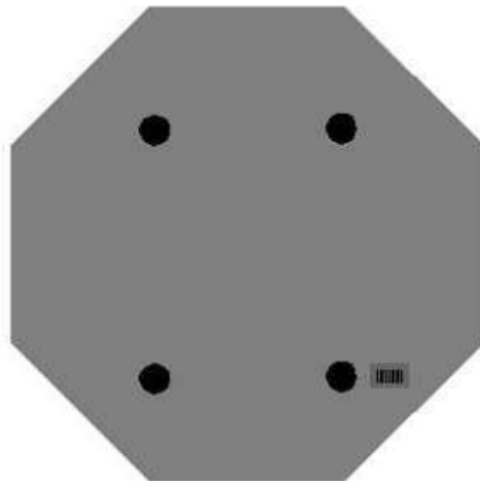

48" Stop

### 2 Post Signs



↑  
2" Wide Post

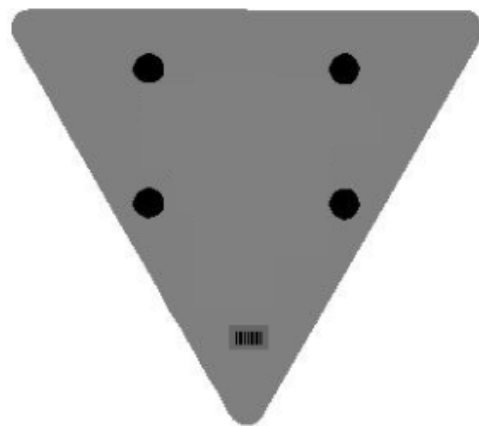

**SPECIAL NOTE FOR LONGITUDINAL PAVEMENT JOINT ADHESIVE**

1. DESCRIPTION. This specification covers the requirements and practices for applying an asphalt adhesive material to the longitudinal joint of the surface course of an asphalt pavement. Apply the adhesive to the face of longitudinal joint between driving lanes for the first lane paved. Then, place and compact the adjacent lane against the treated face to produce a strong, durable, waterproof longitudinal joint.
2. MATERIALS, EQUIPMENT, AND PERSONNEL.

2.1 Joint Adhesive. Provide material conforming to Subsection 2.1.1.

2.1.1 Provide an adhesive conforming to the following requirements:

Property	Specification	Test Procedure
Viscosity, 400 ° F (Pa·s)	4.0 – 10.0	ASTM D 4402
Cone Penetration, 77 ° F	60 – 100	ASTM D 5329
Flow, 140 ° F (mm)	5.0 max.	ASTM D 5329
Resilience, 77 ° F (%)	30 min.	ASTM D 5329
Ductility, 77 ° F (cm)	30.0 min.	ASTM D 113
Ductility, 39 ° F (cm)	30.0 min.	ASTM D 113
Tensile Adhesion, 77 ° F (%)	500 min.	ASTM D 5329, Type II
Softening Point, ° F	171 min.	AASHTO T 53
Asphalt Compatibility	Pass	ASTM D 5329

Ensure the temperature of the pavement joint adhesive is between 380 and 410 °F when the material is extruded in a 0.125-inch-thick band over the entire face of the longitudinal joint.

2.2. Equipment.

2.2.1 Melter Kettle. Provide an oil-jacketed, double-boiler, melter kettle equipped with any needed agitation and recirculating systems.

2.2.2 Applicator System. Provide a pressure-feed-wand applicator system with an applicator shoe attached.

2.3 Personnel. Ensure a technical representative from the manufacturer of the pavement joint adhesive is present during the initial construction activities and available upon the request of the Engineer.

3. CONSTRUCTION.

3.1 Surface Preparation. Prior to the application of the pavement joint adhesive, ensure the face of the longitudinal joint is thoroughly dry and free from dust or any other debris that would inhibit adhesion. Clean the joint face by the use of compressed air.

Ensure this preparation process occurs shortly before application to prevent the return of debris on the joint face.

3.2 Pavement Joint Adhesive Application. Ensure the ambient temperature is a minimum of 40 ° F during the application of the pavement joint adhesive. Prior to applying the adhesive, demonstrate competence in applying the adhesive according to this note to the satisfaction of the Engineer. Heat the adhesive in the melter kettle to the specified temperature range. Pump the adhesive from the melter kettle through the wand onto the vertical face of the cold joint. Apply the adhesive in a continuous band over the entire face of the longitudinal joint. Do not use excessive material in either thickness or location. Ensure the edge of the extruded adhesive material is flush with the surface of the pavement. Then, place and compact the adjacent lane against the joint face. Remove any excessive material extruded from the joint after compaction (a small line of material may remain).

3.3 Pavement Joint Adhesive Certification. Furnish the joint adhesive's certification to the Engineer stating the material conforms to all requirements herein prior to use.

3.4 Sampling and Testing. The Department will require a random sample of pavement joint adhesive from each manufacturer's lot of material. Extrude two 5 lb. samples of the heated material and forward the sample to the Division of Materials for testing. Reynolds oven bags, turkey size, placed inside small cardboard boxes or cement cylinder molds have been found suitable. Ensure the product temperature is 400°F or below at the time of sampling.

4. MEASUREMENT. The Department will measure the quantity of Pavement Joint Adhesive in linear feet. The Department will not measure for payment any extra materials, labor, methods, equipment, or construction techniques used to satisfy the requirements of this note. The Department will not measure for payment any trial applications of Pavement Joint Adhesive, the cleaning of the joint face, or furnishing and placing the adhesive. The Department will consider all such items incidental to the Pavement Joint Adhesive.
5. PAYMENT. The Department will pay for the Pavement Joint Adhesive at the Contract unit bid price and apply an adjustment for each manufacturer's lot of material based on the degree of compliance as defined in the following schedule. When a sample fails on two or more tests, the Department may add the deductions, but the total deduction will not exceed 100 percent.

11N

Pavement Joint Adhesive Price Adjustment Schedule						
Test	Specification	100% Pay	90% Pay	80% Pay	50% Pay	0% Pay
Joint Adhesive Referenced in Subsection 2.1.1						
Viscosity, 400 ° F (Pa•s) ASTM D 3236	4.0-10.0	3.5-10.5	3.0-3.4 10.6-11.0	2.5-2.9 11.1-11.5	2.0-2.4 11.6-12.0	≤1.9 ≥ 12.1
Cone Penetration, 77 ° F ASTM D 5329	60-100	57-103	54-56 104-106	51-53 107-109	48-50 110-112	≤ 47 ≥ 113
Flow, 140 ° F (mm) ASTM D 5329	≤ 5.0	≤ 5.5	5.6-6.0	6.1-6.5	6.6-7.0	≥ 7.1
Resilience, 77 ° F (%) ASTM D 5329	≥ 30	≥ 28	26-27	24-25	22-23	≤ 21
Tensile Adhesion, 77 ° F (%) ASTM D 5329	≥ 500	≥ 490	480-489	470-479	460-469	≤ 459
Softening Point, ° F AASHTO T 53	≥ 171	≥ 169	166-168	163-165	160-162	≤ 159
Ductility, 77 ° F (cm) ASTM D 113	≥ 30.0	≥ 29.0	28.0-28.9	27.0-27.9	26.0-26.9	≤ 25.9
Ductility, 39 ° F (cm) ASTM D 113	≥ 30.0	≥ 29.0	28.0-28.9	27.0-27.9	26.0-26.9	≤ 25.9

Code  
20071EC

Pay Item  
Joint Adhesive

Pay Unit  
Linear Foot

May 7, 2014

### SPECIAL NOTE FOR NON-TRACKING TACK COAT

1. DESCRIPTION AND USEAGE. This specification covers the requirements and practices for applying a non-tracking tack asphalt coating. Place this material on the existing pavement course, prior to placement of a new asphalt pavement layer. Use when expedited paving is necessary or when asphalt tracking would negatively impact the surrounding area. This material is not suitable for other uses. Ensure material can “break” within 15 minutes under conditions listed in 3.2.

2. MATERIALS, EQUIPMENT, AND PERSONNEL.

2.1 Non-Tracking Tack. Provide material conforming to Subsection 2.1.1.

2.1.1 Provide a tack conforming to the following material requirements:

Property	Specification	Test Procedure
Viscosity, SFS, 77 ° F	20 – 100	AASHTO T 72
Sieve, %	0.3 max.	AASHTO T 59
Asphalt Residue <sup>1</sup> , %	50 min.	AASHTO T 59
Oil Distillate, %	1.0 max.	AASHTO T 59
Residue Penetration, 77 ° F	20 max.	AASHTO T 49
Original Dynamic Shear (G*/sin δ), 82 ° C	1.0 min.	AASHTO T 315
Softening Point, ° F	149 min.	AASHTO T 53
Solubility, %	97.5 min.	AASHTO T 44

<sup>1</sup> Bring sample to 212 °F over a 10-15 minute period. Maintain 212 °F for 15-20 minutes or until 30-40 mL of water has distilled. Continue distillation as specified in T59.

2.2. Equipment. Provide a distributor truck capable of heating, circulating, and spraying the tack between 170 °F and 180 °F. Do not exceed 180 °F. Circulate the material while heating. Provide the correct nozzles that is recommend by the producer to ensure proper coverage of tack is obtained. Ensure the bar can be raised to between 14” and 18” from the roadway.

2.3. Personnel. Ensure the tack supplier has provided training to the contractor on the installation procedures for this product. Make a technical representative from the supplier available at the request of the Engineer.

3. CONSTRUCTION.

3.1 Surface Preparation. Prior to the application of the non-tracking tack, ensure the pavement surface is thoroughly dry and free from dust or any other debris that would inhibit adhesion. Clean the surface by scraping, sweeping, and the use of compressed air. Ensure this preparation process occurs shortly before application to prevent the return of debris pavement. If rain is expected within one hour after application, do not apply material. Apply material only when the surface is dry, and no precipitation is expected.

3.2 Non-tracking Tack Application. Ensure the roadway temperature is a minimum of 40 °F and rising during the application of the tack. This material is not suitable for use in colder temperatures. Prior to applying the tack, demonstrate competence in applying the tack according to this note to the satisfaction of the Engineer. Heat the tack in the distributor to between 170 – 180 °F. After initial heating to between 170 – 180 °F, the material may be sprayed between 165 °F and 180 °F. Do not apply outside this temperature range. Apply material at a minimum rate of 0.70 pounds (0.08 gallons) per square yard. Ensure full coverage of the material on the pavement surface. Full coverage of this material is critical. If full coverage is not achieved, material application rate may be increased to ensure full coverage. Do not heat material more than twice in one day.

3.3 Non-tracking Tack Certification. Furnish the tacks certification to the Engineer stating the material conforms to all requirements herein prior to use.

3.4 Sampling and Testing. The Department will require a sample of non-tracking tack be taken from the distributor at a rate of one sample per 15,000 tons of mix. Take two 1 gallon samples of the heated material and forward the sample to the Division of Materials for testing within 7 days. Ensure the product temperature is between 170 and 180 °F at the time of sampling.

4. MEASUREMENT. The Department will measure the quantity of non-tracking tack in tons. The Department will not measure for payment any extra materials, labor, methods, equipment, or construction techniques used to satisfy the requirements of this note. The Department will not measure for payment any trial applications of non-tracking tack, the cleaning of the pavement surface, or furnishing and placing the adhesive. The Department will consider all such items incidental to the non-tracking tack.

5. PAYMENT. The Department will pay for the non-tracking tack at the Contract unit bid price and apply an adjustment for each manufacturer's lot of material based on the degree of compliance as defined in the following schedule. When a sample fails on two or more tests, the Department may add the deductions, but the total deduction will not exceed 100 percent.

Non-Tracking Tack Price Adjustment Schedule						
Test	Specification	100% Pay	90% Pay	80% Pay	50% Pay	0% Pay
Viscosity, SFS, 77 ° F	20 – 100	19 - 102	17 - 18	15 - 16	14	≤13
			103 - 105	106 - 107	108 - 109	≥ 110
Sieve, %	0.30 max.	≤ 0.40	0.41 - 0.50	0.51 - 0.60	0.61 - 0.70	≥ 0.71
Asphalt Residue, %	50 min.	≥49.0	48.5 – 48.9	48.0 – 48.4	47.5-47.9	≤ 47.4
Oil Distillate, %	1.0 max.	≤1.0	1.1-1.5	1.6 - 1.7	1.8-1.9	>2.0
Residue Penetration, 77 ° F	20 max.	≤ 21	22 - 23	24 - 25	26 - 27	≥ 28
Original Dynamic Shear (G*/sin δ), 82 ° C	1.0 min.	≥0.95	0.92 – 0.94	0.90 – 0.91	0.85 - 0.89	≤ 0.84
Softening Point, ° F	149 min.	≥145	142 - 144	140 - 141	138 - 139	≤ 137
Solubility, %	97.5 min.	≥ 97.0	96.8 – 96.9	96.6 – 96.7	96.4 – 96.5	≤ 96.3

<u>Code</u>	<u>Pay Item</u>	<u>Pay Unit</u>
24970EC	Asphalt Material for Tack Non-Tracking	Ton

January 28, 2020

**SPECIAL NOTE FOR HMA ELECTRONIC DELIVERY MANAGEMENT SYSTEM  
(HMA e-Ticketing)**

This Special Note will apply when indicated on the plans or in the proposal. Section references herein are to the Department's Standard Specifications for Road and Bridge Construction current edition.

**1.0 DESCRIPTION.** Incorporate a GPS Fleet Management System for all HMA delivered to the project in order to monitor, track, and report loads of HMA during the construction processes from the point of measurement and loading to the point of incorporation to the project.

**2.0 MATERIALS AND EQUIPMENT.** Submit to the Engineer for approval, no fewer than 30 days prior to HMA placement activities, a GPS fleet management system supplier that can provide a qualified representative for on-site technical assistance during the initial setup, pre-construction verifications, and data management and processing as needed during the Project to maintain equipment.

Provide operator settings, user manuals, training videos, and required viewing/export software for review. Provide equipment that will meet the following:

1. A wireless fleet management or GPS device that is capable of tracking all delivery trucks (both company-owned and third-party) must be installed on all trucks and equipment (dump trucks, belly dumps, side-load dumps, transfer vehicles, pavers, or any other trucks/vehicles) used to transfer and incorporate HMA into the project. KYTC personnel shall have the ability to access Real Time monitoring through the use of a mobile device such as an iPad, smartphone, etc.
2. The fleet management system shall be fully integrated with the Contractor's Load Read-Out scale system at the HMA plant site.
3. The fleet management system shall have the ability to measure and track vehicles and their contents (weights and material types) continuously from the plant site to the project site. The system shall have internal battery backup capabilities due to loss of power, and have the ability to store data if GPS connectivity is lost and transmit that same data when unit re-establishes connectivity. To be considered continuous, no two data points shall be more than 60 seconds apart unless the vehicle is stopped. Duration of stop time for any reason shall be recorded.

**3.0 CONSTRUCTION.** Provide the Engineer with the manufacturer's specifications and all required documentation for data access at the pre-construction conference.

**A. Construction Requirements**

1. Install and operate equipment in accordance with the manufacturer's specifications.
2. Verify the GPS is working within the requirements of this Special Note.

**B. Data Deliverables**

Provide to the Engineer a means in which to gather report summaries by way of iOS apps, web pages, or any other method at the disposal of the Engineer. The Engineer may request data at any time during paving operations.

### 1. Real-time Continuous Data Items

Provide the Engineer access to a GIS map-based data viewer which displays the following information in real-time with a web-based system compatible with iOS and Windows environments.

- Each Truck
  - UniqueTruck ID
  - Truck status
    - Time At Source
    - Time At Destination
    - Time At Paver
    - Time At Scale
    - Time to and from plant/job
    - Time Stopped with Engine Running
  - Time of last transmission
  - Location (Latitude and Longitude in decimal degrees to nearest 0.0000001) every 60 seconds
  - Description of Material being transported (i.e. asphalt base, asphalt surface)
  - Mix Design Number
  - Net Weight of material being transported to the nearest 0.01 ton
  - Running Daily Total of Net Weight of material being transported to nearest 0.01 ton.
  - Project Number
- Scale Location
- Project Location
- Point of Delivery (i.e. paver)

### 2. Daily Summary

The following summary information shall be provided to the Engineer electronically within 4 hours of beginning operations on the next working day

- For each Material
  - List of Individual Loads
    - Contractor Name
    - Project Number
    - Unique Truck ID
    - Net Weight For Payment (nearest 0.01 tons)
    - Date
    - Mix Temperature at Time of Loading, Fahrenheit (to be key entered by plant)
    - Time Loaded
    - Time Unloaded
    - Delivery Location (Latitude/Longitude in decimal degrees to nearest 0.0000001)
- For each Bid Item
  - Total Quantity for Payment (nearest 0.01 tons)

**4.0 MEASUREMENT.** The Department will measure the HMA electronic delivery management system as a lump sum item.

**5.0 PAYMENT.** The Department will make payment for the completed and accepted quantities under the following:

1. Payment is full compensation for all work associated with providing all required equipment, training, and documentation.
2. Delays due to GPS satellite reception of signals or equipment breakdowns will not be considered justification for contract modifications or contract extensions.
3. Payment will be full compensation for costs related to providing the GPS system, including all equipped pavers and transfer vehicles, integration with plant load-out systems, and any software required for the construction and reporting process. All quality control procedures including the GPS systems representative's technical support and on-site training shall be included in the Contract lump sum price.

<u>Code</u>	<u>Pay Item</u>	<u>Pay Unit</u>
24986EC	HMA ELECTRONIC DELIVERY MANAGEMENT SYSTEM	LS

## SPECIAL NOTE FOR EXPERIMENTAL KYCT AND HAMBURG TESTING

### 1.0 General

**1.1 Description.** The KYCT (Kentucky Method for Cracking Test) and the Hamburg test results will help determine if the mixture is susceptible to cracking and rutting. During the experimental phase, data will be gathered and analyzed by the Department to determine the durability of the bituminous mixes. Additionally, the data will help the Department to create future performance based specifications which will include the KYCT and Hamburg test methods.

### 2.0 Equipment

**2.1 KYCT Testing Equipment.** The Department will require a Marshall Test Press with digital recordation capabilities. Other CT testing equipment may be used for testing with prior approval by the Department.

**2.2 Water Baths.** One or more water baths will be required that can maintain a temperature of 77° +/- 1.8° F with a digital thermometer showing the water bath temperature. Also, one water bath shall have the ability to suspend gyratory specimen fully submerged in water in accordance with AASHTO T-166, current edition.

**2.3 Hamburg Wheel Track Testing.** The department encourages the use of the PTI APA/Hamburg Jr. test equipment to perform the loaded wheel testing. The Department will allow different equipment for the Hamburg testing, but the testing device must be approved by the Department prior to testing.

**2.4 Gyratory Molds.** Gyratory molds will be required to assist in the production of gyratory specimens in accordance with AASHTO T-312, current edition.

**2.5 Ovens.** Adequate (minimum of two ovens) will be required to accommodate the additional molds and asphalt mixture necessary to perform the acceptance testing as outlined in Section 402 of the Kentucky Standard Specifications for Road and Bridge Construction, current edition.

**2.6 Department Equipment.** The Department will provide gyratory molds, PINE 850 Test Press with digital recordation, and CT testing equipment to assist during this experimental phase so data can be gathered. Hamburg test specimens will be submitted to the Division of Materials for testing on the PTI APA/Hamburg Jr if the asphalt contractor or district materials office does not have an approved Hamburg testing device.

### 3.0 Testing Requirements

**3.1 Acceptance Testing.** Perform all acceptance testing and aggregate gradation as according with Section 402 and Section 403 of the Kentucky Standard Specifications for Road and Bridge Construction, current edition.

**3.2 KYCT Testing.** Perform crack resistance analysis (KYCT) in accordance with the current Kentucky Method for KYCT Index Testing during the mix design phase and during the plant production of all surface mixtures. For mix design approvals, submit KYCT results on the Department MixPack. For Class 4 mixtures, submit ingredient materials to the Division of Materials for informational verification.

**3.2.1 KYCT Frequency.** Obtain an adequate sample of hot mix asphalt to insure the acceptance testing, gradation, and KYCT gyratory samples can be fabricated and is representative of the bituminous mixture. Acceptance specimens shall be fabricated first, then immediately after, fabricate the KYCT samples with the gyratory compactor in accordance with Section 2.4 of this Special Note. Analysis of the KYCT specimens and gradation will be required one per subplot produced from the same asphalt material and at the same time as the acceptance specimen is sampled and tested.

**3.2.2 Number of Specimens and Conditioning.** Fabricate specimens in accordance with the Kentucky Method for KYCT Index Testing. Contrary to the method, fabricate a minimum of 3 and up to 6 test specimens. The specimens shall be compacted at the temperature in accordance to KM 64-411. KYCT mix design specimens shall be short-term conditioned for four hours at compaction temperature in accordance to KM 64-411. Contrary to the Kentucky Method, plant produced bituminous material shall be short-term conditioned immediately after sampling for two hours at compaction temperature in accordance to KM 64-411. Additionally, fabricated specimens shall be allowed to cool in air (fan is permissible) for 30 minutes +/- 5 minutes and conditioned in a 77 °F water bath for 30 minutes +/- 5 minutes. To insure confidence and reliability of the test results provided by KYCT testing and Hamburg testing, reheating of the asphalt mixture is prohibited.

**3.2.3 Record Times.** For each subplot, record the time required between drying aggregates in the plant to KYCT specimen fabrication. The production time may vary due to the time that the bituminous material is held in the silo. Record the preconditioning time when the time exceeds the one hour specimen cool down time as required in accordance to The Kentucky Method for KYCT Index Testing. The preconditioning time may exceed an hour if the technician is unable to complete the test on the same day or within the specified times as outlined in The Kentucky Method for KYCT Index Testing. The production time and the preconditioning time shall be recorded on the AMAW.

**3.2.4 File Name.** As according to section 7.12 of The Kentucky Method for KYCT Index Testing, save the filename with the following format; "CID\_Approved Mix Number\_Lot Number\_Sublot Number\_Date"

**3.3 Hamburg Testing.** Perform the rut resistance analysis (Hamburg) in accordance to AASTHO T-324, not to exceed 20,000 passes for all bituminous mixtures during the mix design phase and production. For mix design approvals, submit Hamburg results on the Department MixPack. For Class 4 mixtures, submit ingredient materials to the Division of Materials for informational verification.

**3.3.1 Hamburg Testing Frequency.** Perform testing and analysis per lot of material. The plant produced bituminous material sampled for the Hamburg test does not have to be obtained at the same time as the acceptance and KYCT sample. If the Hamburg test sample is not obtained at the same time as the KYCT sample, determine the Maximum Specific Gravity of the KYCT sample in accordance with AASTHO T-209 coinciding with the Hamburg specimens.

**3.3.2 Record Times.** Record the production time as according to section 3.2.3 in this special note. Also record the time that the specimens were fabricated and the time the Hamburg testing was started. All times shall be recorded on the AMAW.

**3.3.3 File Name.** Save the Excel spreadsheet with the following file name; “Hamburg\_CID\_Approved Mix Number\_Lot Number\_Sublot Number\_Date” and upload the file into the AMAW.

#### **4.0 Data**

Submit the AMAW and all test data that was obtained for acceptance, gradation, KYCT, and Hamburg testing within five working days once all testing has been completed for a lot to Central Materials Lab and the District Materials Engineer. Also, any data and or comments that the asphalt contractor or district personnel deem informational during this experimental phase, shall also be submitted to the Central Materials Lab and the District Materials Engineer. Any questions or comments regarding any item in this Special Note can be directed to the Central Office, Division of Materials, Asphalt Branch.

#### **5.0 KYCT Video Demonstration**

<https://www.youtube.com/watch?v=84j0bM45-hg&feature=youtu.be>

#### **6.0 Payment**

Any additional labor and testing equipment that is required to fabricate and test the KYCT and Hamburg specimens shall be considered to be incidental to the asphalt surface line item. The Department will perform the testing for the KYCT and Hamburg specimens if a producer does not possess the proper equipment.

June 3, 2019

WARREN CO. I-65 ~m.p. 14.85  
 NB ~LAT/LONG N 36.832872, W 86.466206  
 WB ~LAT/LONG N 36.832865, W 86.466482  
 STATION 573

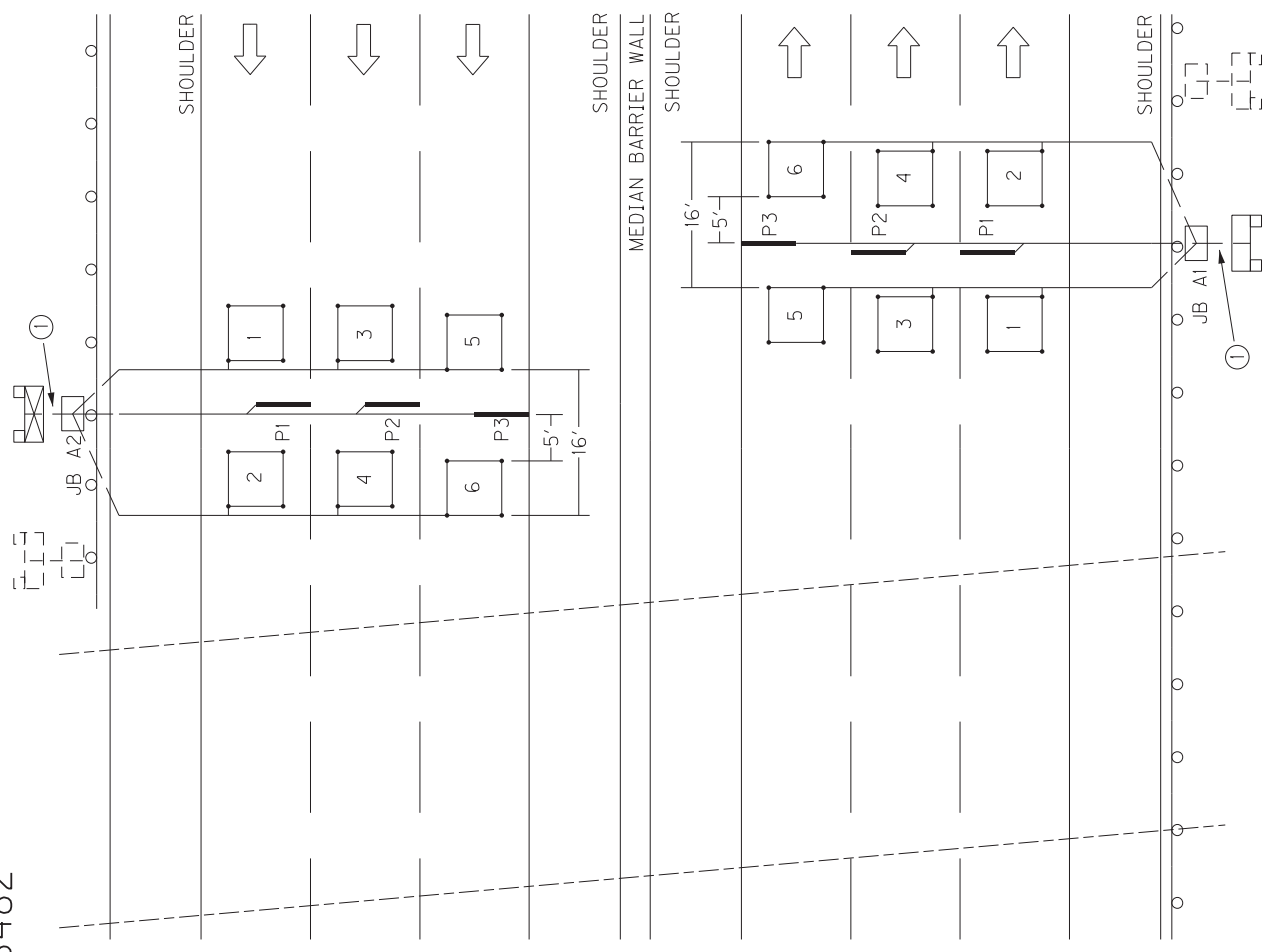
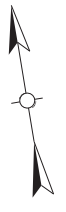

SITE LOCATION IS APPROXIMATE AND WILL BE DETERMINED IN THE FIELD AND APPROVED BY DIVISION OF PLANNING PERSONNEL PRIOR TO ANY CONSTRUCTION.

ALL LOOPS SHALL BE 6'X6' SQUARE AND SHALL BE INSTALLED 16' FROM LEADING EDGE TO LEADING EDGE AS SHOWN. PIEZOELECTRIC SENSORS (PIEZOS) SHALL BE INSTALLED 5' FROM THE EDGE OF LOOPS WITH THE EDGE OF EACH PIEZO FLUSH WITH THE EDGE OF THE CORRESPONDING DRIVING LANE. LOOPS AND PIEZOS SHALL BE INSTALLED SPLICE-FREE TO THE CABINET AND A MINIMUM OF 2' OF WIRE FOR EACH SENSOR SHALL BE COILED INSIDE EACH JUNCTION BOX AND EACH CABINET. ALL LOOPS AND PIEZOS SHALL BE LABELED IN ALL JUNCTION BOXES AND CABINET. DIVISION OF PLANNING PERSONNEL WILL CONNECT THE LOOPS AND PIEZOS INSIDE THE CABINET.

INSTALL ONE (1) 1/4" CONDUIT FROM EACH SAW SLOT TO NEAREST JUNCTION BOX.

INSTALL TWO (2) TYPE A JUNCTION BOXES (JB A1 AND A2)

INSTALL TWO (2) 20"x20"x8" CABINETS MOUNTED TO TWO (2) WOOD POSTS EACH (ONE ON EACH SIDE OF THE ROADWAY).

REMOVE ANY AND ALL EX. TRAFFIC DATA COLLECTION EQUIPMENT AND DISPOSE OF OFF THE JOBSITE.

CODED NOTE:

- ① INSTALL ONE (1) 2" CONDUIT.

WARREN CO. I-65 NB m.p. ~21.49; SB m.p. ~21.27  
NB ~LAT/LONG N 36.923017, W 86.424723  
SB ~LAT/LONG N 36.920285, W 86.426745  
STATION 563

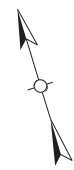

SITE LOCATION IS APPROXIMATE AND WILL BE DETERMINED IN THE FIELD AND APPROVED BY DIVISION OF PLANNING PERSONNEL PRIOR TO ANY CONSTRUCTION.

ALL LOOPS SHALL BE 6'X6' SQUARE AND SHALL BE INSTALLED 16' FROM LEADING EDGE TO LEADING EDGE AS SHOWN. PIEZOELECTRIC SENSORS (PIEZOS) SHALL BE INSTALLED 5' FROM THE EDGE OF LOOPS WITH THE EDGE OF EACH PIEZO FLUSH WITH THE EDGE OF THE CORRESPONDING DRIVING LANE. LOOPS AND PIEZOS SHALL BE INSTALLED SPlice-FREE TO THE CABINET. A MINIMUM OF 2' OF WIRE FOR EACH SENSOR SHALL BE COILED INSIDE EACH JUNCTION BOX AND A MINIMUM OF 2' OF WIRE FOR EACH SENSOR SHALL BE COILED INSIDE THE CABINET. ALL LOOPS AND PIEZOS SHALL BE LABELED IN ALL JUNCTION BOXES AND CABINET. DIVISION OF PLANNING PERSONNEL WILL CONNECT THE LOOPS AND PIEZOS INSIDE THE CABINET.

INSTALL TWO (2) TYPE A JUNCTION BOXES (JB A1 AND A2).

INSTALL ONE (1) 1/4" CONDUIT FROM EACH SAW SLOT TO NEAREST JUNCTION BOX.

INSTALL TWO (2) 20"x20"x8" GALVANIZED STEEL CABINET ON TWO (2) WOOD POSTS EACH.

INSTALL ONE (1) 2" CONDUIT FROM EACH JUNCTION BOX TO EACH CABINET.

REMOVE ALL EX. TRAFFIC DATA COLLECTION EQUIPMENT (CABINET, WOOD POSTS, JUNCTION BOXES, WIRE, CONDUIT) NOT TO BE REUSED AND DISPOSE OF OFF THE PROJECT.

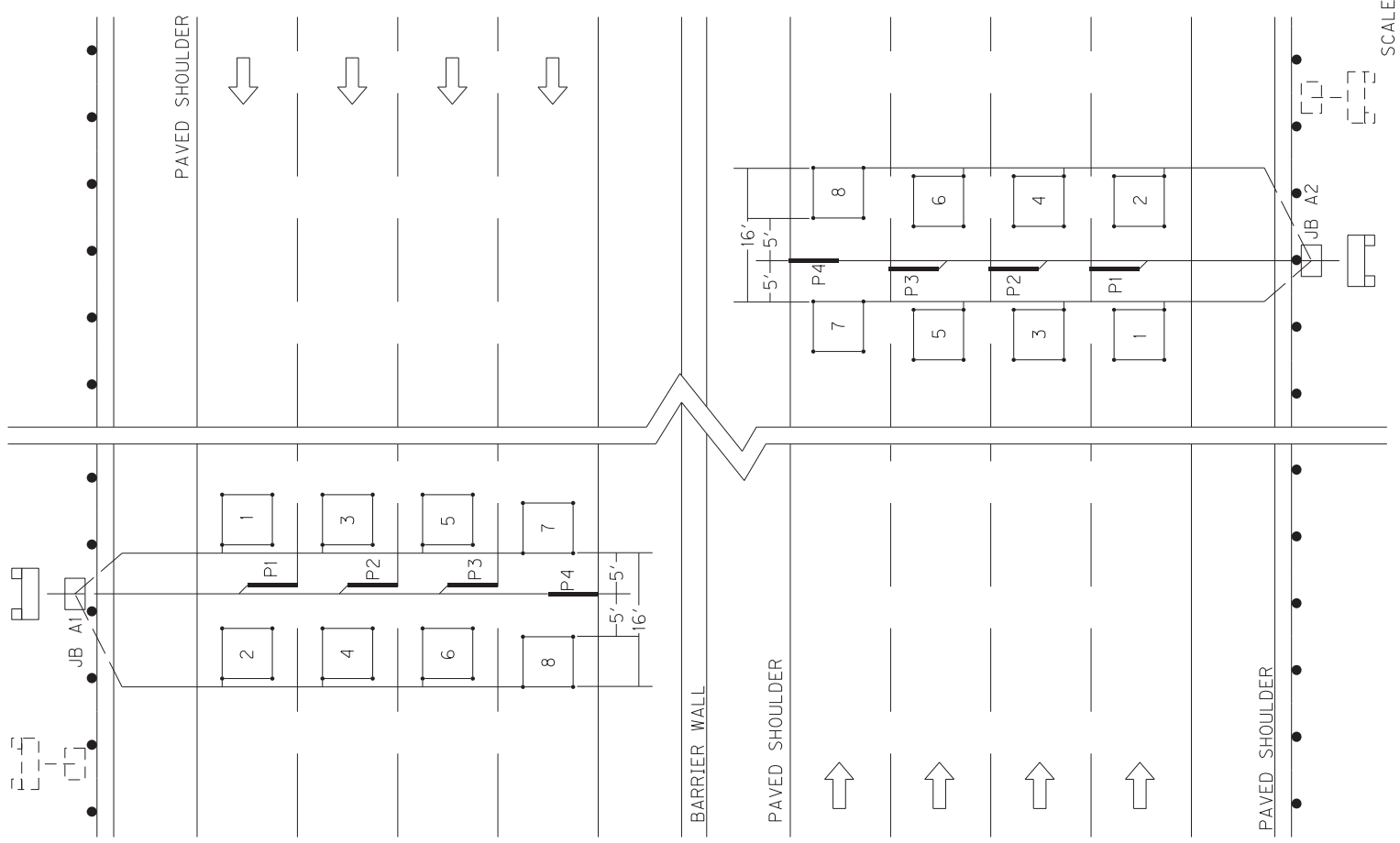

SCALE 1"=20'

WARREN CO. I-65 ~m.p. 23.75  
~LAT/LONG N 36.952809, W 86.406376  
STATION P67

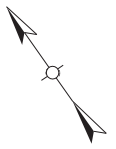

SITE LOCATION IS APPROXIMATE AND WILL BE DETERMINED IN THE FIELD AND APPROVED BY DIVISION OF PLANNING PERSONNEL PRIOR TO ANY CONSTRUCTION.

REMOVE EX. LOOP WIRES, SHIELDED ONE PAIR AND PIEZOELECTRIC SENSOR (PIEZO) CABLES FROM EX. CONDUITS AND JUNCTION BOXES TO BE REUSED AND DISPOSE OF OFF THE PROJECT.

ALL LOOPS SHALL BE 6'X6' SQUARE AND SHALL BE INSTALLED 16' FROM LEADING EDGE TO LEADING EDGE AS SHOWN. PIEZOS SHALL BE INSTALLED 5' FROM THE EDGE OF LOOPS WITH THE EDGE OF EACH PIEZO FLUSH WITH THE EDGE OF THE CORRESPONDING DRIVING LANE. LOOPS AND PIEZOS SHALL BE INSTALLED SPLICE-FREE TO THE CABINET AND A MINIMUM OF 2' OF WIRE FOR EACH SENSOR SHALL BE COILED INSIDE EACH JUNCTION BOX AND 6' OF WIRE FOR EACH SENSOR INSIDE THE CABINET. ALL LOOPS AND PIEZOS SHALL BE LABELED IN ALL JUNCTION BOXES AND CABINET. DIVISION OF PLANNING PERSONNEL WILL CONNECT THE LOOPS AND PIEZOS INSIDE THE CABINET.

INSTALL FIVE (5) TYPE-A JUNCTION BOXES (JB A1, JB A2, JB A3, JB A4 AND JB A5).

INSTALL ONE (1) 1/4" RIGID CONDUIT FROM EACH SAW SLOT TO NEAREST NEWLY INSTALLED TYPE-A JUNCTION BOX.

CODED NOTE:

- ① REUSE EXISTING CONDUIT.
- ② REUSE EXISTING JUNCTION BOX.
- ③ INSTALL 2" RIGID CONDUIT.
- ④ REMOVE AND REPLACE DAMAGED TYPE-A JUNCTION BOX.

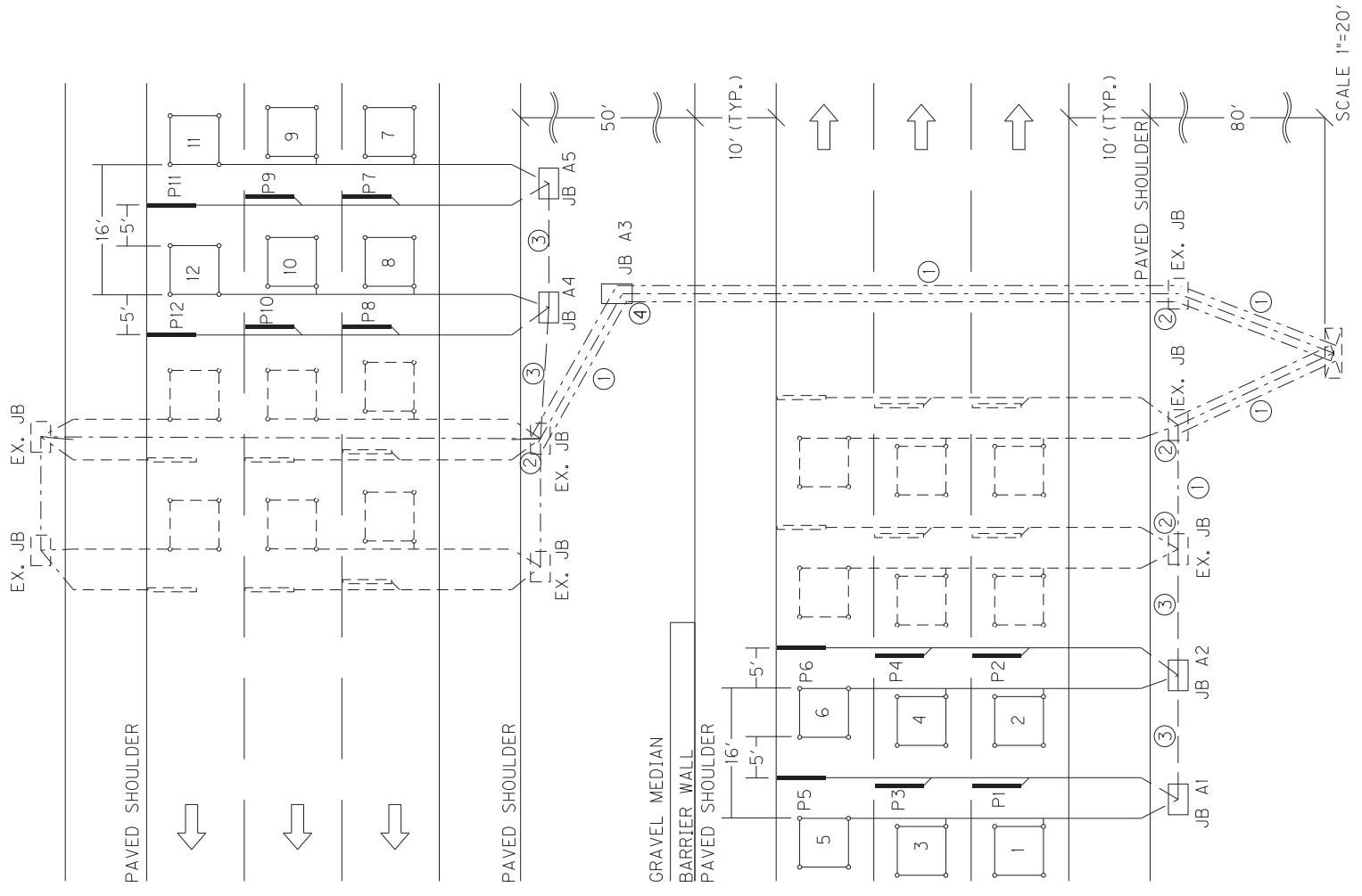

Permanent Traffic Data Acquisition Station  
Estimate Of Quantities

Revised February 2019

**PERMANENT TRAFFIC DATA ACQUISITION STATIONS  
ESTIMATE OF QUANTITIES**

Bid Item Code	Description	Unit	Quantity
4793	CONDUIT 1 ¼ INCH	LIN FT	200
4795	CONDUIT 2 INCH	LIN FT	140
4811	ELECTRICAL JUNCTION BOX TYPE B	EACH	
4820	TRENCHING AND BACKFILLING	LIN FT	320
4821	OPEN CUT ROADWAY	LIN FT	
4829	PIEZOELECTRIC SENSOR	EACH	26
4830	LOOP WIRE	LIN FT	15050
4850	CABLE NO. 14/1 PAIR	LIN FT	
4871	POLE – 35’ WOODEN	EACH	
4895	LOOP SAW SLOT AND FILL	LIN FT	2030
4899	ELECTRICAL SERVICE	EACH	
20213EC	INSTALL PAD MOUNT ENCLOSURE	EACH	
20359NN	GALVANIZED STEEL CABINET	EACH	4
20360ES818	WOOD POST	EACH	8
20391NS835	ELECTRICAL JUNCTION BOX TYPE A	EACH	9
20392NS835	ELECTRICAL JUNCTION BOX TYPE C	EACH	
20468EC	ELECTRICAL JUNCTION BOX 10x8x4	EACH	
21543EN	BORE AND JACK CONDUIT	LIN FT	
23206EC	INSTALL CONTROLLER CABINET	EACH	

Material, Installation, and Bid Item Notes for  
Permanent Traffic Data Acquisition Stations

Revised August, 2018

## **MATERIAL, INSTALLATION, AND BID ITEM NOTES FOR PERMANENT TRAFFIC DATA ACQUISITION STATIONS**

---

### **1. DESCRIPTION**

Except as specified in these notes, all work shall consist of furnishing and installing all materials necessary for permanent data acquisition station equipment installation(s) and shall be performed in accordance with the current editions of:

- The Contract
- Division of Planning Standard Detail Sheets
- Kentucky Transportation Cabinet, Department of Highways, *Standard Specifications for Road and Bridge Construction*
- Kentucky Transportation Cabinet, Department of Highways, Standard Drawings
- National Fire Protection Association (NFPA) 70: *National Electrical Code*
- Institute of Electrical and Electronic Engineers (IEEE), *National Electrical Safety Code*
- Federal Highway Administration, *Manual on Uniform Traffic Control Devices*
- American Association of State Highway and Transportation Officials (AASHTO), *Roadside Design Guide*.
- Standards of the utility company serving the installation, if applicable

The permanent traffic data acquisition station layout(s) indicate the extent and general arrangement of the proposed installation and are for general guidance. Any omission or commission shown or implied shall not be cause for deviation from the intent of the plans and specifications. Information shown on the plans and in this proposal and the types and quantities of work listed are not to be taken as an accurate or complete evaluation of the material and conditions to be encountered during construction. The bidder must draw his own conclusion as to the conditions encountered. The Department of Highways (Department) does not give any guarantee as to the accuracy of the data and no claim will be considered for additional compensation if the conditions encountered are not in accordance with the information shown. If any modifications of the plans or specifications are considered necessary by the Contractor, details of such modifications and the reasons, therefore, shall be submitted in writing to the Engineer for written approval prior to beginning such modified work.

The Contractor shall contact all utility companies and the district utility agent prior to beginning construction to insure proper clearance and shielding from existing and proposed utilities. The Contractor shall use all possible care in excavating on this project so as not to disturb any existing utilities whether shown on the plans or not shown on the plans. Any utilities disturbed or damaged by the Contractor during construction shall be replaced or repaired to original condition by the Contractor at no cost to the department. If necessary, to avoid existing utilities, the Contractor shall hand dig areas where poles or conduit cross utilities.

Material, Installation, and Bid Item Notes for  
Permanent Traffic Data Acquisition Stations

Revised August, 2018

The Contractor shall be responsible for all damage to public and/or private property resulting from his work.

The Contractor shall inspect the project site prior to submitting a bid and shall be thoroughly familiarized with existing conditions. Submission of a bid will be considered an affirmation of this inspection having been completed. The Department will not honor any claims resulting from site conditions.

## 2. MATERIALS

All proposed materials shall be approved prior to being utilized. The Contractor shall submit for material approval an electronic file of descriptive literature, drawings and any requested design data for the proposed materials. After approval, no substitutions of any approved materials may be made without the written approval of the Engineer.

Materials requiring sampling shall be made available a sufficient time in advance of their use to allow for necessary testing.

### 2.1. Anchoring

#### 2.1.1. Anchor and Anchor Rod

Anchor, except rock anchor, shall be expanding type, with a minimum area of 135 square inches.

Anchor rod shall be galvanized steel, double-eye, have a minimum diameter of 5/8 inches, and a minimum length of 84 inches. Minimum holding capacity shall be 15,400 lbs.

Rock anchor shall be galvanized steel, triple-eye, expanding type, with a minimum diameter of 3/4 inch, a minimum 53 inches long, and a minimum tensile strength of 23,000 lb.

#### 2.1.2. Guy Wire and Guy Guard

Guy wire shall be Class A, Zinc-coated, 3/8 inch diameter, high strength grade steel (minimum 10,800 lb.) and galvanized per ASTM A475. Guy guard shall be 8' long, fully-rounded, yellow, and able to be securely attached to the guy wire.

#### 2.1.3. Strandwise for Guy Wire

Strandwise for guy wire shall be 3/8 inch and rated to hold a minimum of 90% of the rated breaking strength (RBS) of the strand used.

### 2.2. Asphalt

Asphalt shall be a minimum CL2 Asph Surf 0.38C PG64-22 and conform to the *Standard Specifications for Road and Bridge Construction*.

### 2.3. Backer Rod

Backer rod shall be 1/2 inch diameter, closed cell polyethylene foam and shall meet or exceed the following physical properties:

- Density (average): 2.0 lbs/cu.ft. (minimum): ASTM D 1622 test method
- Tensile Strength: 50 PSI (minimum): ASTM D 1623 test method
- Compression Recovery: 90% (minimum): ASTM D 5249 test method
- Water Absorption: 0.03 gm/cc (maximum): ASTM C 1016 test method

## **2.4. Cabinets**

### **2.4.1. Galvanized Steel Cabinet**

Galvanized Steel Cabinet shall be constructed of 16 or 14 gauge galvanized steel and shall meet or exceed the industry standards set forth by UL 50 and NEMA 3R. The finish shall be an ANSI 61 gray polyester powder finish inside and out over the galvanized steel. Cabinet shall have minimum inside dimensions of 20 inches high by 20 inches wide by 8 inches deep.

The cabinet shall be equipped with the following:

- Drip shield top
- Seam-free sides, front, and back, to provide protection in outdoor installations against rain, sleet, and snow
- Hinged cover with 16 gauge galvanized steel continuous stainless steel pin.
- Cover fastened with captive plated steel screws, knob or latch
- Hasp and staple for padlocking
- No gaskets or knockouts
- Back panel for terminal block installation
- Post mounting hardware
- Terminal Blocks

### **2.4.2. Anchor Bolt for Pad Mounted Cabinet**

Anchor bolt for pad mounted cabinet shall be galvanized steel with minimum dimensions of 3/8 inch by 6 inches.

## **2.5. Concrete**

Concrete shall be Class A and conform to the *Standard Specifications for Road and Bridge Construction*.

## **2.6. Conduit and Conduit Fittings**

Conduit and conduit fittings shall be rigid steel unless otherwise specified.

Conduit shall be zinc galvanized inside and out and conform to the NEC, UL Standard 6, and ANSI C-80.1.

Rigid Steel Conduit Fittings shall be galvanized inside and out and conform to the NEC, UL Standard 514B, and ANSI C-80.4. Intermediate Metal Conduit (IMC) will not be approved as an acceptable alternative to rigid steel conduit.

## **2.7. Conduit sealant**

Conduit sealant shall be weather-, mold-, and mildew-resistant and chemically resistant to gasoline, oil, dilute acids and bases. Conduit sealant shall be closed cell type and shall meet or exceed the following properties:

- |                                    |  |
|------------------------------------|--|
| • Cure Time                        | 20 minutes max.                                |
| • Density                          | 64.4 kg/m <sup>3</sup> ; 6 lbs/ft <sup>3</sup> |
| • Compressive Strength (ASTM 1691) | 13.8 MPa; 330 or 300 psi                       |

- Tensile Strength (ASTM 1623) 15.9 MPa; 270 or 250 psi
- Flexural Strength (ASTM D790) 14.5 MPa; 460 or 450 psi
- Service Temperature -20 to 200 F

**2.8. Electrical Service Meter Base**

Electrical service meter base shall meet or exceed all requirements of the National Electrical Code and the local utility providing the electrical service.

**2.9. Electrical Service Disconnect**

Electrical service disconnect shall meet or exceed all requirements of the National Electrical Code and the local utility providing the electrical service.

**2.10. Flashing Arrow**

Flashing Arrow shall conform to the *Standard Specifications for Road and Bridge Construction*.

**2.11. Ground Fault Circuit Interrupter (GFCI) Receptacle**

Ground Fault Circuit Interrupter Receptacle shall be 2-pole, 3-wire, 20 Amp, 125 Volt, 60 Hz, NEMA 5-20R configuration and meet or exceed the following standards and certifications:

- NEMA WD-1 and WD-6
- UL 498 and 943
- NOM 057
- ANSI C-73

This item shall include a UL listed, 4 inch x4 inch x 2<sup>1</sup>/<sub>8</sub> inch box with ¾ inch side and end knockouts and a 1½ inches deep, single-receptacle cover to house the GFCI receptacle. Box and cover shall be hot rolled, galvanized steel with a minimum thickness of 0.62 inches.

**2.12. Grounding**

**2.12.1. Ground Rod**

Ground Rod shall be composite shaft consisting of a pure copper exterior (5 mil minimum) that has been inseparably molten welded to a steel core. Ground Rod shall have a minimum diameter of 5/8 inch, a minimum length of 8 feet and shall be manufactured for the sole purpose of providing electrical grounding.

**2.12.2. Ground Rod Clamp**

Ground rod shall be equipped with a one piece cast copper or bronze body with a non-ferrous hexagonal head set screw and designed to accommodate a 10 AWG solid through 2 AWG stranded grounding conductor.

**2.13. Grout**

**2.13.1. Grout for Inductive Loop Installation**

Grout for inductive loop installation shall be non-shrink, shall meet the requirements of the *Standard Specifications for Road and Bridge Construction*,

and shall be included on the KYTC Division of Materials, *List of Approved Materials*.

#### **2.13.2. Grout for Piezoelectric Sensor Installation**

Grout for piezoelectric sensor installation shall be per the piezoelectric sensor manufacturer's recommendation. Grout shall be suitable for installation in both asphalt and Portland cement pavements. Grout shall have a short curing time (tack free in ten minutes; open to traffic in forty minutes; and fully cured within sixty minutes) to prevent unnecessary lane closure time and should be of sufficient consistency to prevent running when applied on road surfaces with a drainage cross slope. Particulate matter within the grout shall not separate or settle and the grout shall not shrink during the curing process.

#### **2.14. Hardware**

Except where specified otherwise, all hardware such as nuts, bolts, washers, threaded ends of fastening devices, etc. with a diameter less than 5/8 inch shall be passivated stainless steel, alloy type 316 or type 304. Stainless steel hardware shall meet ASTM F593 and F594 for corrosion resistance. All other nuts and bolts shall meet ASTM A307 and shall be galvanized.

##### **2.14.1. Conduit Strap**

Conduit strap shall be double-hole, stainless steel, and sized to support specified conduit. Conduit strap shall attach to wood pole or post with two 2 1/4 inch wood screws.

##### **2.14.2. Mounting Strap for Pole Mount Cabinet**

Mounting strap for pole mount cabinet shall be 3/4 inch x 0.03 inch stainless steel; equipped with clips or buckles to securely hold strap.

##### **2.14.3. Metal Framing Channel and Fittings**

Metal framing channel shall be 1 5/8 inches wide galvanized steel that conforms to ASTM A1011 and ASTM A653. One side of the channel shall have a continuous slot with in-turned edges to accommodate toothed fittings.

Fittings shall be punch pressed from steel plates and conform to ASTM A575 and the physical requirements of ASTM A1011.

#### **2.15. Junction Box**

##### **2.15.1. Junction Box Type A, B, or C**

Junction Box Type A, B, or C shall meet or exceed ANSI/SCTE 77-2007, Tier 15. Box shall have an open bottom. A removable, non-slip cover marked "PLANNING" shall be equipped with a lifting slot and attached with a minimum of two 3/8 inch stainless steel hex bolts and washers. Type A Box shall have nominal inside dimensions of 13 inches wide by 24 inches long by 18 inches deep. Type B Box shall have nominal inside dimensions of 11 inches wide by 18 inches long by 12

inches deep. Type C Box shall have nominal inside dimensions of 24 inches wide by 36 inches long by 30 inches deep.

**2.15.2. Aggregate for Junction Box Type A, B, or C**

Aggregate for junction box type A, B, or C shall be gradation size no. 57 and conform to the *Standard Specifications for Road and Bridge Construction*.

**2.15.3. Junction Box 10x8x4**

Junction Box Type 10x8x4 shall be constructed of a UV-stabilized, nonmetallic material or non-rusting metal and be weatherproof in accordance with NEMA 4X. Box shall be equipped with an overhanging door with a continuous durable weatherproof gasket between the body and door. Door shall be hinged with screws, hinge(s) and pin(s) and shall be equipped with a padlockable latch on the side opposite the hinge(s). Junction Box 10x8x4 shall have minimum inside dimensions of 10 inches high by 8 inches wide by 4 inches deep.

**2.16. Maintain and Control Traffic**

Materials for the bid item Maintain and Control Traffic shall conform to the *Standard Specifications for Road and Bridge Construction*, and the KYTC Department of Highways *Standard Drawings*.

**2.17. Piezoelectric Sensor**

Piezoelectric sensor (piezo) shall provide a consistent level voltage output signal when a vehicle axle passes over it, shall have a shielded transmission cable attached, and shall meet the following requirements:

- Dimensions: such that sensor will fit in a ¾ inch wide by 1 inch deep saw cut. Total length shall be 6 feet unless specified otherwise.
- Output uniformity: ± 7% (maximum)
- Typical output level range: 250mV (minimum) from a wheel load of 400 lbs.
- Working temperature range: -40° to 160° F.
- Sensor life: 30 million Equivalent Single Axle Loadings (minimum)

Shielded transmission cable shall be coaxial and shall meet the following requirements:

- RG 58C/U with a high density polyethylene outer jacket rated for direct burial
- Length shall be a minimum of 100 feet. Installations may exceed 100 feet so the piezo shall be supplied with a lead-in of appropriate length so that the cable can be installed splice-free from the piezo to the cabinet.
- Soldered, water resistant connection to the sensor.

One installation bracket for every 6 inches of sensor length shall also be supplied. Piezo shall be a RoadTrax BL Class I or approved equal.

**2.18. Saw Slot Sealant**

Saw Slot Sealant shall be non-shrink, non-stringing, moisture cure, polyurethane

encapsulant suitable for use in both asphalt and concrete pavements. It shall provide a void-free encapsulation for detector loop cables and adequate compressive yield strength and flexibility to withstand heavy vehicular traffic and normal pavement movement.

The cured encapsulant shall meet or exceed the following:

- Hardness (Indentation): 35-65 Shore A, ASTM D2240
- Tensile Strength: 150 psi minimum, ASTM D412
- Elongation: 125% minimum 2 inch/minute pull, ASTM D412
- Tack-free Drying Time: 24 hours maximum, ASTM C679
- Complete Drying Time: 30 hours maximum, KM 64-447
- Chemical Interactions (seven day cure at room temperature, 24-hour immersion, KM 64-446):
  - Motor Oil: No effect
  - Deicing Chemicals: No effect
  - Gasoline: Slight swell
  - Hydraulic Brake Fluid: No effect
  - Calcium Chloride (5%): No effect

#### **2.19. Seeding and Protection**

Material for Seeding and Protection shall be Seed Mixture Type I and conform to the *Standard Specifications for Road and Bridge Construction*.

#### **2.20. Signs**

Materials for signs shall conform to the *Standard Specifications for Road and Bridge Construction*.

#### **2.21. Splicing Materials**

##### **2.21.1. Electrical Tape**

Electrical tape shall be a premium grade, UL-listed, all-weather, vinyl-insulating tape with a minimum thickness of 7 mil. Tape shall be flame retardant and resistant to abrasion, moisture, alkalis, acids, corrosion, and weather (including ultraviolet exposure).

##### **2.21.2. Splice Kit**

Splice kit shall be inline resin-type and rated for a minimum of 600V. Resin shall be electrical insulating-type and shall provide complete moisture and insulation resistance.

#### **2.22. Steel Reinforcing Bar**

Steel reinforcing bar shall be #5 and shall conform to the *Standard Specifications for Road and Bridge Construction*.

#### **2.23. Terminal Block**

Terminal block shall be rated for a minimum of 300 V and have a minimum of six

terminal pairs with 9/16-inch nominal spacing (center to center) for connecting loop and piezoelectric sensor wires to cable assemblies. Terminal block shall have screw type terminal strips to accommodate wire with spade-tongue ends.

#### **2.24. Warning Tape**

Warning tape shall be acid and alkali resistant formulated for direct burial. Tape shall be a minimum of 3 inches wide by 4.0 mils (nominal) thick, and shall be permanently imprinted with a minimum 1 inch black legend on a red background warning of an electric line. Tape shall meet or exceed the following industry specifications:

- American Gas Association (AGA) 72-D-56
- American Petroleum Institute (API) RP 1109
- American Public Works Association (APWA) Uniform Color Code
- Department of Transportation (DOT) Office of Pipeline Safety USAS B31.8
- Federal Gas Safety Regulations S 192-321 (e)
- General Services Administration (GSA) Public Buildings Service Guide: PBS 4-1501, Amendment 2
- National Transportation Safety Board (NTSB) PSS 73-1
- Occupational Safety and Health Administration (OSHA) 1926.956 (c) (1)

#### **2.25. Wire and Cable**

All cable and wire shall be plainly marked in accordance with the National Electrical Code (NEC).

##### **2.25.1. Loop Wire**

Loop wire shall be 14 AWG, stranded, copper, single conductor, and shall conform to the International Municipal Signal Association (IMSA) Specification No. 51-7.

##### **2.25.2. Cable No. 14/1 Pair**

Cable No. 14/1 pair loop lead-in cable shall be 14 AWG, stranded, copper paired, electrically shielded conductors, and shall conform to IMSA 19-2.

##### **2.25.3. Grounding conductor**

Grounding conductor and bonding jumper shall be solid or stranded, 4 AWG bare copper.

##### **2.25.4. Service Entrance Conductor**

Service entrance conductor shall be stranded, copper, Type USE-2, sized as required to comply with the NEC.

##### **2.25.5. Terminal for electrical wire or cable**

Terminal for electrical wires or cables shall be insulated, solderless, spade tongue terminals of correct wire and stud size. Terminal for electrical wires or cables shall be incidental to the wire or cable (including piezoelectric sensor transmission cable) to be connected to terminal strips.

Material, Installation, and Bid Item Notes for  
Permanent Traffic Data Acquisition Stations

Revised August, 2018

**2.26. Wood Post**

Wood post shall be Southern Pine pretreated to conform to the American Wood Preservers' Association (AWPA) C-14 or UC4B and shall have minimum dimensions of 4 inches by 4 inches by 8 feet long (for Galvanized Steel Cabinet) or 4 feet long (for Junction Box 10x8x4), sawed on all four sides with both ends square.

**2.27. Wooden Pole**

Wooden pole shall be a Class IV wood pole of the length specified and shall conform to the *Standard Specifications for Road and Bridge Construction* except the pole shall be treated in accordance with AWPA P9 Type A.

### 3. CONSTRUCTION METHODS

The plans indicate the extent and general arrangement of the installation and are for guidance. When the Contractor deems any modifications to the plans or specifications necessary, details of such changes and the reasons shall be submitted in writing to the engineer for written approval prior to beginning the modified work.

After the project has been let and awarded, the Division of Construction shall notify the Division of Planning of the scheduled date for a Pre-Construction meeting so that prior arrangements can be made to attend. This will allow the Division of Planning an opportunity to address any concerns and answer any questions that the Contractor may have before beginning the work.

The Division of Planning Equipment Management Team (502-564-7183) shall be notified a minimum of seven days before any work pertaining to these specifications begins to allow their personnel the option to be present during installation.

Unless otherwise specified, installed materials shall be new.

Construction involving the installation of loops or piezoelectric sensors shall not be performed when the temperature of the pavement is less than 38°F.

A final inspection will be performed by a member of the Central Office Division of Planning equipment staff after the installation is complete to verify that the installation is in compliance with the plans and specifications.

Any required corrective work shall be performed per the *Standard Specifications for Road and Bridge Construction*.

#### 3.1. Anchoring

Furnish: Anchor, anchor rod, guy wire, strand vise, guy guard.

Anchor shall be installed in relatively dry and solid soil. Rock anchor shall be installed in solid rock. Excavate the hole at a 45° to 60° angle in line with the guy (hole size shall be slightly larger than the expanded anchor – see manufacturer's recommendation). Attach rod to anchor, install assembly into hole, and expand anchor. Backfill and tamp entire disturbed area. The effectiveness of the anchor is dependent upon the thoroughness of backfill tamping. Attach guy to strand vise on pole and anchor rod and tighten to required tension. Install guy guard on guy.

#### 3.2. Bore and Jack Pipe – 2”

Furnish: Steel Encasement Pipe, 2”

Bore and jack pipe – 2” shall conform to the Section 706 of the *Standard Specifications for Road and Bridge Construction*.

### **3.3. Cleanup and Restoration**

Furnish: Seed Mix Type 1 (as required); fertilizer (as required); agricultural limestone (as required); mulch or hydromulch (as required); tackifier (as required).

The Contractor shall be responsible for repairing any damage to public and/or private property resulting from his work. Upon completion of the work, restore all disturbed highway features in like kind design and materials. This shall include filling any ruts and leveling ground appropriately. Contractor shall dispose of all waste and debris off the project. Sow all disturbed earthen areas with Seed Mix Type 1 per Section 212 of the *Standard Specifications for Road and Bridge Construction*. All materials and labor necessary for cleanup and restoration shall be considered incidental to other bid items.

### **3.4. Conduit**

Furnish: Conduit; conduit fittings; bushings (grounding where required); LB condulets (as required); weatherheads (as required); conduit straps; hardware; conduit sealant.

Conduit that may be subject to regular pressure from traffic shall be laid to a minimum depth of 24 inches below grade. Conduit that will not be subject to regular pressure from traffic shall be laid to a minimum depth of 18 inches below grade.

Conduit ends shall be reamed to remove burrs and sharp edges. Cuts shall be square and true so that the ends will butt together for the full circumference of the conduit. Tighten couplings until the ends of the conduit are brought together. Do not leave exposed threads. Damaged portions of the galvanized surfaces and untreated threads resulting from field cuts shall be painted with an Engineer-approved, rust inhibitive paint. Conduit bends shall have a radius of no less than 12 times the nominal diameter of the conduit, unless otherwise shown on the plans.

Contractor shall install a bushing (grounding bushing where required) on both ends of all conduits. Cap spare conduits on both ends with caps or conduit sealant.

Conduit openings in junction boxes and cabinets shall be waterproofed with a flexible, removable conduit sealant, working it around the wires, and extending it a minimum 1 inch into the end of the conduit.

After the conduit has been installed and prior to backfilling, the conduit installation shall be inspected and approved by the Engineer.

### **3.5. Electrical Service**

Furnish: Meter base, service disconnect, wire, GFCI AC duplex receptacle with box and cover; conduit, conduit fittings, bushings (grounding where required); LB condulets (as required); weatherhead; conduit straps; hardware; conduit sealant; ground rod with clamp; grounding conductor.

Prior to any construction, the Contractor shall initiate a work order with the local power

company for the installation of electrical service to the site. A representative from the Division of Planning and the local power company shall be consulted prior to choosing an exact location for the pole. The Contractor shall clear the right-of-way for the electrical service drop.

Contractor shall obtain electrical inspections, memberships, meter base, service disconnect and any other requirements by the utility serving the installation and pay all fees as required.

Install meter-base and disconnect panel with a 30-ampere, fused, circuit breaker inside. Install a manufactured weatherproof hub connectors to connect the conduit to the top of the meter base and service disconnect.

Install a rigid  $\frac{3}{4}$  inch conduit with three 8 AWG service conductors from the cabinet, through the service disconnect to the meter base and a  $1\frac{1}{4}$ " conduit with three 8 AWG service conductors from the meter base to a weatherhead two feet from the top of the electrical service pole. Install conduit straps 30 inches on center and provide a drip loop where the wire enters the weatherhead. Splice electric drop with service entrance conductors at the top of the pole.

The limit of conduit incidental to "Install Electrical Service" for a pad mounted cabinet is 24 inches beyond face of service pole.

Install a 120-volt, 20-amp GFCI AC duplex receptacle with box and cover in the automatic data recorder (ADR) cabinet.

Install a ground rod with clamp. Install a grounding conductor wire from the meter base, through the disconnect panel, to the ground rod clamp. Install grounding conductor in  $1\frac{3}{4}$ " conduit from service disconnect to ground rod.

After completing the installation and before the electrical service is connected, obtain a certificate of compliance from the Kentucky Department of Housing, Buildings and Construction, Electrical Inspection Division.

### **3.6. Flashing Arrow**

Furnish: Arrow Panel

Construction of Flashing Arrow shall conform to the *Standard Specifications for Road and Bridge Construction*.

### **3.7. Galvanized Steel Cabinet**

Furnish: Cabinet; wood posts; concrete; conduit fittings; metal framing channel; pipe clamp; terminal block(s); spade tongue wire terminals; wire labels; hardware.

Where right-of-way allows, locate the cabinet such that it is outside the clear zone in accordance with the *Roadside Design Guide*. Install Cabinet such that the door of the

cabinet faces the roadway.

Excavate as required and install wood posts to a depth of 36 inches and place concrete around posts as shown on the standard detail sheets. Install metal framing channel with pipe clamp between posts.

Install Cabinet on wood posts 38 inches above the finished grade as shown on the standard detail sheets. Install a unistrut between posts when two posts are specified.

Install the required number of terminal blocks on the cabinet back plate. Install a spade tongue terminal on each loop and piezo sensor wire entering the cabinet and connect wires to terminal block(s). Wiring shall be neat and orderly. Label all wires and cables inside cabinet.

Install conduit from ground to cabinet and attach to pipe clamp. Install locknuts to attach conduit to cabinet and install a conduit bushing as shown on the standard detail sheets.

### **3.8. Grounding**

Furnish: Ground rod with clamp; grounding conductor.

At sites with electrical or solar service, all conduits, poles, and cabinets shall be bonded to ground rods and the electrical system ground to form a complete grounded system.

Install such that top of ground rod is a minimum of 3 inches below finished grade.

Grounding systems shall have a maximum 25 ohms resistance to ground. If the resistance to ground is greater than 25 ohms, two or more ground rods connected in parallel shall be installed. Adjacent ground rods shall be separated by a minimum of 6 feet.

### **3.9. Install Pad Mount Enclosure**

Furnish: Concrete; anchor bolts with washers and nuts; conduit; conduit fittings; conduit grounding bushings; ground rod with clamp; grounding conductor; conduit sealant; wooden stakes (where required); wire labels; hardware.

The Contractor shall be responsible for securing the enclosure from the Central Office Division of Planning Warehouse in Frankfort and transporting it to the installation site.

Where right-of-way allows, locate the enclosure such that it is outside the clear zone in accordance with the *Roadside Design Guide*.

Excavate as required, and place concrete to construct the enclosure foundation as specified on the standard detail sheets. Install enclosure on the concrete base such that the door(s) of the enclosure opens away from traffic (hinges away from traffic). Install anchor bolts, washers, and nuts to secure the enclosure to the foundation.

Install ground rod with clamp and install one ¾ inch rigid conduit from enclosure base to

ground rod. Install a grounding conductor from ground rod to enclosure base and bond to each conduit bushing in the base.

Install one  $\frac{3}{4}$  inch rigid steel conduit for electrical service from the base of the enclosure to 24 inches beyond the concrete base. Make all field wiring connections to the electrical service, as applicable.

If electrical service is not provided as a bid item in the contract, plug conduit on both ends with a cap, conduit sealant, or electrical tape. Mark the location of the buried conduit end with a wooden stake labeled "3/4 in. conduit."

Install specified rigid steel conduit(s) into the base of the enclosure for sensor wire entry. Install one spare 2 inch conduit from the enclosure base to 2 feet beyond the concrete base. Plug spare conduit on both ends with a cap, conduit sealant or electrical tape.

The limit of all conduits incidental to "Install Pad Mount Enclosure" is 24 inches beyond the edge of the concrete base.

Wiring in enclosure shall be neat and orderly. Label all wires and cables inside enclosure. KYTC personnel will furnish and install terminal blocks and connect sensors to terminal blocks.

### **3.10. Install Controller Cabinet**

Furnish: Mounting brackets; mounting straps; conduit; LB condulets; conduit fittings; conduit grounding bushings; ground rod with clamp; grounding conductor; cable staples; conduit sealant; wooden stakes (where required); wire labels; hardware.

The Contractor shall be responsible for securing the cabinet from the Central Office Division of Planning Warehouse in Frankfort and transporting it to the installation site. Any existing holes in the cabinet not to be reused shall be covered or plugged to meet NEC requirements.

Install mounting brackets and secure cabinet to pole with mounting straps.

Install a ground rod with clamp. Install grounding conductor in 1- $\frac{3}{4}$ " conduit from cabinet to ground rod.

Install one  $\frac{3}{4}$  inch rigid steel conduit with two lb condulets from cabinet to electrical service disconnect box. Make all field wiring connections to the electrical service, as applicable.

If electrical service is not provided as a bid item in the contract, plug conduit on both ends with cap, plumbers putty, conduit sealant, or electrical tape. Mark the location of the buried conduit end with a wooden stake labeled "3/4 in. conduit".

Install specified rigid steel conduit(s) and type LB conduit(s) into the bottom of the

cabinet for sensor wire entry. The limit of conduits incidental to "Install Controller Cabinet" is 24 inches beyond the face of the pole.

Wiring in cabinet shall be neat and orderly. Label all wires and cables inside cabinet. KYTC personnel will furnish and install terminal blocks and connect sensors to terminal blocks.

### **3.11. Junction Box Type 10x8x4**

Furnish: Junction box; wood post; conduit fittings; wire labels; hardware.

Where right-of-way allows, locate the junction box such that it is outside the clear zone in accordance with the Roadside Design Guide.

Excavate as required and install wood post(s) to a depth of 18 inches. Install junction box on wood post such that the bottom of the box is 18 inches above the finished grade as shown on the standard detail sheets. Box shall be installed with four (4) 2½ inch wood screws and washers.

Install locknuts to attach conduit to junction box and install a conduit bushing as shown on the standard detail sheets.

Wiring inside box shall be neat and orderly. Label all wires and cables inside box.

### **3.12. Junction Box Type A, B, or C**

Furnish: Junction box, No. 57 aggregate; grounding conductor

Excavate as required and place approximately 12 inches of No. 57 aggregate beneath the proposed junction box to allow for drainage. Install specified junction box type A, B, or C near the edge of pavement, flush with finished grade per the detail sheets. Where required, orient the box so that the dimensions comply with the National Electrical Code. Stub conduits with grounding bushings into junction box at its base to accommodate wires and connect grounding conductor to all grounding bushings. Backfill to existing grade, and restore disturbed area to the satisfaction of the Engineer.

Wiring inside box shall be neat and orderly. Label all wires and cables inside box.

### **3.13. Loops - Proposed**

Furnish: Wire; saw slot sealant; backer rod; grout; conduit sealant.

The plans and notes specify the approximate location for loop installations. Prior to sawing slots or drilling cores, the Contractor shall meet with a representative of the Division of Planning to verify the precise layout locations on site. Avoid expansion joints and pavement sections where potholes, cracks, or other roadway flaws exist.

Upon completion of this meeting, the Contractor shall measure out and mark the proposed loop locations with spray paint or chalk such that the saw slots will be parallel

and perpendicular to the direction of traffic. Marked lines shall be straight and exact to the locations determined and sized as shown on the plans. Unless indicated otherwise, loops shall be 6 feet by 6 feet square and loops in the same lane shall be spaced 16 feet from leading edge to leading edge.

On resurfacing, rehabilitation, and new construction projects that include new asphalt pavement, the Contractor shall install loops prior to laying the final surface course. On projects with milling and texturing, the Contractor may install the loops prior to or after the milling operation; however, if installed prior to milling, the Contractor shall be responsible for ensuring that the loops are installed at a depth such that the milling operation will not disturb the newly installed loops. The Contractor shall correct damage caused by the milling operations to newly installed loops prior to placement of the final surface course at no additional cost to the Cabinet.

For projects that include the installation of new asphalt and piezoelectric sensors, the Contractor shall mark or otherwise reference all loops installed prior to the final surface course such that the loops can be accurately located when the piezoelectric sensors are installed after placement of the final surface course.

For projects that do not have asphalt surfacing, the Contractor shall install the loops in the surface of the pavement.

The Prime Contractor shall coordinate the installation of loops with the electrical sub-Contractor and the Engineer to ensure correct operation of the completed installation.

The following is a typical step by step procedure for the installation of a loop.

- Carefully mark the slot to be cut, perpendicular to the flow of traffic and centered in the lane.
- Make each saw-cut 3/8-inch wide and at a depth such that the top of the backer rod is a minimum of 2 inches below the surface of rigid (PCC/Concrete) pavement or 4 inches below the surface of asphalt pavement.
- Drill a 1½ inch core hole at each corner and use a chisel to smooth corners to prevent sharp bends in the wire.
- Clean ALL foreign and loose matter out of the slots and drilled cores and within 1 foot on all sides of the slots using a high pressure washer.
- Completely dry the slots and drilled cores and within 1 foot on all sides of the slots using oil-free forced air, torpedo heaters, electric heaters, or natural evaporation, depending on weather conditions. Be very careful not to burn the asphalt if heat is used.
- Measure 9-12 inches from the edge of the paved surface (shoulder break or face of curb) and drill a 1½ inch hole on a 45° angle to the conduit adjacent to the roadway.
- Closely inspect all cuts, cores, and slots for jagged edges or protrusions prior to the placement of the wire. All jagged edges and protrusions shall be ground or re-cut and cleaned again.

- Place the loop wire splice-free from the termination point (cabinet or junction box) to the loop, continue around the loop for four turns, and return to the termination point.
- Push the wire into the saw slot with a blunt object such as a wooden stick. Make sure that the loop wire is pushed fully to the bottom of the saw slot.
- Install conduit sealant to a minimum of 1" deep into the cored 1½ inch hole.
- Apply loop sealant from the bottom up and fully encapsulate the loop wires in the saw slot. The wire should not be able to move when the sealant has set.
- Cover the encapsulated loop wire with a continuous layer of backer rod along the entire loop and home run saw slots such that no voids are present between the loop sealant and backer rod.
- Finish filling the saw cut with non-shrinkable grout per manufacturer's instructions. Alleviate all air pockets and refill low spaces. There shall be no concave portion to the grout in the saw slot. Any excess grout shall be cleaned from the roadway to alleviate tracking.
- Clean up the site and dispose of all waste off the project.
- Ensure that the grout has completely cured prior to subjecting the loop to traffic. Curing time varies with temperature and humidity.

Exceptions to installing loop wire splice-free to the junction box or cabinet may be considered on a case-by-case basis and must be pre-approved by the Engineer. If splices are allowed, they shall be located in a junction box and shall conform to the construction note for Splicing.

If loop lead-in cable (Cable No. 14/1 Pair) is specified, cable shall be installed splice free to the cabinet ensuring that extra cable is left in each junction box or cabinet. All wires and cables shall be labeled in each junction box and cabinet.

Loop inductance readings shall be between 100 and 300 microhenries. The difference of the loop inductance between two loops in the same lane shall be  $\pm 20$  microhenries. Inductance loop conductors shall test free of shorts and grounds. Upon completion of the project, all loops must pass an insulation resistance test of a minimum of 100 million ohms to ground when tested with a 500 Volt direct current potential in a reasonably dry atmosphere between conductors and ground.

### **3.14. Loops – Existing**

When noted on a data collection station layout sheet that there are existing inductive loops within the limits of the project, notify the Engineer in writing, a minimum of 14 calendar days prior to beginning milling operations. After milling and prior to placing asphalt inlay, conduct an operating test on the existing inductance loops at the control cabinet in the presence of the Engineer to determine if the inductance loop conductors have an insulating resistance of a minimum of 100 megohms when tested with a 500 volt direct current potential in a reasonably dry atmosphere between conductors and ground. The Department may also conduct its own tests with its own equipment.

If the tests indicate the loop resistances are above the specified limit and the Engineer determines the system is operable, proceed with the asphalt inlay. If the test indicates the loop resistance is not within the specified limits or if the Engineer determines the system is otherwise not operable, prior to placing the asphalt inlay install and test new loop detectors according to the station layout, notes, and Detail Drawings.

The Engineer will contact and maintain liaison with the District Planning Engineer and the Division of Planning in order to coordinate any necessary work.

### **3.15. Maintain and Control Traffic**

Furnish (all as required): Drums, traffic cones, barricades used for channelization purposes, delineators, and object markers.

Maintain and Control Traffic shall conform to the plans, the Standard Specifications for Road and Bridge Construction, and the KYTC Department of Highways Standard Drawings.

### **3.16. Open Cut Roadway**

Furnish: Concrete, reinforcing bars.

Excavate trench by sawing and chipping away roadway to dimensions as indicated on the detail sheets. After placing conduit, install concrete and steel reinforcing bars per the *Standard Specifications for Road and Bridge Construction*. Restore any disturbed sidewalk to its original condition.

### **3.17. Piezoelectric Sensor**

Furnish: Piezoelectric sensor and cable; sensor support brackets; saw slot sealant; backer rod; grout; conduit sealant.

The plans and notes specify the approximate location for piezoelectric sensor (piezo) installations. Prior to sawing slots or drilling cores, the Contractor shall meet with a representative of the Division of Planning to verify the final layout on site. Avoid expansion joints and pavement sections where potholes, cracks, or other roadway flaws exist. Roadway ruts at the proposed piezo location shall not be in excess of ½ inch under a 4-foot straight edge.

Install the piezo perpendicular to traffic in the final surface course of the pavement. Locate the sensor in the lane as shown on the site layout drawing. Eleven-foot length sensors shall be centered in the lane.

The following is a typical step by step procedure for the installation of a piezo. Refer specifically to the manufacturer's instructions provided with the sensor prior to installation.

- Carefully mark the slot to be cut, perpendicular to the flow of traffic and properly positioned in the lane.

- It is strongly recommended that a ¾ inch wide diamond blade be used for cutting the slot, or that blades be ganged together to provide a single ¾ inch wide cut. The slot shall be wet cut to minimize damage to the pavement.
- Cut a slot ¾ inch wide ( $\pm 1/16$  inch) by 1 inch minimum deep. The slot should be a minimum of 2 inches longer than the sensor (including the lead attachment). Drop the saw blade an extra ½ inch down on both ends of the sensor. The lead out of the passive cable should be centered on the slot.
- Cut the slot for the passive cable ¼ inch wide and at a depth so that the top of the backer rod is a minimum of 2 inches below the road surface.
- Clean ALL foreign and loose matter out of the slot and within 1 foot on all sides of the slot using a high pressure washer.
- Completely dry the slot and within 1 foot on all sides of the slot using oil-free forced air, torpedo heaters, electric heaters, or natural evaporation, depending on weather conditions. Be very careful not to burn the asphalt if heat is used.
- Measure 9-12 inches from the edge of the paved surface (shoulder break or face of curb) and drill a 1½ inch hole on a 45° angle to the conduit adjacent to the roadway.
- Place strips of 2-4 inch wide tape strips on the pavement along the lengths of both sides of the sensor slot, 1/8 inch away from the slot.
- Wear clean, protective latex (or equivalent) gloves at all times when handling sensors. Visually inspect sensor to ensure it is straight. Check lead attachment and passive cable for cuts, gaps, cracks and/or bare wire. Verify that the correct sensor type and length is being installed by checking the data sheet. Verify there is sufficient cable to reach the cabinet. Piezo lead-in cable shall not be spliced.
- Test the sensor for capacitance, dissipation factor and resistance, according to the directions enclosed with the sensor. Capacitance and dissipation should be within  $\pm 20\%$  of the piezo data sheet. Resistance (using the 20M setting) should be infinite. Record the sensor serial number and the test results and label "pre-installation." This information should be stored in the counter cabinet and/or returned to Department Planning personnel.
- Lay the sensor next to the slot and ensure that it is straight and flat.
- Clean the sensor with steel wool or an emery pad and wipe with alcohol and a clean, lint-free cloth.
- Place the installation bracket clips every 6 inches along the length of the sensor.
- Bend the tip of the sensor downward at a 30° angle. Bend the lead attachment end down at a 15° angle and then 15° back up until level (forming a lazy Z).
- Place the sensor in the slot, with the brass element 3/8 inch below the road surface along the entire length. The tip of the sensor should be a minimum of 2 inches from the end of the slot and should not touch the bottom of the slot. The top of the plastic installation bracket clips should be 1/8 inch below the surface of the road. The lead attachment should not touch the bottom or sides of the slot. Ensure the sensor ends are pushed down per the manufacturer's instructions.
- Visually inspect the length of the sensor to ensure it is at uniform depth along its length and it is level (not twisted, canted or bent).

Material, Installation, and Bid Item Notes for  
Permanent Traffic Data Acquisition Stations

Revised August, 2018

- On the passive cable end, block the end of the slot approximately 3-5 inches beyond the end of the lead attachment area creating an adequate “dam” so that the sensor grout does not flow out.
- Use one bucket of sensor grout per piezo installation. Overfill the slot with sensor grout and allow to cure for a minimum of 10 minutes before continuing with the installation. Ensure that sensor grout fills around and beneath the sensor completely and that there is not a trough on top.
- Remove the tape along the sides of the saw slot when the adhesive starts to cure.
- Carefully remove the dam from the end of the sensor.
- Route the lead-in cable through the saw slot
- Install conduit sealant to a minimum of 1” deep into the cored 1½ inch hole.
- Cover the lead-in cable with encapsulant, backer rod, and grout.
- If necessary, after the grout has hardened, grind with an angle grinder until the profile is a 1/16 inch mound. There shall be no concave portion to the mound.
- Clean up the site and dispose of all waste off the project.
- Ensure that the sensor grout has completely cured prior to subjecting the sensor to traffic. Curing time will vary with temperature and humidity.

Upon installation, test the sensor for capacitance, dissipation factor and resistance, according to the directions enclosed with the sensor. Capacitance and dissipation should be within  $\pm 20\%$  of the piezo data sheet. Resistance (using the 20M setting) should be infinite. Perform a functional test of the piezo with an oscilloscope to ensure that the sensor is generating a proper response to the passage of vehicles.

Record the sensor serial number and the test results and label “post-installation.” This information should be stored in the counter cabinet and/or returned to Department Planning personnel.

### **3.18. Pole – Wooden**

Furnish: Pole; anchoring equipment (as required); hardware (as required).

Excavate and install wood pole to a minimum depth of one-sixth the total pole height. Place backfill material in hole and compact until flush with existing grade. Install guy wire, guy guard, anchor, anchor rod, and strand vise, if necessary. Anchor shall be a minimum of one-third the pole height from the face of the pole. Provide temporary erosion control, seeding, protection and restoration of disturbed areas to the satisfaction of the Engineer.

### **3.19. Removal of Existing Equipment**

The Contractor shall remove existing materials (including but not limited to: poles, anchors, cabinets, junction boxes, conduit and wire) not to be reused. Contractor shall dispose of all removed materials off the project. All materials and labor necessary for the removal of existing equipment shall be considered incidental to other bid items.

### **3.20. Signs**

Furnish: Signs; sign standards; hardware.

Construction of signs shall conform to the *Standard Specifications for Road and Bridge Construction*.

### **3.21. Splicing**

Furnish: Splice kit; solder.

These notes describe the splicing process (if permitted) and are not intended to grant permission to splice. Permission to splice shall be determined by the Division of Planning and the locations shall be shown on the layout sheet. If splicing is needed but not shown on the layout sheet, the Contractor shall receive prior written approval from the Division of Planning.

All splices shall conform to the provisions of the NEC.

Splices for loop and loop lead-in wire shall be twisted and soldered. Abrade the outer jacket of both wires to promote good adhesion and prevent capillary leak paths. Seal the splice with an electrical sealing resin. Spliced loop conductors shall test free of shorts and unauthorized grounds and shall have an insulating resistance of at least 100 megohms when tested with a 500 volt direct current potential in a reasonably dry atmosphere between conductors and ground.

For piezos, the same type coax cable, supplied by the manufacturer, shall be used to splice to the sensor's lead-in cable. Cables shall be soldered. Abrade the outer jacket of both cables to promote good adhesion and prevent capillary leak paths. Seal the splice with an electrical sealing resin. Spliced piezo cables shall be tested and have a minimum resistance of 20 megohms, a maximum dissipation factor of 0.03, a capacitance within the manufacturer's recommended range based upon the length of additional cable. A functional test of the piezo shall be performed to ensure that the sensor is generating a proper response to the passage of vehicles.

### **3.22. Trenching and Backfilling**

Furnish: Warning tape; seed mix type I; cereal rye or German foxtail-millet; mulch; concrete (as required); asphalt (as required).

Excavate trench and provide required cover as shown on the standard detail sheets. After placing conduit, backfill material shall be placed and compacted in lifts of 9 inches or less. Install warning tape as shown on the detail sheet. Provide temporary erosion control, seeding, protection and restoration of disturbed areas to the satisfaction of the Engineer. This item shall include concrete, asphalt or approved replacement material for sidewalks, curbs, roadways, etc. (if required).

### **3.23. Wiring**

Furnish: Wire; wire labels; spade tongue wire terminals (as required).

Installation of all wiring shall conform to the NEC. Permanent identification numbers shall be affixed to all wires in all junction boxes and cabinets (see Layout(s) for loop and piezo numbers).

Additional lengths of each loop and piezo sensor wire shall be neatly coiled in all cabinets and junction boxes as follows:

<u>Enclosure Type</u>	<u>Additional length of each wire</u>
Galvanized Steel Cabinet	2' - 3'
Pad Mount Cabinet (332)	6' - 8'
Pole Mount Cabinet (336)	3' - 4'
Junction Box Type 10x8x4	2' - 3'
Junction Box Type A, B, or C	2' - 3'

**3.24. Wood Post**

Furnish: Wood post; concrete (as required); seed mix type I; cereal rye or German foxtail-millet; mulch.

Excavate hole to specified depth and place concrete, if required. Install post, backfill to existing grade, and tamp backfill. Provide temporary erosion control, seeding, protection and restoration of disturbed areas to the satisfaction of the Engineer.

#### **4. BID ITEM NOTES AND METHOD OF MEASUREMENT FOR PAYMENT**

Only the bid items listed will be measured for payment. All other items required to complete the vehicle detection installation shall be incidental to other items of work. Payment at the contract unit price shall be full compensation for all materials, labor, equipment and incidentals to furnish and install these items.

##### **4.1. Bore and Jack Pipe – 2”**

Bore and jack pipe – 2” shall be furnished, installed, and measured for payment per the *Standard Specifications for Road and Bridge Construction*.

##### **4.2. Conduit**

Conduit shall include furnishing and installing specified conduit in accordance with the specifications. This item shall include conduit fittings, bodies, boxes, weatherheads, expansion joints, couplings, caps, conduit sealant, electrical tape, clamps, bonding straps and any other necessary hardware. Conduit will be measured in linear feet.

##### **4.3. Electrical Service**

Electrical Service shall include furnishing and installing all necessary materials and payment of all fees toward the complete installation of an electrical service which has passed all required inspections. Incidental to this item shall be furnishing and installing:

- Meter-base per utility company’s specifications
- Service disconnect panel per utility company’s specifications
- Meter base and service disconnect entrance hubs, waterproof
- Service entrance conductors
- Rigid steel conduit
- Rigid steel conduit fittings
- Conduit straps
- Weatherhead
- Duplex GFCI receptacle, 120-volt, 20-amp
- Ground rod with clamp
- Grounding conductor

Also incidental to this item shall be any necessary clearing of right of way for the electrical service drop.

Electrical service will be measured in individual units each.

##### **4.4. Flashing Arrow**

Flashing Arrow shall be furnished, installed, and measured for payment per the *Standard Specifications for Road and Bridge Construction*.

##### **4.5. Galvanized Steel Cabinet**

Galvanized Steel Cabinet shall include furnishing and installing galvanized steel cabinet on post as specified. Incidental to this item shall be furnishing and installing grounding hardware, and any necessary post/pole mounting hardware. Also incidental to this item shall be furnishing and installing the required number of terminal blocks and connection of all

sensors to the terminal blocks. Galvanized Steel Cabinet will be measured in individual units each.

#### **4.6. Install Pad Mount Enclosure**

Install Pad Mount Enclosure shall include installing a Department-furnished enclosure as specified on the detail sheets.

This item shall include obtaining the enclosure from KYTC and transporting it to the installation site and furnishing and installing the following:

- Concrete foundation (including any excavation necessary)
- Anchor bolts, lock washers, and nuts
- Conduit
- Conduit fittings (including grounding bushings)
- Weatherhead
- Terminal Strip(s)
- Ground rod with clamp
- Grounding conductor

Install Pad Mount Enclosure will be measured in individual units each.

#### **4.7. Install Controller Cabinet**

Install Controller Cabinet shall include installing a Department-furnished cabinet as specified on the detail sheets.

This item shall include obtaining the cabinet from KYTC and transporting it to the installation site and furnishing and installing the following:

- Conduit
- Conduit Fittings
- Terminal Strip(s)
- Ground rod with clamp
- Grounding conductor

Install Controller Cabinet will be measured in individual units each.

#### **4.8. Junction Box Type 10" x 8" x 4"**

Junction Box Type 10"x8"x4" shall include furnishing and installing specified junction box in accordance with the specifications. This item shall include connectors, splice sleeves, conduit fittings, mounting materials and any other items required to complete the installation. Incidental to this item shall be furnishing and installing specified post (wood, channel, metal, etc.) as required for the installation. Junction Box Type 10"x8"x4" will be measured in individual units each.

#### **4.9. Junction Box Type A, B, or C**

Junction Box Type A, B, or C shall include furnishing and installing specified junction box in accordance with the specifications. This item shall include excavation, furnishing and installing #57 aggregate, backfilling around the box, and restoration of disturbed areas to the satisfaction of the Engineer. Incidental to this item shall be furnishing and installing a

grounding conductor bonding all conduit grounding bushings in the box. Junction Box Type A, B, or C will be measured in individual units each.

**4.10. Loop Saw Slot and Fill**

Loop Saw Slot and Fill shall include sawing and cleaning saw slots and furnishing and installing conduit sealant, loop sealant, backer rod, grout, or other specified material. Loop Saw Slot and Fill will be measured in linear feet of sawed slot.

**4.11. Maintain and Control Traffic**

Maintain and Control Traffic shall be measured for payment per the *Standard Specifications for Road and Bridge Construction*.

**4.12. Open Cut Roadway**

Open Cut Roadway shall include excavating trench (sawing and chipping roadway) to dimensions as indicated on the detail sheets and furnishing and placing concrete, steel reinforcing bars, and asphalt. This item also includes restoring any disturbed sidewalk to its original condition. Open Cut Roadway will be measured in linear feet.

**4.13. Piezoelectric Sensor**

Piezoelectric sensor (piezo) shall include sawing and cleaning saw slots and furnishing and installing piezo in accordance with the specifications. This item shall include furnishing and installing lead-in wire, conduit sealant, encapsulation material, backer rod, grout, testing, and accessories. Piezo will be measured in individual units each.

**4.14. Pole – 35' Wooden**

Pole – 35' Wooden shall include excavation, furnishing and installing specified wood pole, backfilling and restoring disturbed areas to the satisfaction of the Engineer. Incidental to this item shall be furnishing and installing guy wire, anchor and anchor rod, strand vise, and guy guard, if specified.

Pole – 35' Wooden will be measured in individual units each.

**4.15. Signs**

Signs shall be furnished, installed, and measured for payment per the *Standard Specifications for Road and Bridge Construction*.

**4.16. Trenching and Backfilling**

Trenching and Backfilling shall include excavation, warning tape, backfilling, temporary erosion control, seeding, protection and restoration of disturbed areas to original condition. This item shall include concrete, asphalt or approved replacement material for sidewalks, curbs, roadways, etc. (if required). Trenching and backfilling will be measured in linear feet.

**4.17. Wire or Cable**

Wire or cable shall include furnishing and installing specified wire or cable within saw slot, conduit, junction box, cabinet, or overhead as indicated on the detail sheets. Incidental to this item shall be the labeling of all wires and cables in each junction box, cabinet and splice

Material, Installation, and Bid Item Notes for  
Permanent Traffic Data Acquisition Stations

Revised August, 2018

box, and furnishing and installing other hardware required for installing cable. Wire or Cable will be measured in linear feet.

**4.18. Wood Post**

Wood Post shall include furnishing and installing wood post as specified. This item shall include excavation, furnishing and placing concrete (if required), backfilling around the post, and restoration of disturbed areas to the satisfaction of the engineer. Wood Post will be measured in individual units each.

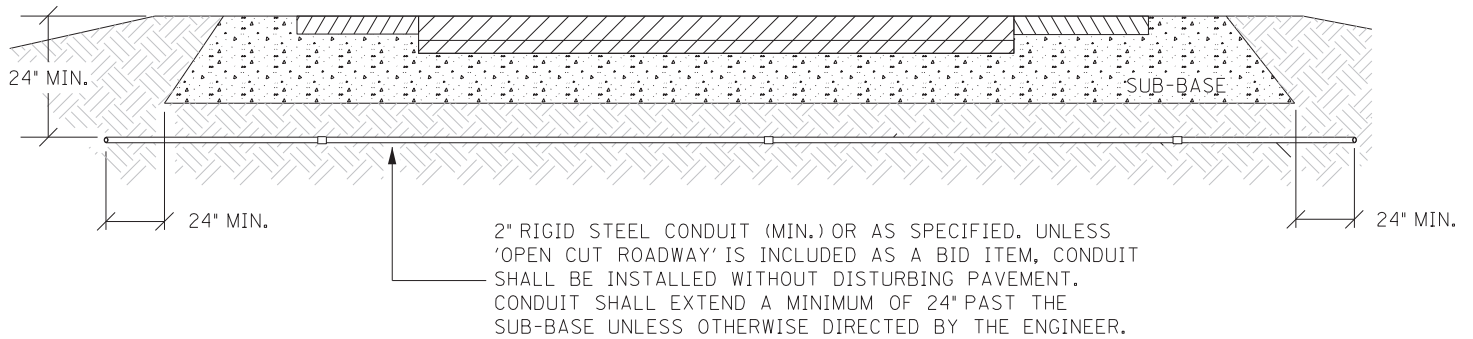

CONDUIT UNDER PAVEMENT

TOTAL TRENCH WIDTH SHALL BE 3" (NOM.) WIDER THAN THE SUM OF THE OUTSIDE DIAMETER(S) OF THE CONDUIT(S) INSTALLED. CONDUIT(S) SHALL BE CENTERED IN TRENCH.

CONTRACTOR SHALL PLACE BACKFILL IN LIFTS (9" MAX.) COMPACT BACKFILL, AND RESTORE DISTURBED AREA TO THE SATISFACTION OF THE ENGINEER

CONTRACTOR SHALL INSTALL UNDERGROUND UTILITY WARNING TAPE ABOVE CONDUIT AS SHOWN.

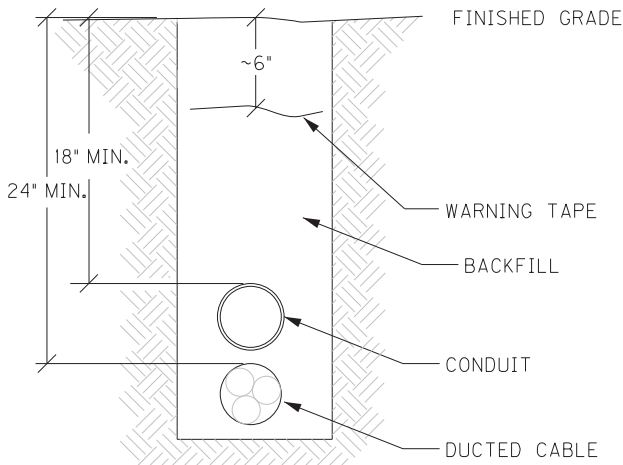

CONDUIT TRENCH

#4 BARS @ 8" O.C.  
EACH WAY

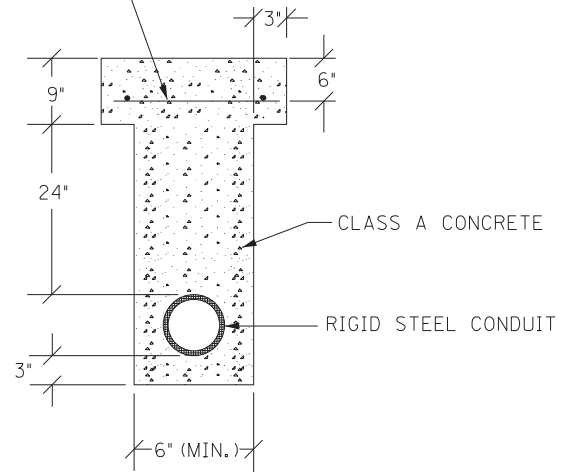

OPEN CUT PAVEMENT DETAIL

CONDUIT INSTALLATION

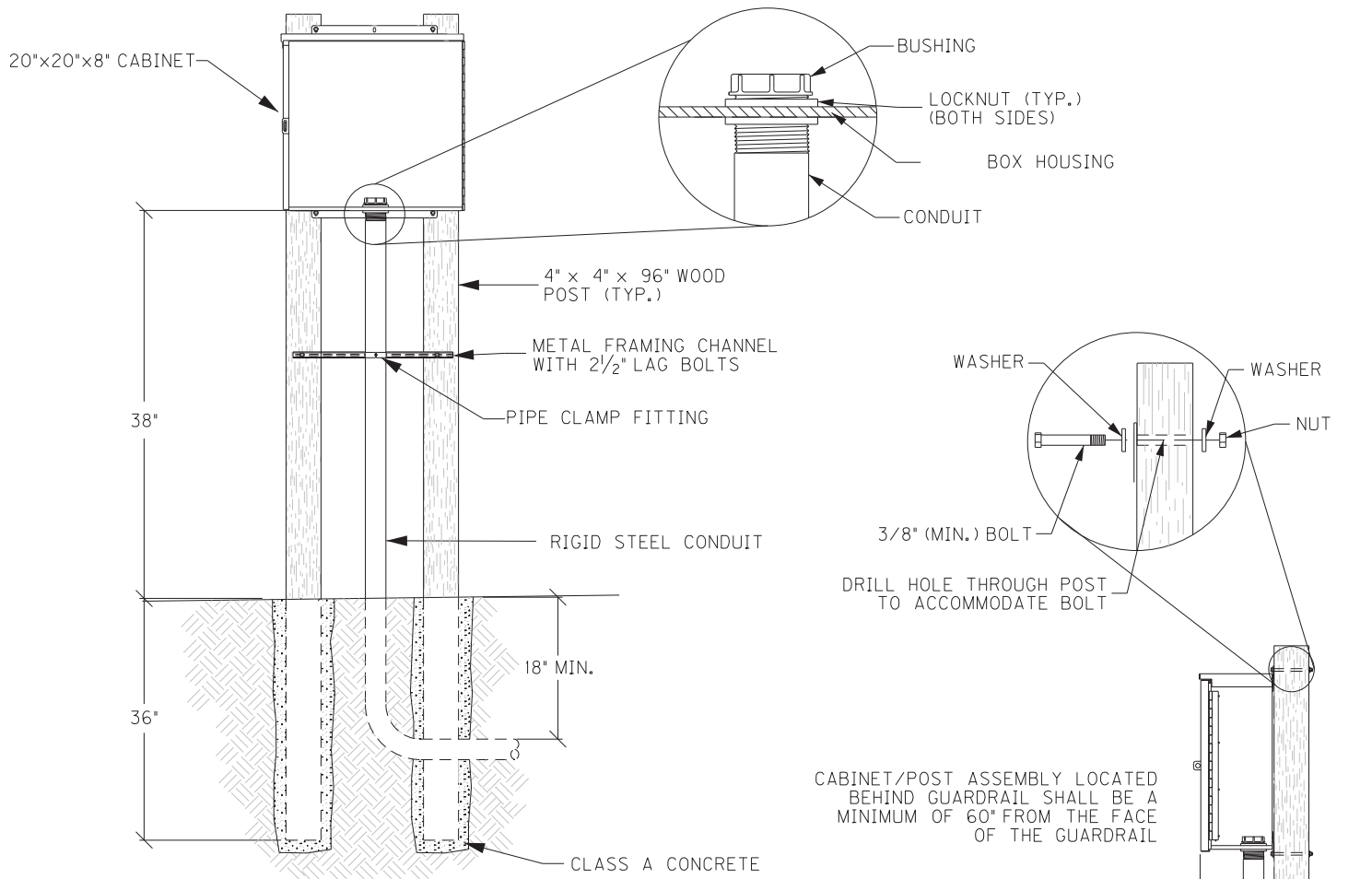

FRONT VIEW

CABINET/POST ASSEMBLY LOCATED BEHIND GUARDRAIL SHALL BE A MINIMUM OF 60" FROM THE FACE OF THE GUARDRAIL

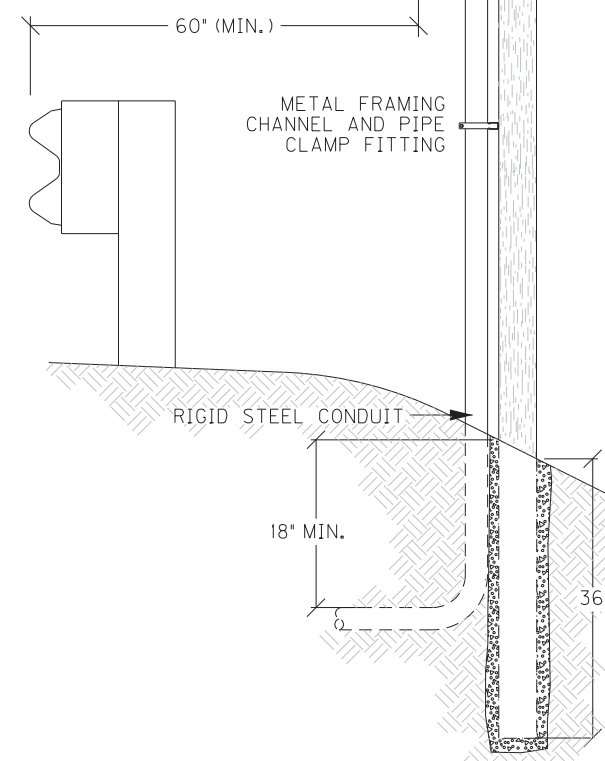

RIGHT VIEW

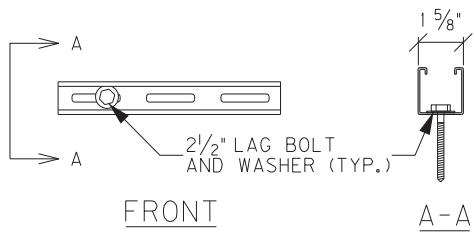

METAL FRAMING CHANNEL

GALVANIZED STEEL CABINET  
DOUBLE POST ASSEMBLY

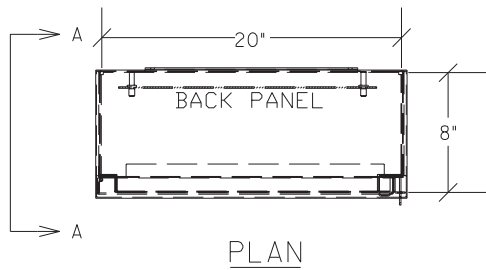

PLAN

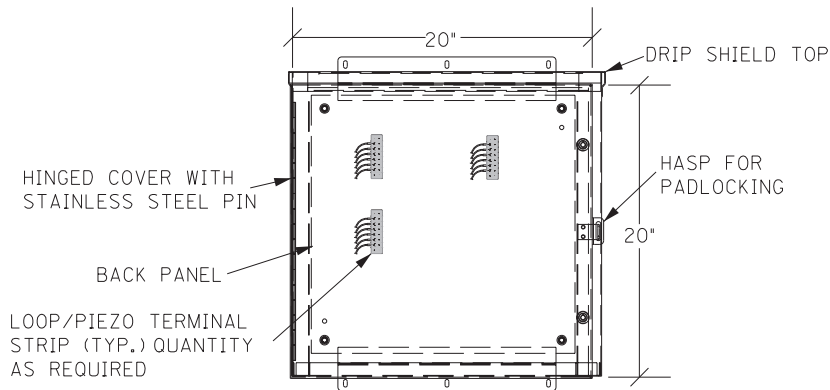

ELEVATION

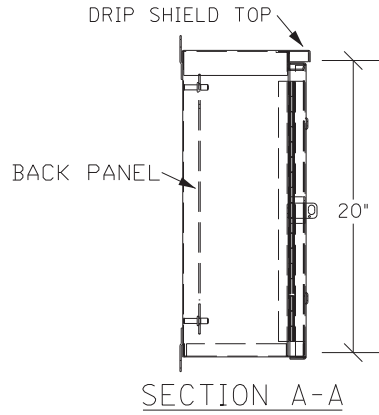

SECTION A-A

GALVANIZED STEEL CABINET

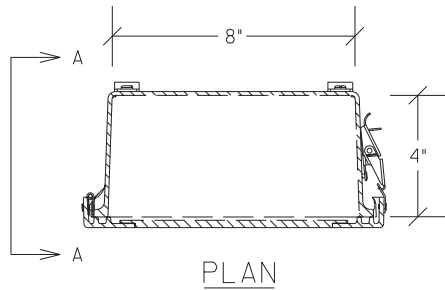

PLAN

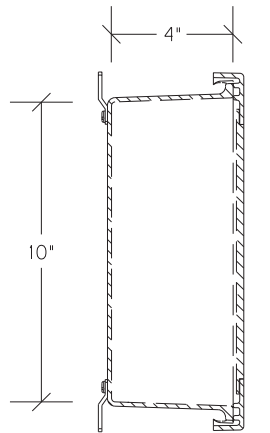

SECTION A-A

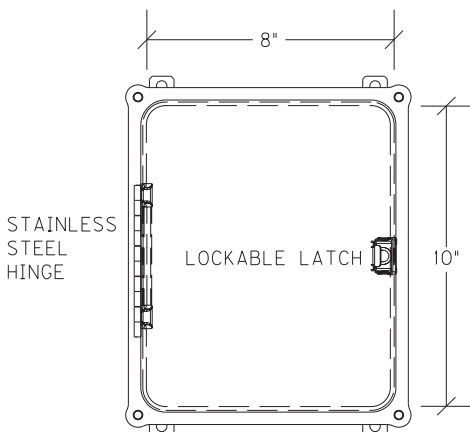

ELEVATION

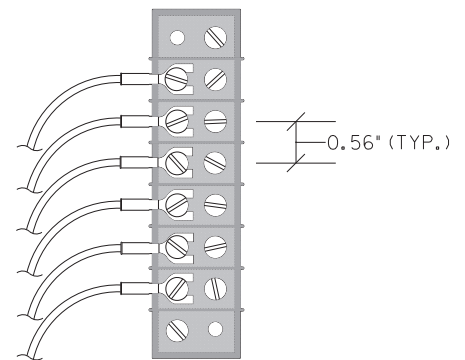

TERMINAL STRIP (TYP.)

JUNCTION BOX 10"X8"X4"

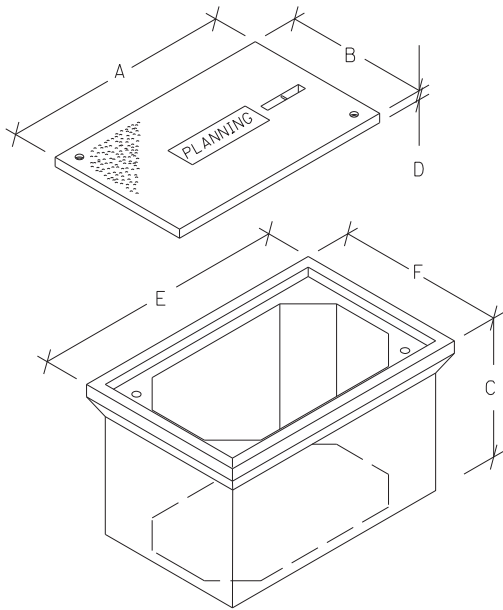

JUNCTION BOX DIMENSIONS (NOMINAL)						
	A	B	C	D*	E	F
TYPE A	23"	14"	18"	2"	25"	16"
TYPE B	18"	11"	12"	1¾"	20"	13"
TYPE C	36"	24"	30"	3"	38"	26"

\* MINIMUM  
STACKABLE BOXES ARE PERMITTED

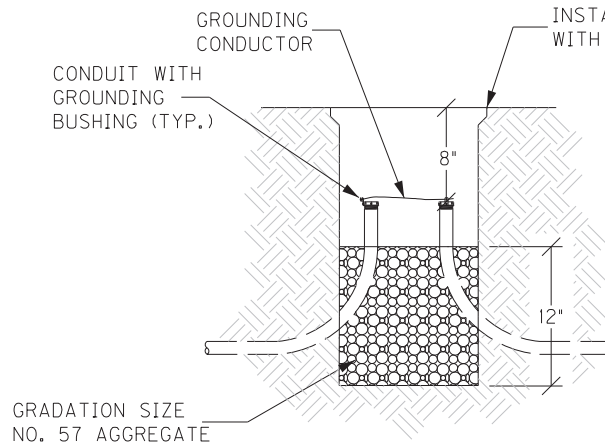

WHERE REQUIRED, JUNCTION BOX SHALL BE ORIENTED SUCH THAT THE DIMENSIONS COMPLY WITH THE NATIONAL ELECTRICAL CODE.

ELEVATION

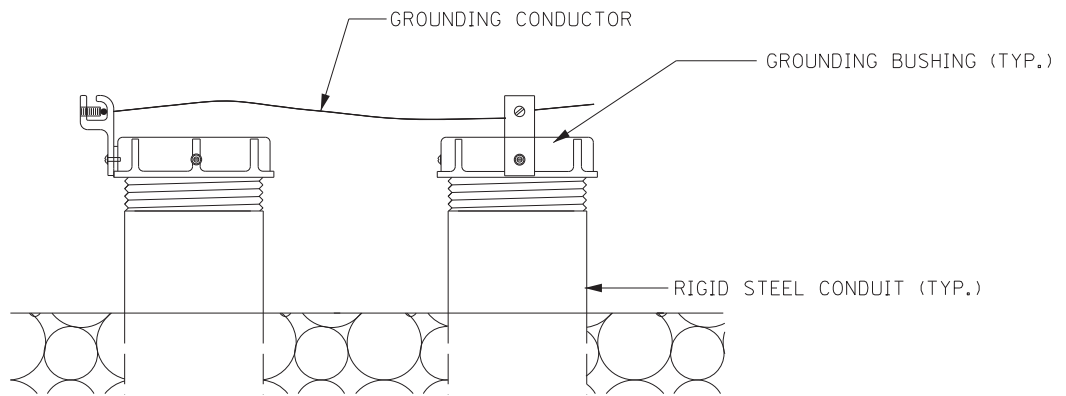

GROUNDING DETAIL

JUNCTION BOX - TYPE A, TYPE B, TYPE C

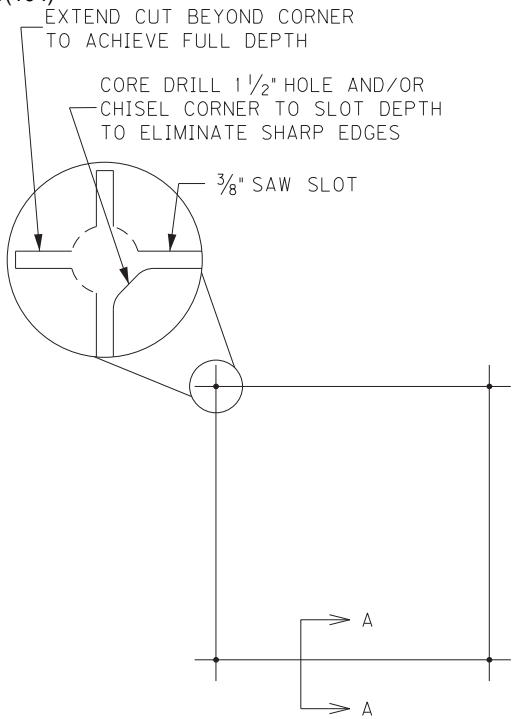

SAW CUT PLAN

UNLESS SPECIFIED OTHERWISE, ALL LOOPS SHALL BE 6' x 6' SQUARE, CENTERED IN EACH LANE, WITH FOUR TURNS OF 14 AWG LOOP WIRE.

ADJACENT SAW SLOTS SHALL BE A MINIMUM OF 12" APART.

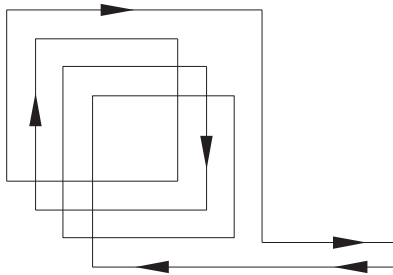

WIRING PLAN

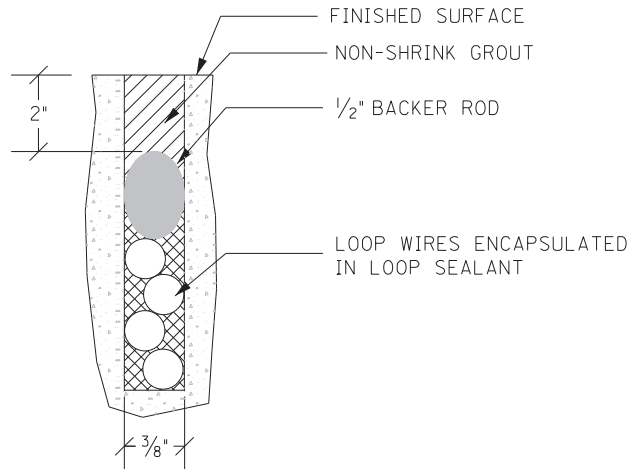

SECTION A-A (CONCRETE)

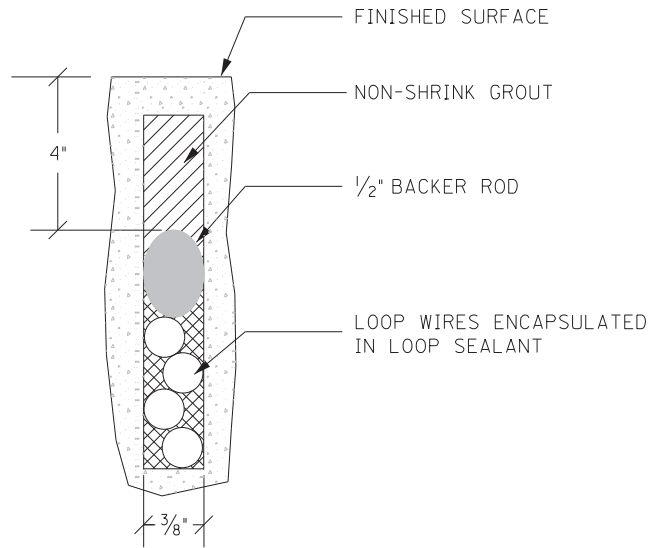

SECTION A-A (ASPHALT)

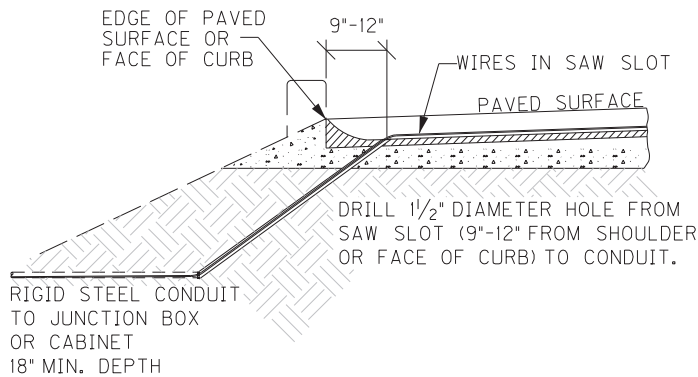

SAW SLOT EDGE OF PAVEMENT TRANSITION

INDUCTIVE LOOP DETECTOR

EXTEND SAW SLOT A MINIMUM OF 2" BEYOND THE END OF THE SENSOR.

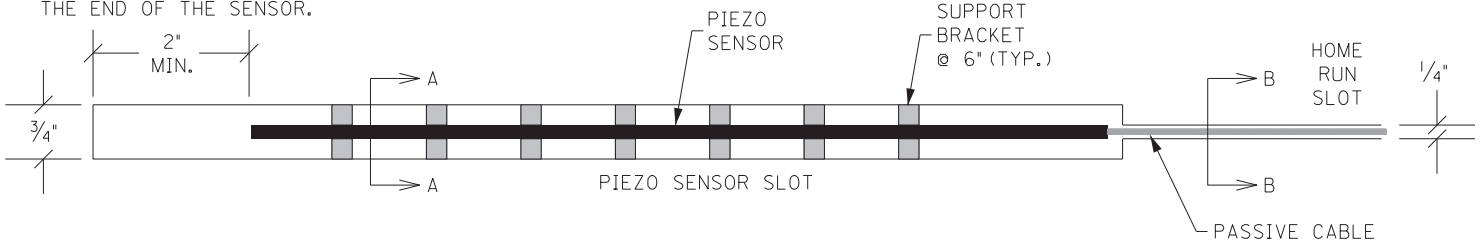

PLAN

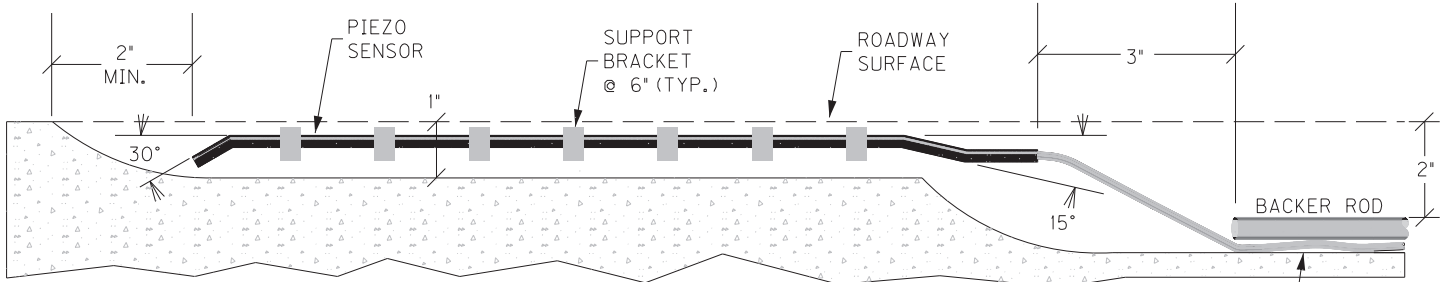

ELEVATION

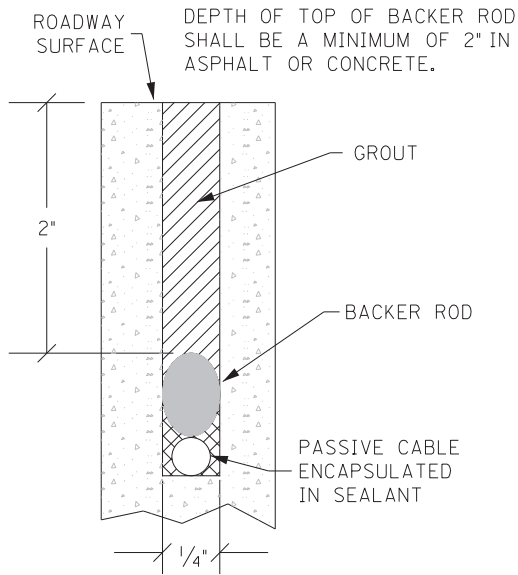

SECTION B-B

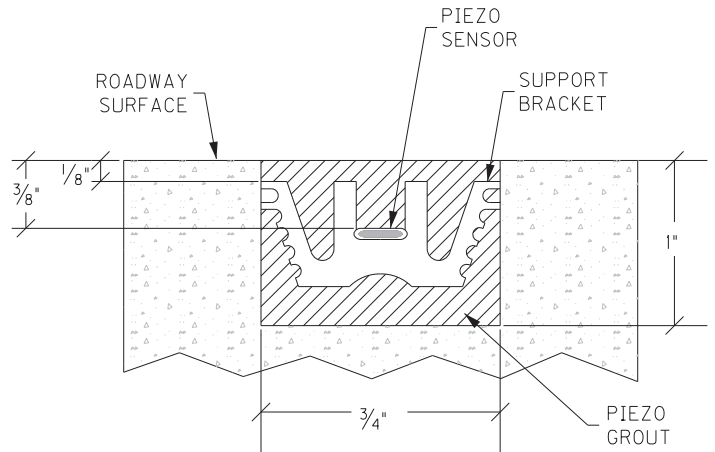

SECTION A-A

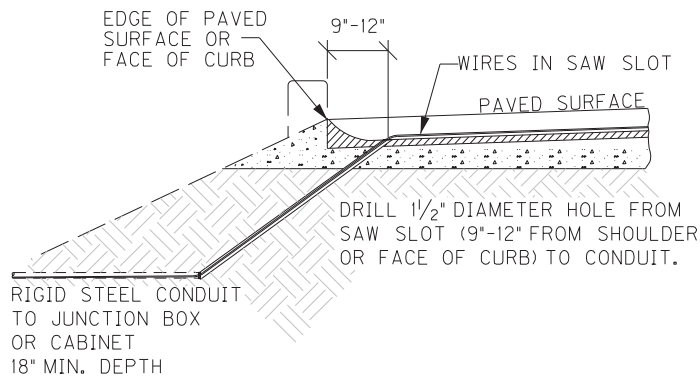

SAW SLOT EDGE OF PAVEMENT TRANSITION

PIEZOELECTRIC SENSOR INSTALLATION

	KENTUCKY TRANSPORTATION CABINET Department of Highways DIVISION OF RIGHT OF WAY & UTILITIES  <b>RIGHT OF WAY CERTIFICATION</b>	TC 62-226 Rev. 01/2016 Page 1 of 1
---	--	--

<input checked="" type="checkbox"/> Original	<input type="checkbox"/> Re-Certification	<b>RIGHT OF WAY CERTIFICATION</b>	
ITEM #	COUNTY	PROJECT # (STATE)	PROJECT # (FEDERAL)
3-20016.00	Warren	FD52 114 0065 013-026	NHPP 0651(104)

**PROJECT DESCRIPTION**

RESURFACING ON I 65 FROM MP 13.7 – 25.2

**No Additional Right of Way Required**

Construction will be within the limits of the existing right of way. The right of way was acquired in accordance to FHWA regulations under the Uniform Relocation Assistance and Real Property Acquisitions Policy Act of 1970, as amended. No additional right of way or relocation assistance were required for this project.

**Condition # 1 (Additional Right of Way Required and Cleared)**

All necessary right of way, including control of access rights when applicable, have been acquired including legal and physical possession. Trial or appeal of cases may be pending in court but legal possession has been obtained. There may be some improvements remaining on the right-of-way, but all occupants have vacated the lands and improvements, and KYTC has physical possession and the rights to remove, salvage, or demolish all improvements and enter on all land. Just Compensation has been paid or deposited with the court. All relocations have been relocated to decent, safe, and sanitary housing or that KYTC has made available to displaced persons adequate replacement housing in accordance with the provisions of the current FHWA directive.

**Condition # 2 (Additional Right of Way Required with Exception)**



The right of way has not been fully acquired, the right to occupy and to use all rights-of-way required for the proper execution of the project has been acquired. Some parcels may be pending in court and on other parcels full legal possession has not been obtained, but right of entry has been obtained, the occupants of all lands and improvements have vacated, and KYTC has physical possession and right to remove, salvage, or demolish all improvements. Just Compensation has been paid or deposited with the court for most parcels. Just Compensation for all pending parcels will be paid or deposited with the court prior to AWARD of construction contract

**Condition # 3 (Additional Right of Way Required with Exception)**

The acquisition or right of occupancy and use of a few remaining parcels are not complete and/or some parcels still have occupants. All remaining occupants have had replacement housing made available to them in accordance with 49 CFR 24.204. KYTC is hereby requesting authorization to advertise this project for bids and to proceed with bid letting even though the necessary right of way will not be fully acquired, and/or some occupants will not be relocated, and/or the just compensation will not be paid or deposited with the court for some parcels until after bid letting. KYTC will fully meet all the requirements outlined in 23 CFR 635.309(c)(3) and 49 CFR 24.102(j) and will expedite completion of all acquisitions, relocations, and full payments after bid letting and prior to AWARD of the construction contract or force account construction.

Total Number of Parcels on Project	EXCEPTION (S) Parcel #	ANTICIPATED DATE OF POSSESSION WITH EXPLANATION
<b>Number of Parcels That Have Been Acquired</b>		
Signed Deed		
Condemnation		
Signed ROE		

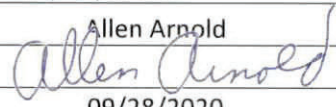
**Notes/ Comments (Use Additional Sheet if necessary)**

<b>LPA RW Project Manager</b>		<b>Right of Way Supervisor</b>	
Printed Name		Printed Name	Allen Arnold
Signature		Signature	
Date		Date	09/28/2020
<b>Right of Way Director</b>		<b>FHWA</b>	
Printed Name		Printed Name	No Signature Required
Signature		Signature	as per FHWA-KYTC
Date	2020.09.28 10:49:51 -05'00'	Date	Current Stewardship Agreement

## UTILITIES AND RAIL CERTIFICATION NOTE

**COUNTY: WARREN**  
**PROJECT ID NUMBER: FD52 114 0065 019-026**  
**FEDERAL NUMBER: NHPP 0651 (104)**  
**TYPE OF PROJECT: RESTORATION & REHAB**  
**ROUTE NUMBER, FACILITY NAME: I-65, LOUISVILLE - NASHVILLE ROAD**  
**SCOPE OF PROJECT: ADDRESS PAVEMENT CONDITION OF I-65 BOTH DIRECTION(S)**  
**FROM MILEPOINT 19.6 TO MILEPOINT 25.2**  
**6 YRP ITEM NUMBER: 03-20016.00**

### PROJECT NOTES ON UTILITIES

For all projects under 2000 Linear feet which require a normal excavation locate request pursuant to KRS 367.4901-4917, the awarded contractor shall field mark the proposed excavation or construction boundaries of the project (also called white lining) using the procedure set forth in KRS 367.4909(9)(k). For all projects over 2000 linear feet, which are defined as a "Large Project" in KRS 367.4903(18), the awarded contractor shall initially mark the first 2000 linear feet minimally of proposed excavation or construction boundaries of the project to be worked using the procedure set forth in KRS 367.4909(9)(k). This temporary field locating of the project excavation boundary shall take place prior to submitting an excavation location request to the underground utility protection Kentucky Contact Center. For large projects, the awarded contractor shall work with the impacted utilities to determine when additional white lining of the remainder of the project site will take place. This provision shall not alter or relieve the awarded contractor from complying with requirements of KRS 367.4905 to 367.4917 in their entirety.

Please Note: The information presented in this Utility Note is informational in nature and the information contained herein is not guaranteed.

The contractor will be responsible for contacting all utility facility owners on the subject project to coordinate his activities. The contractor will coordinate his activities to minimize and, where possible, avoid conflicts with utility facilities. Due to the nature of the work proposed, it is unlikely to conflict with the existing utilities beyond minor facility adjustments. Where conflicts with utility facilities are unavoidable, the contractor will coordinate any necessary relocation work with the facility owner and Resident Engineer. The Kentucky Transportation Cabinet maintains the right to remove or alter portions of this contract if a utility conflict occurs. The utility facilities as noted in the previous section(s) have been determined using data garnered by varied means and with varying degrees of accuracy: from the facility owners, a result of S.U.E., field inspections, and/or reviews of record drawings. The facilities defined may not be inclusive of all utilities in the project scope and are not Level A quality, unless specified as such. It is the contractor's responsibility to verify all utilities and their respective locations before excavating.

## UTILITIES AND RAIL CERTIFICATION NOTE

**COUNTY: WARREN**  
**PROJECT ID NUMBER: FD52 114 0065 019-026**  
**FEDERAL NUMBER: NHPP 0651 (104)**  
**TYPE OF PROJECT: RESTORATION & REHAB**  
**ROUTE NUMBER, FACILITY NAME: I-65, LOUISVILLE - NASHVILLE ROAD**  
**SCOPE OF PROJECT: ADDRESS PAVEMENT CONDITION OF I-65 BOTH DIRECTION(S)**  
**FROM MILEPOINT 19.6 TO MILEPOINT 25.2**  
**6 YRP ITEM NUMBER: 03-20016.00**

The contractor shall make every effort to protect underground facilities from damage as prescribed in the Underground Facility Damage Protection Act of 1994, Kentucky Revised Statute KRS 367.4901 to 367.4917. It is the contractor's responsibility to determine and take steps necessary to be in compliance with federal and state damage prevention directives. The contractor is instructed to contact KY 811 for the location of existing underground utilities. Contact shall be made a minimum of two (2) and no more than ten (10) business days prior to excavation. The contractor shall submit Excavation Locate Requests to the Kentucky Contact Center (KY 811) via web ticket entry. The submission of this request does not relieve the contractor from the responsibility of contacting non-member facility owners, whom are to be contacted through their individual Protection Notification Center. It may be necessary for the contractor to contact the County Court Clerk to determine what utility companies have facilities in the area. Non-compliance with these directives can result in the enforcement of penalties.

Utility coordination efforts determined that no significant utility relocation work is required to complete the project. Any work pertaining to these utility facilities is defined in the bid package and is to be carried out as instructed by the Kentucky Transportation Cabinet. The contractor will be responsible for any coordination or adjustments that are discussed or quantified in the proposal.

## UTILITIES AND RAIL CERTIFICATION NOTE

**COUNTY: WARREN**  
**PROJECT ID NUMBER: FD52 114 0065 019-026**  
**FEDERAL NUMBER: NHPP 0651 (104)**  
**TYPE OF PROJECT: RESTORATION & REHAB**  
**ROUTE NUMBER, FACILITY NAME: I-65, LOUISVILLE - NASHVILLE ROAD**  
**SCOPE OF PROJECT: ADDRESS PAVEMENT CONDITION OF I-65 BOTH DIRECTION(S)**  
**FROM MILEPOINT 19.6 TO MILEPOINT 25.2**  
**6 YRP ITEM NUMBER: 03-20016.00**

**NOTE: DO NOT DISTURB THE FOLLOWING FACILITIES LOCATED WITHIN THE PROJECT DISTURB LIMITS**

\*The Contractor is fully responsible for protection of all utilities \*

**THE FOLLOWING FACILITY OWNERS ARE RELOCATING/ADJUSTING THEIR FACILITIES WITHIN THE PROJECT LIMITS AND WILL BE COMPLETE PRIOR TO CONSTRUCTION**

Not Applicable

**THE FOLLOWING FACILITY OWNERS HAVE FACILITIES TO BE RELOCATED/ADJUSTED BY THE OWNER OR THEIR SUBCONTRACTOR AND IS TO BE COORDINATED WITH THE ROAD CONTRACT**

Not Applicable

**THE FOLLOWING FACILITY OWNERS HAVE FACILITIES TO BE RELOCATED/ADJUSTED BY THE ROAD CONTRACTOR AS INCLUDED IN THIS CONTRACT**

Not Applicable

**RAIL COMPANIES HAVE FACILITIES IN CONJUNCTION WITH THIS PROJECT AS NOTED**

No Rail Involvement  
  Rail Involved  
  Rail Adjacent

## UTILITIES AND RAIL CERTIFICATION NOTE

**COUNTY: WARREN**  
**PROJECT ID NUMBER: FD52 114 0065 019-026**  
**FEDERAL NUMBER: NHPP 0651 (104)**  
**TYPE OF PROJECT: RESTORATION & REHAB**  
**ROUTE NUMBER, FACILITY NAME: I-65, LOUISVILLE - NASHVILLE ROAD**  
**SCOPE OF PROJECT: ADDRESS PAVEMENT CONDITION OF I-65 BOTH DIRECTION(S)**  
**FROM MILEPOINT 19.6 TO MILEPOINT 25.2**  
**6 YRP ITEM NUMBER: 03-20016.00**

### AREA FACILITY OWNER CONTACT LIST

Facility Owner	Address	Contact Name	Phone	Email
Bowling Green Municipal Utilities - Electric	P.O. Box 10300 Bowling Green, KY 42102	Chad Spencer, Superintendent of Engineering	270- 782- 1200	cspencer@bgmu.com
Warren Rural Electric Cooperative Corporation	951 Fairview Avenue, P.O. Box 1118 Bowling Green, KY 42102	Jonathan Lindsey, Field Engineer	270- 842- 6541	jonathanl@wrecc.com
Tennessee Valley Authority	6045 Russellville Road Bowling Green, KY 42101	William F. Mills, Transmission Service Manager	270- 846- 7049	wfmills@tva.gov
Bowling Green Municipal Utilities - Communication	P.O. Box 10300 Bowling Green, KY 42102	Teresa Newman, General Services Manager	270- 782- 1200	tnewman@bgmu.com
Atmos Energy Corporation - Natural Gas	3275 Highland Point Drive Owensboro, KY 42303	Ryne White, Engineer	270- 685- 8140	Ryne.White@atmosenergy.com
Boardwalk Pipeline Partners Northern Division dba / Texas Gas Transmission, LLC	Hardinsburg Compressor Station 2332 Highway 60 W. Hardinsburg, KY 40143	Kevin Carman, Manager of Regional Projects	270- 852- 1161	Kevin.Carman@bwpmlp.com
AT&T Legacy	7555 East Pleasant Valley Road, Suite 140 Independence, OH 44131	Mike Diederich, Primary SR Tech Project Management	216- 750- 0135	MD4145@att.com

## UTILITIES AND RAIL CERTIFICATION NOTE

**COUNTY: WARREN**  
**PROJECT ID NUMBER: FD52 114 0065 019-026**  
**FEDERAL NUMBER: NHPP 0651 (104)**  
**TYPE OF PROJECT: RESTORATION & REHAB**  
**ROUTE NUMBER, FACILITY NAME: I-65, LOUISVILLE - NASHVILLE ROAD**  
**SCOPE OF PROJECT: ADDRESS PAVEMENT CONDITION OF I-65 BOTH DIRECTION(S)**  
**FROM MILEPOINT 19.6 TO MILEPOINT 25.2**  
**6 YRP ITEM NUMBER: 03-20016.00**

AT&T - KY - Telephone	1150 State Street Bowling Green, KY 42101	Travis Parsley, GEO Manager	270- 846- 3196	tp2087@att.com
BlueGrass Network LLC	2902 Ring Road, P.O. Box 5012 Elizabethtown, KY 42702	Bryan Bell, Network Planning Manager	270- 769- 0339	bbell@bluegrasscellular.com
CenturyLink Communications, LLC	Tennessee Area Office	Jeffrey Cannon, Outside Plant Engineer	615- 263- 1128	Jeffrey.Cannon@centurylink.com
North Central Telephone Cooperative Inc.	872 HWY 52 East Bypass, P.O. Box 70 Lafayette, TN 37083	Troy Davis, Engineer	615- 666- 2151	trdavis@nctc.com
Windstream Communications	11101 Anderson Drive, Suite 100 Little Rock, AR 72212	Sarah Hays, Analyst II – Engineering Support	501) 748- 5864	WCI.OSP.PERMITS@windstream.com
Time Warner Cable / Spectrum Cable - CATV	P.O. Box 659 Bowling Green, KY 42102	Daryl G Hulsey, Construction Supervisor	812- 253- 2755	Daryl.Hulsey@charter.com
Bowling Green Municipal Utilities – Water & Sewer	P.O. Box 10300 Bowling Green, KY 42102	Emmet Wood, Engineering Superintendent	270- 782- 1200	ewood@BGMU.com
Warren County Water District	523 Highway US- 31W Bypass, P.O. Box 10180 Bowling Green, Kentucky 42102	Ryan Leisey, P.E., Manager of Engineering	270- 842- 0052	ryanl@warrenwater.com

**PART II**  
**SPECIFICATIONS AND STANDARD DRAWINGS**

### **SPECIFICATIONS REFERENCE**

Any reference in the plans or proposal to previous editions of the *Standard Specifications for Road and Bridge Construction* and *Standard Drawings* are superseded by *Standard Specifications for Road and Bridge Construction, Edition of 2019* and *Standard Drawings, Edition of 2020*.

## **SUPPLEMENTAL SPECIFICATIONS**

The contractor shall use the Supplemental Specifications that are effective at the time of letting.  
The Supplemental Specifications can be found at the following link:

<http://transportation.ky.gov/Construction/Pages/Kentucky-Standard-Specifications.aspx>

**PART III**

**EMPLOYMENT, WAGE AND RECORD REQUIREMENTS**

FHWA-1273 -- Revised May 1, 2012

**REQUIRED CONTRACT PROVISIONS  
FEDERAL-AID CONSTRUCTION CONTRACTS**

- I. General
- II. Nondiscrimination
- III. Nonsegregated Facilities
- IV. Davis-Bacon and Related Act Provisions
- V. Contract Work Hours and Safety Standards Act Provisions
- VI. Subletting or Assigning the Contract
- VII. Safety: Accident Prevention
- VIII. False Statements Concerning Highway Projects
- IX. Implementation of Clean Air Act and Federal Water Pollution Control Act
- X. Compliance with Governmentwide Suspension and Debarment Requirements
- XI. Certification Regarding Use of Contract Funds for Lobbying

3. A breach of any of the stipulations contained in these Required Contract Provisions may be sufficient grounds for withholding of progress payments, withholding of final payment, termination of the contract, suspension / debarment or any other action determined to be appropriate by the contracting agency and FHWA.

4. Selection of Labor: During the performance of this contract, the contractor shall not use convict labor for any purpose within the limits of a construction project on a Federal-aid highway unless it is labor performed by convicts who are on parole, supervised release, or probation. The term Federal-aid highway does not include roadways functionally classified as local roads or rural minor collectors.

**ATTACHMENTS**

A. Employment and Materials Preference for Appalachian Development Highway System or Appalachian Local Access Road Contracts (included in Appalachian contracts only)

**II. NONDISCRIMINATION**

The provisions of this section related to 23 CFR Part 230 are applicable to all Federal-aid construction contracts and to all related construction subcontracts of \$10,000 or more. The provisions of 23 CFR Part 230 are not applicable to material supply, engineering, or architectural service contracts.

**I. GENERAL**

1. Form FHWA-1273 must be physically incorporated in each construction contract funded under Title 23 (excluding emergency contracts solely intended for debris removal). The contractor (or subcontractor) must insert this form in each subcontract and further require its inclusion in all lower tier subcontracts (excluding purchase orders, rental agreements and other agreements for supplies or services).

In addition, the contractor and all subcontractors must comply with the following policies: Executive Order 11246, 41 CFR 60, 29 CFR 1625-1627, Title 23 USC Section 140, the Rehabilitation Act of 1973, as amended (29 USC 794), Title VI of the Civil Rights Act of 1964, as amended, and related regulations including 49 CFR Parts 21, 26 and 27; and 23 CFR Parts 200, 230, and 633.

The applicable requirements of Form FHWA-1273 are incorporated by reference for work done under any purchase order, rental agreement or agreement for other services. The prime contractor shall be responsible for compliance by any subcontractor, lower-tier subcontractor or service provider.

The contractor and all subcontractors must comply with: the requirements of the Equal Opportunity Clause in 41 CFR 60-1.4(b) and, for all construction contracts exceeding \$10,000, the Standard Federal Equal Employment Opportunity Construction Contract Specifications in 41 CFR 60-4.3.

Form FHWA-1273 must be included in all Federal-aid design-build contracts, in all subcontracts and in lower tier subcontracts (excluding subcontracts for design services, purchase orders, rental agreements and other agreements for supplies or services). The design-builder shall be responsible for compliance by any subcontractor, lower-tier subcontractor or service provider.

Note: The U.S. Department of Labor has exclusive authority to determine compliance with Executive Order 11246 and the policies of the Secretary of Labor including 41 CFR 60, and 29 CFR 1625-1627. The contracting agency and the FHWA have the authority and the responsibility to ensure compliance with Title 23 USC Section 140, the Rehabilitation Act of 1973, as amended (29 USC 794), and Title VI of the Civil Rights Act of 1964, as amended, and related regulations including 49 CFR Parts 21, 26 and 27; and 23 CFR Parts 200, 230, and 633.

Contracting agencies may reference Form FHWA-1273 in bid proposal or request for proposal documents, however, the Form FHWA-1273 must be physically incorporated (not referenced) in all contracts, subcontracts and lower-tier subcontracts (excluding purchase orders, rental agreements and other agreements for supplies or services related to a construction contract).

The following provision is adopted from 23 CFR 230, Appendix A, with appropriate revisions to conform to the U.S. Department of Labor (US DOL) and FHWA requirements.

2. Subject to the applicability criteria noted in the following sections, these contract provisions shall apply to all work performed on the contract by the contractor's own organization and with the assistance of workers under the contractor's immediate superintendence and to all work performed on the contract by piecework, station work, or by subcontract.

**1. Equal Employment Opportunity:** Equal employment opportunity (EEO) requirements not to discriminate and to take affirmative action to assure equal opportunity as set forth under laws, executive orders, rules, regulations (28 CFR 35, 29 CFR 1630, 29 CFR 1625-1627, 41 CFR 60 and 49 CFR 27) and orders of the Secretary of Labor as modified by the provisions prescribed herein, and imposed pursuant to 23 U.S.C. 140 shall constitute the EEO and specific affirmative action standards for the contractor's project activities under

this contract. The provisions of the Americans with Disabilities Act of 1990 (42 U.S.C. 12101 et seq.) set forth under 28 CFR 35 and 29 CFR 1630 are incorporated by reference in this contract. In the execution of this contract, the contractor agrees to comply with the following minimum specific requirement activities of EEO:

a. The contractor will work with the contracting agency and the Federal Government to ensure that it has made every good faith effort to provide equal opportunity with respect to all of its terms and conditions of employment and in their review of activities under the contract.

b. The contractor will accept as its operating policy the following statement:

"It is the policy of this Company to assure that applicants are employed, and that employees are treated during employment, without regard to their race, religion, sex, color, national origin, age or disability. Such action shall include: employment, upgrading, demotion, or transfer; recruitment or recruitment advertising; layoff or termination; rates of pay or other forms of compensation; and selection for training, including apprenticeship, pre-apprenticeship, and/or on-the-job training."

**2. EEO Officer:** The contractor will designate and make known to the contracting officers an EEO Officer who will have the responsibility for and must be capable of effectively administering and promoting an active EEO program and who must be assigned adequate authority and responsibility to do so.

**3. Dissemination of Policy:** All members of the contractor's staff who are authorized to hire, supervise, promote, and discharge employees, or who recommend such action, or who are substantially involved in such action, will be made fully cognizant of, and will implement, the contractor's EEO policy and contractual responsibilities to provide EEO in each grade and classification of employment. To ensure that the above agreement will be met, the following actions will be taken as a minimum:

a. Periodic meetings of supervisory and personnel office employees will be conducted before the start of work and then not less often than once every six months, at which time the contractor's EEO policy and its implementation will be reviewed and explained. The meetings will be conducted by the EEO Officer.

b. All new supervisory or personnel office employees will be given a thorough indoctrination by the EEO Officer, covering all major aspects of the contractor's EEO obligations within thirty days following their reporting for duty with the contractor.

c. All personnel who are engaged in direct recruitment for the project will be instructed by the EEO Officer in the contractor's procedures for locating and hiring minorities and women.

d. Notices and posters setting forth the contractor's EEO policy will be placed in areas readily accessible to employees, applicants for employment and potential employees.

e. The contractor's EEO policy and the procedures to implement such policy will be brought to the attention of employees by means of meetings, employee handbooks, or other appropriate means.

**4. Recruitment:** When advertising for employees, the contractor will include in all advertisements for employees the notation: "An Equal Opportunity Employer." All such advertisements will be placed in publications having a large circulation among minorities and women in the area from which the project work force would normally be derived.

a. The contractor will, unless precluded by a valid bargaining agreement, conduct systematic and direct recruitment through public and private employee referral sources likely to yield qualified minorities and women. To meet this requirement, the contractor will identify sources of potential minority group employees, and establish with such identified sources procedures whereby minority and women applicants may be referred to the contractor for employment consideration.

b. In the event the contractor has a valid bargaining agreement providing for exclusive hiring hall referrals, the contractor is expected to observe the provisions of that agreement to the extent that the system meets the contractor's compliance with EEO contract provisions. Where implementation of such an agreement has the effect of discriminating against minorities or women, or obligates the contractor to do the same, such implementation violates Federal nondiscrimination provisions.

c. The contractor will encourage its present employees to refer minorities and women as applicants for employment. Information and procedures with regard to referring such applicants will be discussed with employees.

**5. Personnel Actions:** Wages, working conditions, and employee benefits shall be established and administered, and personnel actions of every type, including hiring, upgrading, promotion, transfer, demotion, layoff, and termination, shall be taken without regard to race, color, religion, sex, national origin, age or disability. The following procedures shall be followed:

a. The contractor will conduct periodic inspections of project sites to insure that working conditions and employee facilities do not indicate discriminatory treatment of project site personnel.

b. The contractor will periodically evaluate the spread of wages paid within each classification to determine any evidence of discriminatory wage practices.

c. The contractor will periodically review selected personnel actions in depth to determine whether there is evidence of discrimination. Where evidence is found, the contractor will promptly take corrective action. If the review indicates that the discrimination may extend beyond the actions reviewed, such corrective action shall include all affected persons.

d. The contractor will promptly investigate all complaints of alleged discrimination made to the contractor in connection with its obligations under this contract, will attempt to resolve such complaints, and will take appropriate corrective action within a reasonable time. If the investigation indicates that the discrimination may affect persons other than the complainant, such corrective action shall include such other persons. Upon completion of each investigation, the contractor will inform every complainant of all of their avenues of appeal.

**6. Training and Promotion:**

a. The contractor will assist in locating, qualifying, and increasing the skills of minorities and women who are

applicants for employment or current employees. Such efforts should be aimed at developing full journey level status employees in the type of trade or job classification involved.

b. Consistent with the contractor's work force requirements and as permissible under Federal and State regulations, the contractor shall make full use of training programs, i.e., apprenticeship, and on-the-job training programs for the geographical area of contract performance. In the event a special provision for training is provided under this contract, this subparagraph will be superseded as indicated in the special provision. The contracting agency may reserve training positions for persons who receive welfare assistance in accordance with 23 U.S.C. 140(a).

c. The contractor will advise employees and applicants for employment of available training programs and entrance requirements for each.

d. The contractor will periodically review the training and promotion potential of employees who are minorities and women and will encourage eligible employees to apply for such training and promotion.

**7. Unions:** If the contractor relies in whole or in part upon unions as a source of employees, the contractor will use good faith efforts to obtain the cooperation of such unions to increase opportunities for minorities and women. Actions by the contractor, either directly or through a contractor's association acting as agent, will include the procedures set forth below:

a. The contractor will use good faith efforts to develop, in cooperation with the unions, joint training programs aimed toward qualifying more minorities and women for membership in the unions and increasing the skills of minorities and women so that they may qualify for higher paying employment.

b. The contractor will use good faith efforts to incorporate an EEO clause into each union agreement to the end that such union will be contractually bound to refer applicants without regard to their race, color, religion, sex, national origin, age or disability.

c. The contractor is to obtain information as to the referral practices and policies of the labor union except that to the extent such information is within the exclusive possession of the labor union and such labor union refuses to furnish such information to the contractor, the contractor shall so certify to the contracting agency and shall set forth what efforts have been made to obtain such information.

d. In the event the union is unable to provide the contractor with a reasonable flow of referrals within the time limit set forth in the collective bargaining agreement, the contractor will, through independent recruitment efforts, fill the employment vacancies without regard to race, color, religion, sex, national origin, age or disability; making full efforts to obtain qualified and/or qualifiable minorities and women. The failure of a union to provide sufficient referrals (even though it is obligated to provide exclusive referrals under the terms of a collective bargaining agreement) does not relieve the contractor from the requirements of this paragraph. In the event the union referral practice prevents the contractor from meeting the obligations pursuant to Executive Order 11246, as amended, and these special provisions, such contractor shall immediately notify the contracting agency.

**8. Reasonable Accommodation for Applicants / Employees with Disabilities:** The contractor must be familiar

with the requirements for and comply with the Americans with Disabilities Act and all rules and regulations established there under. Employers must provide reasonable accommodation in all employment activities unless to do so would cause an undue hardship.

**9. Selection of Subcontractors, Procurement of Materials and Leasing of Equipment:** The contractor shall not discriminate on the grounds of race, color, religion, sex, national origin, age or disability in the selection and retention of subcontractors, including procurement of materials and leases of equipment. The contractor shall take all necessary and reasonable steps to ensure nondiscrimination in the administration of this contract.

a. The contractor shall notify all potential subcontractors and suppliers and lessors of their EEO obligations under this contract.

b. The contractor will use good faith efforts to ensure subcontractor compliance with their EEO obligations.

**10. Assurance Required by 49 CFR 26.13(b):**

a. The requirements of 49 CFR Part 26 and the State DOT's U.S. DOT-approved DBE program are incorporated by reference.

b. The contractor or subcontractor shall not discriminate on the basis of race, color, national origin, or sex in the performance of this contract. The contractor shall carry out applicable requirements of 49 CFR Part 26 in the award and administration of DOT-assisted contracts. Failure by the contractor to carry out these requirements is a material breach of this contract, which may result in the termination of this contract or such other remedy as the contracting agency deems appropriate.

**11. Records and Reports:** The contractor shall keep such records as necessary to document compliance with the EEO requirements. Such records shall be retained for a period of three years following the date of the final payment to the contractor for all contract work and shall be available at reasonable times and places for inspection by authorized representatives of the contracting agency and the FHWA.

a. The records kept by the contractor shall document the following:

(1) The number and work hours of minority and non-minority group members and women employed in each work classification on the project;

(2) The progress and efforts being made in cooperation with unions, when applicable, to increase employment opportunities for minorities and women; and

(3) The progress and efforts being made in locating, hiring, training, qualifying, and upgrading minorities and women;

b. The contractors and subcontractors will submit an annual report to the contracting agency each July for the duration of the project, indicating the number of minority, women, and non-minority group employees currently engaged in each work classification required by the contract work. This information is to be reported on [Form FHWA-1391](#). The staffing data should represent the project work force on board in all or any part of the last payroll period preceding the end of July. If on-the-job training is being required by special provision, the contractor

will be required to collect and report training data. The employment data should reflect the work force on board during all or any part of the last payroll period preceding the end of July.

**III. NONSEGREGATED FACILITIES**

This provision is applicable to all Federal-aid construction contracts and to all related construction subcontracts of \$10,000 or more.

The contractor must ensure that facilities provided for employees are provided in such a manner that segregation on the basis of race, color, religion, sex, or national origin cannot result. The contractor may neither require such segregated use by written or oral policies nor tolerate such use by employee custom. The contractor's obligation extends further to ensure that its employees are not assigned to perform their services at any location, under the contractor's control, where the facilities are segregated. The term "facilities" includes waiting rooms, work areas, restaurants and other eating areas, time clocks, restrooms, washrooms, locker rooms, and other storage or dressing areas, parking lots, drinking fountains, recreation or entertainment areas, transportation, and housing provided for employees. The contractor shall provide separate or single-user restrooms and necessary dressing or sleeping areas to assure privacy between sexes.

**IV. DAVIS-BACON AND RELATED ACT PROVISIONS**

This section is applicable to all Federal-aid construction projects exceeding \$2,000 and to all related subcontracts and lower-tier subcontracts (regardless of subcontract size). The requirements apply to all projects located within the right-of-way of a roadway that is functionally classified as Federal-aid highway. This excludes roadways functionally classified as local roads or rural minor collectors, which are exempt. Contracting agencies may elect to apply these requirements to other projects.

The following provisions are from the U.S. Department of Labor regulations in 29 CFR 5.5 "Contract provisions and related matters" with minor revisions to conform to the FHWA-1273 format and FHWA program requirements.

**1. Minimum wages**

a. All laborers and mechanics employed or working upon the site of the work, will be paid unconditionally and not less often than once a week, and without subsequent deduction or rebate on any account (except such payroll deductions as are permitted by regulations issued by the Secretary of Labor under the Copeland Act (29 CFR part 3)), the full amount of wages and bona fide fringe benefits (or cash equivalents thereof) due at time of payment computed at rates not less than those contained in the wage determination of the Secretary of Labor which is attached hereto and made a part hereof, regardless of any contractual relationship which may be alleged to exist between the contractor and such laborers and mechanics.

Contributions made or costs reasonably anticipated for bona fide fringe benefits under section 1(b)(2) of the Davis-Bacon Act on behalf of laborers or mechanics are considered wages paid to such laborers or mechanics, subject to the provisions

of paragraph 1.d. of this section; also, regular contributions made or costs incurred for more than a weekly period (but not less often than quarterly) under plans, funds, or programs which cover the particular weekly period, are deemed to be constructively made or incurred during such weekly period. Such laborers and mechanics shall be paid the appropriate wage rate and fringe benefits on the wage determination for the classification of work actually performed, without regard to skill, except as provided in 29 CFR 5.5(a)(4). Laborers or mechanics performing work in more than one classification may be compensated at the rate specified for each classification for the time actually worked therein: Provided, That the employer's payroll records accurately set forth the time spent in each classification in which work is performed. The wage determination (including any additional classification and wage rates conformed under paragraph 1.b. of this section) and the Davis-Bacon poster (WH-1321) shall be posted at all times by the contractor and its subcontractors at the site of the work in a prominent and accessible place where it can be easily seen by the workers.

b.(1) The contracting officer shall require that any class of laborers or mechanics, including helpers, which is not listed in the wage determination and which is to be employed under the contract shall be classified in conformance with the wage determination. The contracting officer shall approve an additional classification and wage rate and fringe benefits therefore only when the following criteria have been met:

- (i) The work to be performed by the classification requested is not performed by a classification in the wage determination; and
- (ii) The classification is utilized in the area by the construction industry; and
- (iii) The proposed wage rate, including any bona fide fringe benefits, bears a reasonable relationship to the wage rates contained in the wage determination.

(2) If the contractor and the laborers and mechanics to be employed in the classification (if known), or their representatives, and the contracting officer agree on the classification and wage rate (including the amount designated for fringe benefits where appropriate), a report of the action taken shall be sent by the contracting officer to the Administrator of the Wage and Hour Division, Employment Standards Administration, U.S. Department of Labor, Washington, DC 20210. The Administrator, or an authorized representative, will approve, modify, or disapprove every additional classification action within 30 days of receipt and so advise the contracting officer or will notify the contracting officer within the 30-day period that additional time is necessary.

(3) In the event the contractor, the laborers or mechanics to be employed in the classification or their representatives, and the contracting officer do not agree on the proposed classification and wage rate (including the amount designated for fringe benefits, where appropriate), the contracting officer shall refer the questions, including the views of all interested parties and the recommendation of the contracting officer, to the Wage and Hour Administrator for determination. The Wage and Hour Administrator, or an authorized representative, will issue a determination within 30 days of receipt and so advise the contracting officer or

will notify the contracting officer within the 30-day period that additional time is necessary.

(4) The wage rate (including fringe benefits where appropriate) determined pursuant to paragraphs 1.b.(2) or 1.b.(3) of this section, shall be paid to all workers performing work in the classification under this contract from the first day on which work is performed in the classification.

c. Whenever the minimum wage rate prescribed in the contract for a class of laborers or mechanics includes a fringe benefit which is not expressed as an hourly rate, the contractor shall either pay the benefit as stated in the wage determination or shall pay another bona fide fringe benefit or an hourly cash equivalent thereof.

d. If the contractor does not make payments to a trustee or other third person, the contractor may consider as part of the wages of any laborer or mechanic the amount of any costs reasonably anticipated in providing bona fide fringe benefits under a plan or program. Provided, That the Secretary of Labor has found, upon the written request of the contractor, that the applicable standards of the Davis-Bacon Act have been met. The Secretary of Labor may require the contractor to set aside in a separate account assets for the meeting of obligations under the plan or program.

## 2. Withholding

The contracting agency shall upon its own action or upon written request of an authorized representative of the Department of Labor, withhold or cause to be withheld from the contractor under this contract, or any other Federal contract with the same prime contractor, or any other federally-assisted contract subject to Davis-Bacon prevailing wage requirements, which is held by the same prime contractor, so much of the accrued payments or advances as may be considered necessary to pay laborers and mechanics, including apprentices, trainees, and helpers, employed by the contractor or any subcontractor the full amount of wages required by the contract. In the event of failure to pay any laborer or mechanic, including any apprentice, trainee, or helper, employed or working on the site of the work, all or part of the wages required by the contract, the contracting agency may, after written notice to the contractor, take such action as may be necessary to cause the suspension of any further payment, advance, or guarantee of funds until such violations have ceased.

## 3. Payrolls and basic records

a. Payrolls and basic records relating thereto shall be maintained by the contractor during the course of the work and preserved for a period of three years thereafter for all laborers and mechanics working at the site of the work. Such records shall contain the name, address, and social security number of each such worker, his or her correct classification, hourly rates of wages paid (including rates of contributions or costs anticipated for bona fide fringe benefits or cash equivalents thereof of the types described in section 1(b)(2)(B) of the Davis-Bacon Act), daily and weekly number of hours worked, deductions made and actual wages paid. Whenever the Secretary of Labor has found under 29 CFR 5.5(a)(1)(iv) that the wages of any laborer or mechanic include the amount of any costs reasonably anticipated in providing benefits under a plan or program described in section 1(b)(2)(B) of the Davis-

Bacon Act, the contractor shall maintain records which show that the commitment to provide such benefits is enforceable, that the plan or program is financially responsible, and that the plan or program has been communicated in writing to the laborers or mechanics affected, and records which show the costs anticipated or the actual cost incurred in providing such benefits. Contractors employing apprentices or trainees under approved programs shall maintain written evidence of the registration of apprenticeship programs and certification of trainee programs, the registration of the apprentices and trainees, and the ratios and wage rates prescribed in the applicable programs.

b. (1) The contractor shall submit weekly for each week in which any contract work is performed a copy of all payrolls to the contracting agency. The payrolls submitted shall set out accurately and completely all of the information required to be maintained under 29 CFR 5.5(a)(3)(i), except that full social security numbers and home addresses shall not be included on weekly transmittals. Instead the payrolls shall only need to include an individually identifying number for each employee (e.g., the last four digits of the employee's social security number). The required weekly payroll information may be submitted in any form desired. Optional Form WH-347 is available for this purpose from the Wage and Hour Division Web site at <http://www.dol.gov/esa/whd/forms/wh347instr.htm> or its successor site. The prime contractor is responsible for the submission of copies of payrolls by all subcontractors. Contractors and subcontractors shall maintain the full social security number and current address of each covered worker, and shall provide them upon request to the contracting agency for transmission to the State DOT, the FHWA or the Wage and Hour Division of the Department of Labor for purposes of an investigation or audit of compliance with prevailing wage requirements. It is not a violation of this section for a prime contractor to require a subcontractor to provide addresses and social security numbers to the prime contractor for its own records, without weekly submission to the contracting agency..

(2) Each payroll submitted shall be accompanied by a "Statement of Compliance," signed by the contractor or subcontractor or his or her agent who pays or supervises the payment of the persons employed under the contract and shall certify the following:

(i) That the payroll for the payroll period contains the information required to be provided under §5.5 (a)(3)(ii) of Regulations, 29 CFR part 5, the appropriate information is being maintained under §5.5 (a)(3)(i) of Regulations, 29 CFR part 5, and that such information is correct and complete;

(ii) That each laborer or mechanic (including each helper, apprentice, and trainee) employed on the contract during the payroll period has been paid the full weekly wages earned, without rebate, either directly or indirectly, and that no deductions have been made either directly or indirectly from the full wages earned, other than permissible deductions as set forth in Regulations, 29 CFR part 3;

(iii) That each laborer or mechanic has been paid not less than the applicable wage rates and fringe benefits or cash equivalents for the classification of work performed, as specified in the applicable wage determination incorporated into the contract.

(3) The weekly submission of a properly executed certification set forth on the reverse side of Optional Form WH-347 shall satisfy the requirement for submission of the "Statement of Compliance" required by paragraph 3.b.(2) of this section.

(4) The falsification of any of the above certifications may subject the contractor or subcontractor to civil or criminal prosecution under section 1001 of title 18 and section 231 of title 31 of the United States Code.

c. The contractor or subcontractor shall make the records required under paragraph 3.a. of this section available for inspection, copying, or transcription by authorized representatives of the contracting agency, the State DOT, the FHWA, or the Department of Labor, and shall permit such representatives to interview employees during working hours on the job. If the contractor or subcontractor fails to submit the required records or to make them available, the FHWA may, after written notice to the contractor, the contracting agency or the State DOT, take such action as may be necessary to cause the suspension of any further payment, advance, or guarantee of funds. Furthermore, failure to submit the required records upon request or to make such records available may be grounds for debarment action pursuant to 29 CFR 5.12.

#### 4. Apprentices and trainees

##### a. Apprentices (programs of the USDOL).

Apprentices will be permitted to work at less than the predetermined rate for the work they performed when they are employed pursuant to and individually registered in a bona fide apprenticeship program registered with the U.S. Department of Labor, Employment and Training Administration, Office of Apprenticeship Training, Employer and Labor Services, or with a State Apprenticeship Agency recognized by the Office, or if a person is employed in his or her first 90 days of probationary employment as an apprentice in such an apprenticeship program, who is not individually registered in the program, but who has been certified by the Office of Apprenticeship Training, Employer and Labor Services or a State Apprenticeship Agency (where appropriate) to be eligible for probationary employment as an apprentice.

The allowable ratio of apprentices to journeymen on the job site in any craft classification shall not be greater than the ratio permitted to the contractor as to the entire work force under the registered program. Any worker listed on a payroll at an apprentice wage rate, who is not registered or otherwise employed as stated above, shall be paid not less than the applicable wage rate on the wage determination for the classification of work actually performed. In addition, any apprentice performing work on the job site in excess of the ratio permitted under the registered program shall be paid not less than the applicable wage rate on the wage determination for the work actually performed. Where a contractor is performing construction on a project in a locality other than that in which its program is registered, the ratios and wage rates (expressed in percentages of the journeyman's hourly rate) specified in the contractor's or subcontractor's registered program shall be observed.

Every apprentice must be paid at not less than the rate specified in the registered program for the apprentice's level of progress, expressed as a percentage of the journeymen hourly

rate specified in the applicable wage determination. Apprentices shall be paid fringe benefits in accordance with the provisions of the apprenticeship program. If the apprenticeship program does not specify fringe benefits, apprentices must be paid the full amount of fringe benefits listed on the wage determination for the applicable classification. If the Administrator determines that a different practice prevails for the applicable apprentice classification, fringes shall be paid in accordance with that determination.

In the event the Office of Apprenticeship Training, Employer and Labor Services, or a State Apprenticeship Agency recognized by the Office, withdraws approval of an apprenticeship program, the contractor will no longer be permitted to utilize apprentices at less than the applicable predetermined rate for the work performed until an acceptable program is approved.

##### b. Trainees (programs of the USDOL).

Except as provided in 29 CFR 5.16, trainees will not be permitted to work at less than the predetermined rate for the work performed unless they are employed pursuant to and individually registered in a program which has received prior approval, evidenced by formal certification by the U.S. Department of Labor, Employment and Training Administration.

The ratio of trainees to journeymen on the job site shall not be greater than permitted under the plan approved by the Employment and Training Administration.

Every trainee must be paid at not less than the rate specified in the approved program for the trainee's level of progress, expressed as a percentage of the journeyman hourly rate specified in the applicable wage determination. Trainees shall be paid fringe benefits in accordance with the provisions of the trainee program. If the trainee program does not mention fringe benefits, trainees shall be paid the full amount of fringe benefits listed on the wage determination unless the Administrator of the Wage and Hour Division determines that there is an apprenticeship program associated with the corresponding journeyman wage rate on the wage determination which provides for less than full fringe benefits for apprentices. Any employee listed on the payroll at a trainee rate who is not registered and participating in a training plan approved by the Employment and Training Administration shall be paid not less than the applicable wage rate on the wage determination for the classification of work actually performed. In addition, any trainee performing work on the job site in excess of the ratio permitted under the registered program shall be paid not less than the applicable wage rate on the wage determination for the work actually performed.

In the event the Employment and Training Administration withdraws approval of a training program, the contractor will no longer be permitted to utilize trainees at less than the applicable predetermined rate for the work performed until an acceptable program is approved.

c. Equal employment opportunity. The utilization of apprentices, trainees and journeymen under this part shall be in conformity with the equal employment opportunity requirements of Executive Order 11246, as amended, and 29 CFR part 30.

d. Apprentices and Trainees (programs of the U.S. DOT).

Apprentices and trainees working under apprenticeship and skill training programs which have been certified by the Secretary of Transportation as promoting EEO in connection with Federal-aid highway construction programs are not subject to the requirements of paragraph 4 of this Section IV. The straight time hourly wage rates for apprentices and trainees under such programs will be established by the particular programs. The ratio of apprentices and trainees to journeymen shall not be greater than permitted by the terms of the particular program.

**5. Compliance with Copeland Act requirements.** The contractor shall comply with the requirements of 29 CFR part 3, which are incorporated by reference in this contract.

**6. Subcontracts.** The contractor or subcontractor shall insert Form FHWA-1273 in any subcontracts and also require the subcontractors to include Form FHWA-1273 in any lower tier subcontracts. The prime contractor shall be responsible for the compliance by any subcontractor or lower tier subcontractor with all the contract clauses in 29 CFR 5.5.

**7. Contract termination: debarment.** A breach of the contract clauses in 29 CFR 5.5 may be grounds for termination of the contract, and for debarment as a contractor and a subcontractor as provided in 29 CFR 5.12.

**8. Compliance with Davis-Bacon and Related Act requirements.** All rulings and interpretations of the Davis-Bacon and Related Acts contained in 29 CFR parts 1, 3, and 5 are herein incorporated by reference in this contract.

**9. Disputes concerning labor standards.** Disputes arising out of the labor standards provisions of this contract shall not be subject to the general disputes clause of this contract. Such disputes shall be resolved in accordance with the procedures of the Department of Labor set forth in 29 CFR parts 5, 6, and 7. Disputes within the meaning of this clause include disputes between the contractor (or any of its subcontractors) and the contracting agency, the U.S. Department of Labor, or the employees or their representatives.

**10. Certification of eligibility.**

a. By entering into this contract, the contractor certifies that neither it (nor he or she) nor any person or firm who has an interest in the contractor's firm is a person or firm ineligible to be awarded Government contracts by virtue of section 3(a) of the Davis-Bacon Act or 29 CFR 5.12(a)(1).

b. No part of this contract shall be subcontracted to any person or firm ineligible for award of a Government contract by virtue of section 3(a) of the Davis-Bacon Act or 29 CFR 5.12(a)(1).

c. The penalty for making false statements is prescribed in the U.S. Criminal Code, 18 U.S.C. 1001.

**V. CONTRACT WORK HOURS AND SAFETY STANDARDS ACT**

The following clauses apply to any Federal-aid construction contract in an amount in excess of \$100,000 and subject to the overtime provisions of the Contract Work Hours and Safety Standards Act. These clauses shall be inserted in addition to the clauses required by 29 CFR 5.5(a) or 29 CFR 4.6. As used in this paragraph, the terms laborers and mechanics include watchmen and guards.

**1. Overtime requirements.** No contractor or subcontractor contracting for any part of the contract work which may require or involve the employment of laborers or mechanics shall require or permit any such laborer or mechanic in any workweek in which he or she is employed on such work to work in excess of forty hours in such workweek unless such laborer or mechanic receives compensation at a rate not less than one and one-half times the basic rate of pay for all hours worked in excess of forty hours in such workweek.

**2. Violation; liability for unpaid wages; liquidated damages.** In the event of any violation of the clause set forth in paragraph (1.) of this section, the contractor and any subcontractor responsible therefor shall be liable for the unpaid wages. In addition, such contractor and subcontractor shall be liable to the United States (in the case of work done under contract for the District of Columbia or a territory, to such District or to such territory), for liquidated damages. Such liquidated damages shall be computed with respect to each individual laborer or mechanic, including watchmen and guards, employed in violation of the clause set forth in paragraph (1.) of this section, in the sum of \$10 for each calendar day on which such individual was required or permitted to work in excess of the standard workweek of forty hours without payment of the overtime wages required by the clause set forth in paragraph (1.) of this section.

**3. Withholding for unpaid wages and liquidated damages.** The FHWA or the contracting agency shall upon its own action or upon written request of an authorized representative of the Department of Labor withhold or cause to be withheld, from any moneys payable on account of work performed by the contractor or subcontractor under any such contract or any other Federal contract with the same prime contractor, or any other federally-assisted contract subject to the Contract Work Hours and Safety Standards Act, which is held by the same prime contractor, such sums as may be determined to be necessary to satisfy any liabilities of such contractor or subcontractor for unpaid wages and liquidated damages as provided in the clause set forth in paragraph (2.) of this section.

**4. Subcontracts.** The contractor or subcontractor shall insert in any subcontracts the clauses set forth in paragraph (1.) through (4.) of this section and also a clause requiring the subcontractors to include these clauses in any lower tier subcontracts. The prime contractor shall be responsible for compliance by any subcontractor or lower tier subcontractor with the clauses set forth in paragraphs (1.) through (4.) of this section.

## VI. SUBLETTING OR ASSIGNING THE CONTRACT

This provision is applicable to all Federal-aid construction contracts on the National Highway System.

1. The contractor shall perform with its own organization contract work amounting to not less than 30 percent (or a greater percentage if specified elsewhere in the contract) of the total original contract price, excluding any specialty items designated by the contracting agency. Specialty items may be performed by subcontract and the amount of any such specialty items performed may be deducted from the total original contract price before computing the amount of work required to be performed by the contractor's own organization (23 CFR 635.116).

a. The term "perform work with its own organization" refers to workers employed or leased by the prime contractor, and equipment owned or rented by the prime contractor, with or without operators. Such term does not include employees or equipment of a subcontractor or lower tier subcontractor, agents of the prime contractor, or any other assignees. The term may include payments for the costs of hiring leased employees from an employee leasing firm meeting all relevant Federal and State regulatory requirements. Leased employees may only be included in this term if the prime contractor meets all of the following conditions:

(1) the prime contractor maintains control over the supervision of the day-to-day activities of the leased employees;

(2) the prime contractor remains responsible for the quality of the work of the leased employees;

(3) the prime contractor retains all power to accept or exclude individual employees from work on the project; and

(4) the prime contractor remains ultimately responsible for the payment of predetermined minimum wages, the submission of payrolls, statements of compliance and all other Federal regulatory requirements.

b. "Specialty Items" shall be construed to be limited to work that requires highly specialized knowledge, abilities, or equipment not ordinarily available in the type of contracting organizations qualified and expected to bid or propose on the contract as a whole and in general are to be limited to minor components of the overall contract.

2. The contract amount upon which the requirements set forth in paragraph (1) of Section VI is computed includes the cost of material and manufactured products which are to be purchased or produced by the contractor under the contract provisions.

3. The contractor shall furnish (a) a competent superintendent or supervisor who is employed by the firm, has full authority to direct performance of the work in accordance with the contract requirements, and is in charge of all construction operations (regardless of who performs the work) and (b) such other of its own organizational resources (supervision, management, and engineering services) as the contracting officer determines is necessary to assure the performance of the contract.

4. No portion of the contract shall be sublet, assigned or otherwise disposed of except with the written consent of the contracting officer, or authorized representative, and such consent when given shall not be construed to relieve the contractor of any responsibility for the fulfillment of the contract. Written consent will be given only after the contracting agency has assured that each subcontract is

evidenced in writing and that it contains all pertinent provisions and requirements of the prime contract.

5. The 30% self-performance requirement of paragraph (1) is not applicable to design-build contracts; however, contracting agencies may establish their own self-performance requirements.

## VII. SAFETY: ACCIDENT PREVENTION

This provision is applicable to all Federal-aid construction contracts and to all related subcontracts.

1. In the performance of this contract the contractor shall comply with all applicable Federal, State, and local laws governing safety, health, and sanitation (23 CFR 635). The contractor shall provide all safeguards, safety devices and protective equipment and take any other needed actions as it determines, or as the contracting officer may determine, to be reasonably necessary to protect the life and health of employees on the job and the safety of the public and to protect property in connection with the performance of the work covered by the contract.

2. It is a condition of this contract, and shall be made a condition of each subcontract, which the contractor enters into pursuant to this contract, that the contractor and any subcontractor shall not permit any employee, in performance of the contract, to work in surroundings or under conditions which are unsanitary, hazardous or dangerous to his/her health or safety, as determined under construction safety and health standards (29 CFR 1926) promulgated by the Secretary of Labor, in accordance with Section 107 of the Contract Work Hours and Safety Standards Act (40 U.S.C. 3704).

3. Pursuant to 29 CFR 1926.3, it is a condition of this contract that the Secretary of Labor or authorized representative thereof, shall have right of entry to any site of contract performance to inspect or investigate the matter of compliance with the construction safety and health standards and to carry out the duties of the Secretary under Section 107 of the Contract Work Hours and Safety Standards Act (40 U.S.C.3704).

## VIII. FALSE STATEMENTS CONCERNING HIGHWAY PROJECTS

This provision is applicable to all Federal-aid construction contracts and to all related subcontracts.

In order to assure high quality and durable construction in conformity with approved plans and specifications and a high degree of reliability on statements and representations made by engineers, contractors, suppliers, and workers on Federal-aid highway projects, it is essential that all persons concerned with the project perform their functions as carefully, thoroughly, and honestly as possible. Willful falsification, distortion, or misrepresentation with respect to any facts related to the project is a violation of Federal law. To prevent any misunderstanding regarding the seriousness of these and similar acts, Form FHWA-1022 shall be posted on each Federal-aid highway project (23 CFR 635) in one or more places where it is readily available to all persons concerned with the project:

18 U.S.C. 1020 reads as follows:

"Whoever, being an officer, agent, or employee of the United States, or of any State or Territory, or whoever, whether a person, association, firm, or corporation, knowingly makes any false statement, false representation, or false report as to the character, quality, quantity, or cost of the material used or to be used, or the quantity or quality of the work performed or to be performed, or the cost thereof in connection with the submission of plans, maps, specifications, contracts, or costs of construction on any highway or related project submitted for approval to the Secretary of Transportation; or

Whoever knowingly makes any false statement, false representation, false report or false claim with respect to the character, quality, quantity, or cost of any work performed or to be performed, or materials furnished or to be furnished, in connection with the construction of any highway or related project approved by the Secretary of Transportation; or

Whoever knowingly makes any false statement or false representation as to material fact in any statement, certificate, or report submitted pursuant to provisions of the Federal-aid Roads Act approved July 1, 1916, (39 Stat. 355), as amended and supplemented;

Shall be fined under this title or imprisoned not more than 5 years or both."

**IX. IMPLEMENTATION OF CLEAN AIR ACT AND FEDERAL WATER POLLUTION CONTROL ACT**

This provision is applicable to all Federal-aid construction contracts and to all related subcontracts.

By submission of this bid/proposal or the execution of this contract, or subcontract, as appropriate, the bidder, proposer, Federal-aid construction contractor, or subcontractor, as appropriate, will be deemed to have stipulated as follows:

1. That any person who is or will be utilized in the performance of this contract is not prohibited from receiving an award due to a violation of Section 508 of the Clean Water Act or Section 306 of the Clean Air Act.

2. That the contractor agrees to include or cause to be included the requirements of paragraph (1) of this Section X in every subcontract, and further agrees to take such action as the contracting agency may direct as a means of enforcing such requirements.

**X. CERTIFICATION REGARDING DEBARMENT, SUSPENSION, INELIGIBILITY AND VOLUNTARY EXCLUSION**

This provision is applicable to all Federal-aid construction contracts, design-build contracts, subcontracts, lower-tier subcontracts, purchase orders, lease agreements, consultant contracts or any other covered transaction requiring FHWA approval or that is estimated to cost \$25,000 or more – as defined in 2 CFR Parts 180 and 1200.

**1. Instructions for Certification – First Tier Participants:**

a. By signing and submitting this proposal, the prospective first tier participant is providing the certification set out below.

b. The inability of a person to provide the certification set out below will not necessarily result in denial of participation in this

covered transaction. The prospective first tier participant shall submit an explanation of why it cannot provide the certification set out below. The certification or explanation will be considered in connection with the department or agency's determination whether to enter into this transaction. However, failure of the prospective first tier participant to furnish a certification or an explanation shall disqualify such a person from participation in this transaction.

c. The certification in this clause is a material representation of fact upon which reliance was placed when the contracting agency determined to enter into this transaction. If it is later determined that the prospective participant knowingly rendered an erroneous certification, in addition to other remedies available to the Federal Government, the contracting agency may terminate this transaction for cause of default.

d. The prospective first tier participant shall provide immediate written notice to the contracting agency to whom this proposal is submitted if any time the prospective first tier participant learns that its certification was erroneous when submitted or has become erroneous by reason of changed circumstances.

e. The terms "covered transaction," "debarred," "suspended," "ineligible," "participant," "person," "principal," and "voluntarily excluded," as used in this clause, are defined in 2 CFR Parts 180 and 1200. "First Tier Covered Transactions" refers to any covered transaction between a grantee or subgrantee of Federal funds and a participant (such as the prime or general contract). "Lower Tier Covered Transactions" refers to any covered transaction under a First Tier Covered Transaction (such as subcontracts). "First Tier Participant" refers to the participant who has entered into a covered transaction with a grantee or subgrantee of Federal funds (such as the prime or general contractor). "Lower Tier Participant" refers any participant who has entered into a covered transaction with a First Tier Participant or other Lower Tier Participants (such as subcontractors and suppliers).

f. The prospective first tier participant agrees by submitting this proposal that, should the proposed covered transaction be entered into, it shall not knowingly enter into any lower tier covered transaction with a person who is debarred, suspended, declared ineligible, or voluntarily excluded from participation in this covered transaction, unless authorized by the department or agency entering into this transaction.

g. The prospective first tier participant further agrees by submitting this proposal that it will include the clause titled "Certification Regarding Debarment, Suspension, Ineligibility and Voluntary Exclusion-Lower Tier Covered Transactions," provided by the department or contracting agency, entering into this covered transaction, without modification, in all lower tier covered transactions and in all solicitations for lower tier covered transactions exceeding the \$25,000 threshold.

h. A participant in a covered transaction may rely upon a certification of a prospective participant in a lower tier covered transaction that is not debarred, suspended, ineligible, or voluntarily excluded from the covered transaction, unless it knows that the certification is erroneous. A participant is responsible for ensuring that its principals are not suspended, debarred, or otherwise ineligible to participate in covered transactions. To verify the eligibility of its principals, as well as the eligibility of any lower tier prospective participants, each participant may, but is not required to, check the Excluded Parties List System website (<https://www.epls.gov/>), which is compiled by the General Services Administration.

i. Nothing contained in the foregoing shall be construed to require the establishment of a system of records in order to render in good faith the certification required by this clause. The knowledge and information of the prospective participant is not required to exceed that which is normally possessed by a prudent person in the ordinary course of business dealings.

j. Except for transactions authorized under paragraph (f) of these instructions, if a participant in a covered transaction knowingly enters into a lower tier covered transaction with a person who is suspended, debarred, ineligible, or voluntarily excluded from participation in this transaction, in addition to other remedies available to the Federal Government, the department or agency may terminate this transaction for cause or default.

\*\*\*\*\*

**2. Certification Regarding Debarment, Suspension, Ineligibility and Voluntary Exclusion – First Tier Participants:**

a. The prospective first tier participant certifies to the best of its knowledge and belief, that it and its principals:

(1) Are not presently debarred, suspended, proposed for debarment, declared ineligible, or voluntarily excluded from participating in covered transactions by any Federal department or agency;

(2) Have not within a three-year period preceding this proposal been convicted of or had a civil judgment rendered against them for commission of fraud or a criminal offense in connection with obtaining, attempting to obtain, or performing a public (Federal, State or local) transaction or contract under a public transaction; violation of Federal or State antitrust statutes or commission of embezzlement, theft, forgery, bribery, falsification or destruction of records, making false statements, or receiving stolen property;

(3) Are not presently indicted for or otherwise criminally or civilly charged by a governmental entity (Federal, State or local) with commission of any of the offenses enumerated in paragraph (a)(2) of this certification; and

(4) Have not within a three-year period preceding this application/proposal had one or more public transactions (Federal, State or local) terminated for cause or default.

b. Where the prospective participant is unable to certify to any of the statements in this certification, such prospective participant shall attach an explanation to this proposal.

**2. Instructions for Certification - Lower Tier Participants:**

(Applicable to all subcontracts, purchase orders and other lower tier transactions requiring prior FHWA approval or estimated to cost \$25,000 or more - 2 CFR Parts 180 and 1200)

a. By signing and submitting this proposal, the prospective lower tier is providing the certification set out below.

b. The certification in this clause is a material representation of fact upon which reliance was placed when this transaction was entered into. If it is later determined that the prospective lower tier participant knowingly rendered an erroneous certification, in addition to other remedies available to the Federal Government, the department, or agency with which

this transaction originated may pursue available remedies, including suspension and/or debarment.

c. The prospective lower tier participant shall provide immediate written notice to the person to which this proposal is submitted if at any time the prospective lower tier participant learns that its certification was erroneous by reason of changed circumstances.

d. The terms "covered transaction," "debarred," "suspended," "ineligible," "participant," "person," "principal," and "voluntarily excluded," as used in this clause, are defined in 2 CFR Parts 180 and 1200. You may contact the person to which this proposal is submitted for assistance in obtaining a copy of those regulations. "First Tier Covered Transactions" refers to any covered transaction between a grantee or subgrantee of Federal funds and a participant (such as the prime or general contract). "Lower Tier Covered Transactions" refers to any covered transaction under a First Tier Covered Transaction (such as subcontracts). "First Tier Participant" refers to the participant who has entered into a covered transaction with a grantee or subgrantee of Federal funds (such as the prime or general contractor). "Lower Tier Participant" refers any participant who has entered into a covered transaction with a First Tier Participant or other Lower Tier Participants (such as subcontractors and suppliers).

e. The prospective lower tier participant agrees by submitting this proposal that, should the proposed covered transaction be entered into, it shall not knowingly enter into any lower tier covered transaction with a person who is debarred, suspended, declared ineligible, or voluntarily excluded from participation in this covered transaction, unless authorized by the department or agency with which this transaction originated.

f. The prospective lower tier participant further agrees by submitting this proposal that it will include this clause titled "Certification Regarding Debarment, Suspension, Ineligibility and Voluntary Exclusion-Lower Tier Covered Transaction," without modification, in all lower tier covered transactions and in all solicitations for lower tier covered transactions exceeding the \$25,000 threshold.

g. A participant in a covered transaction may rely upon a certification of a prospective participant in a lower tier covered transaction that is not debarred, suspended, ineligible, or voluntarily excluded from the covered transaction, unless it knows that the certification is erroneous. A participant is responsible for ensuring that its principals are not suspended, debarred, or otherwise ineligible to participate in covered transactions. To verify the eligibility of its principals, as well as the eligibility of any lower tier prospective participants, each participant may, but is not required to, check the Excluded Parties List System website (<https://www.epls.gov/>), which is compiled by the General Services Administration.

h. Nothing contained in the foregoing shall be construed to require establishment of a system of records in order to render in good faith the certification required by this clause. The knowledge and information of participant is not required to exceed that which is normally possessed by a prudent person in the ordinary course of business dealings.

i. Except for transactions authorized under paragraph e of these instructions, if a participant in a covered transaction knowingly enters into a lower tier covered transaction with a person who is suspended, debarred, ineligible, or voluntarily excluded from participation in this transaction, in addition to other remedies available to the Federal Government, the

department or agency with which this transaction originated may pursue available remedies, including suspension and/or debarment.

\* \* \* \* \*

**Certification Regarding Debarment, Suspension, Ineligibility and Voluntary Exclusion--Lower Tier Participants:**

1. The prospective lower tier participant certifies, by submission of this proposal, that neither it nor its principals is presently debarred, suspended, proposed for debarment, declared ineligible, or voluntarily excluded from participating in covered transactions by any Federal department or agency.

2. Where the prospective lower tier participant is unable to certify to any of the statements in this certification, such prospective participant shall attach an explanation to this proposal.

\* \* \* \* \*

**XI. CERTIFICATION REGARDING USE OF CONTRACT FUNDS FOR LOBBYING**

This provision is applicable to all Federal-aid construction contracts and to all related subcontracts which exceed \$100,000 (49 CFR 20).

1. The prospective participant certifies, by signing and submitting this bid or proposal, to the best of his or her knowledge and belief, that:

a. No Federal appropriated funds have been paid or will be paid, by or on behalf of the undersigned, to any person for influencing or attempting to influence an officer or employee of any Federal agency, a Member of Congress, an officer or employee of Congress, or an employee of a Member of Congress in connection with the awarding of any Federal contract, the making of any Federal grant, the making of any Federal loan, the entering into of any cooperative agreement, and the extension, continuation, renewal, amendment, or modification of any Federal contract, grant, loan, or cooperative agreement.

b. If any funds other than Federal appropriated funds have been paid or will be paid to any person for influencing or attempting to influence an officer or employee of any Federal agency, a Member of Congress, an officer or employee of Congress, or an employee of a Member of Congress in connection with this Federal contract, grant, loan, or cooperative agreement, the undersigned shall complete and submit Standard Form-LLL, "Disclosure Form to Report Lobbying," in accordance with its instructions.

2. This certification is a material representation of fact upon which reliance was placed when this transaction was made or entered into. Submission of this certification is a prerequisite for making or entering into this transaction imposed by 31 U.S.C. 1352. Any person who fails to file the required certification shall be subject to a civil penalty of not less than \$10,000 and not more than \$100,000 for each such failure.

3. The prospective participant also agrees by submitting its bid or proposal that the participant shall require that the language of this certification be included in all lower tier subcontracts, which exceed \$100,000 and that all such recipients shall certify and disclose accordingly.

**ATTACHMENT A - EMPLOYMENT AND MATERIALS  
PREFERENCE FOR APPALACHIAN DEVELOPMENT  
HIGHWAY SYSTEM OR APPALACHIAN LOCAL ACCESS  
ROAD CONTRACTS**

This provision is applicable to all Federal-aid projects funded under the Appalachian Regional Development Act of 1965.

1. During the performance of this contract, the contractor undertaking to do work which is, or reasonably may be, done as on-site work, shall give preference to qualified persons who regularly reside in the labor area as designated by the DOL wherein the contract work is situated, or the subregion, or the Appalachian counties of the State wherein the contract work is situated, except:

a. To the extent that qualified persons regularly residing in the area are not available.

b. For the reasonable needs of the contractor to employ supervisory or specially experienced personnel necessary to assure an efficient execution of the contract work.

c. For the obligation of the contractor to offer employment to present or former employees as the result of a lawful collective bargaining contract, provided that the number of nonresident persons employed under this subparagraph (1c) shall not exceed 20 percent of the total number of employees employed by the contractor on the contract work, except as provided in subparagraph (4) below.

2. The contractor shall place a job order with the State Employment Service indicating (a) the classifications of the laborers, mechanics and other employees required to perform the contract work, (b) the number of employees required in each classification, (c) the date on which the participant estimates such employees will be required, and (d) any other pertinent information required by the State Employment Service to complete the job order form. The job order may be placed with the State Employment Service in writing or by telephone. If during the course of the contract work, the information submitted by the contractor in the original job order is substantially modified, the participant shall promptly notify the State Employment Service.

3. The contractor shall give full consideration to all qualified job applicants referred to him by the State Employment Service. The contractor is not required to grant employment to any job applicants who, in his opinion, are not qualified to perform the classification of work required.

4. If, within one week following the placing of a job order by the contractor with the State Employment Service, the State Employment Service is unable to refer any qualified job applicants to the contractor, or less than the number requested, the State Employment Service will forward a certificate to the contractor indicating the unavailability of applicants. Such certificate shall be made a part of the contractor's permanent project records. Upon receipt of this certificate, the contractor may employ persons who do not normally reside in the labor area to fill positions covered by the certificate, notwithstanding the provisions of subparagraph (1c) above.

5. The provisions of 23 CFR 633.207(e) allow the contracting agency to provide a contractual preference for the use of mineral resource materials native to the Appalachian region.

6. The contractor shall include the provisions of Sections 1 through 4 of this Attachment A in every subcontract for work which is, or reasonably may be, done as on-site work.

**KENTUCKY TRANSPORTATION CABINET  
DEPARTMENT OF HIGHWAYS**

**EMPLOYMENT REQUIREMENTS  
RELATING TO  
NONDISCRIMINATION OF EMPLOYEES  
(APPLICABLE TO FEDERAL-AID SYSTEM CONTRACTS)**

**AN ACT OF THE KENTUCKY GENERAL ASSEMBLY  
TO PREVENT DISCRIMINATION IN EMPLOYMENT**

**KRS CHAPTER 344  
EFFECTIVE JUNE 16, 1972**

The contract on this project, in accordance with KRS Chapter 344, provides that during the performance of this contract, the contractor agrees as follows:

1. The contractor shall not fail or refuse to hire, or shall not discharge any individual, or otherwise discriminate against an individual with respect to his compensation, terms, conditions, or privileges of employment, because of such individual's race, color, religion, national origin, sex, disability or age (forty and above); or limit, segregate, or classify his employees in any way which would deprive or tend to deprive an individual of employment opportunities or otherwise adversely affect his status as an employee, because of such individual's race, color, religion, national origin, sex, disability or age forty (40) and over. The contractor agrees to post in conspicuous places, available to employees and applicants for employment, notices to be provided setting forth the provisions of this nondiscrimination clause.

2. The contractor shall not print or publish or cause to be printed or published a notice or advertisement relating to employment by such an employer or membership in or any classification or referral for employment by the employment agency, indicating any preference, limitation, specification, or discrimination, based on race, color, religion, national origin, sex, or age forty (40) and over, or because the person is a qualified individual with a disability, except that such a notice or advertisement may indicate a preference, limitation, or specification based on religion, national origin, sex, or age forty (40) and over, or because the person is a qualified individual with a disability, when religion, national origin, sex, or age forty (40) and over, or because the person is a qualified individual with a disability, is a bona fide occupational qualification for employment.

3. If the contractor is in control of apprenticeship or other training or retraining, including on-the-job training programs, he shall not discriminate against an individual because of his race, color, religion, national origin, sex, disability or age forty (40) and over, in admission to, or employment in any program established to provide apprenticeship or other training.

4. The contractor will send to each labor union or representative of workers with which he has a collective bargaining agreement or other contract or understanding, a notice to be provided advising the said labor union or workers' representative of the contractor's commitments under this section, and shall post copies of the notice in conspicuous places available to employees and applicants for employment. The contractor will take such action with respect to any subcontract or purchase order as the administering agency may direct as a means of enforcing such provisions, including sanctions for non-compliance.

Revised: January 25, 2017

### Standard Title VI/Non-Discrimination Assurances

During the performance of this contract, the contractor, for itself, its assignees, and successors in interest (hereinafter referred to as the "contractor") agrees as follows:

1. **Compliance with Regulations:** The contractor (hereinafter includes consultants) will comply with the Acts and the Regulations relative to Non-discrimination in Federally-assisted programs of the U.S. Department of Transportation, **Federal Highway Administration**, as they may be amended from time to time, which are herein incorporated by reference and made a part of this contract.
2. **Non-discrimination:** The contractor, with regard to the work performed by it during the contract, will not discriminate on the grounds of race, color, or national origin in the selection and retention of subcontractors, including procurements of materials and leases of equipment. The contractor will not participate directly or indirectly in the discrimination prohibited by the Acts and the Regulations, including employment practices when the contract covers any activity, project, or program set forth in Appendix B of 49 CFR Part 21.
3. **Solicitations for Subcontracts, Including Procurements of Materials and Equipment:** In all solicitations, either by competitive bidding, or negotiation made by the contractor for work to be performed under a subcontract, including procurements of materials, or leases of equipment, each potential subcontractor or supplier will be notified by the contractor of the contractor's obligations under this contract and the Acts and the Regulations relative to Non-discrimination on the grounds of race, color, or national origin.
4. **Information and Reports:** The contractor will provide all information and reports required by the Acts, the Regulations, and directives issued pursuant thereto and will permit access to its books, records, accounts, other sources of information, and its facilities as may be determined by the Recipient or the **Federal Highway Administration** to be pertinent to ascertain compliance with such Acts, Regulations, and instructions. Where any information required of a contractor is in the exclusive possession of another who fails or refuses to furnish the information, the contractor will so certify to the Recipient or the **Federal Highway Administration**, as appropriate, and will set forth what efforts it has made to obtain the information.
5. **Sanctions for Noncompliance:** In the event of a contractor's noncompliance with the Non-discrimination provisions of this contract, the Recipient will impose such contract sanctions as it or the **Federal Highway Administration** may determine to be appropriate, including, but not limited to:
  - a. withholding payments to the contractor under the contract until the contractor complies; and/or
  - b. cancelling, terminating, or suspending a contract, in whole or in part.
6. **Incorporation of Provisions:** The contractor will include the provisions of paragraphs one through six in every subcontract, including procurements of materials and leases of equipment, unless exempt by the Acts, the Regulations and directives issued pursuant thereto. The contractor will take action with respect to any subcontract or procurement as the Recipient or the **Federal Highway Administration** may direct as a means of enforcing such provisions including sanctions for noncompliance. Provided, that if the contractor becomes involved in, or is threatened with litigation by a subcontractor, or supplier because of such direction, the contractor may request the Recipient to enter into any litigation to protect the interests of the Recipient. In addition, the contractor may request the United States to enter into the litigation to protect the interests of the United States.

### Standard Title VI/Non-Discrimination Statutes and Authorities

During the performance of this contract, the contractor, for itself, its assignees, and successors in interest (hereinafter referred to as the “contractor”) agrees to comply with the following non-discrimination statutes and authorities; including but not limited to:

- Title VI of the Civil Rights Act of 1964 (42 U.S.C. § 2000d *et seq.*, 78 stat. 252), (prohibits discrimination on the basis of race, color, national origin); and 49 CFR Part 21;
- The Uniform Relocation Assistance and Real Property Acquisition Policies Act of 1970, (42 U.S.C. § 4601), (prohibits unfair treatment of persons displaced or whose property has been acquired because of Federal or Federal-aid programs and projects);
- Federal-Aid Highway Act of 1973, (23 U.S.C. § 324 *et seq.*), (prohibits discrimination on the basis of sex);
- Section 504 of the Rehabilitation Act of 1973, (29 U.S.C. § 794 *et seq.*), as amended, (prohibits discrimination on the basis of disability); and 49 CFR Part 27;
- The Age Discrimination Act of 1975, as amended, (42 U.S.C. § 6101 *et seq.*), (prohibits discrimination on the basis of age);
- Airport and Airway Improvement Act of 1982, (49 USC § 471, Section 47123), as amended, (prohibits discrimination based on race, creed, color, national origin, or sex);
- The Civil Rights Restoration Act of 1987, (PL 100-209), (Broadened the scope, coverage and applicability of Title VI of the Civil Rights Act of 1964, The Age Discrimination Act of 1975 and Section 504 of the Rehabilitation Act of 1973, by expanding the definition of the terms “programs or activities” to include all of the programs or activities of the Federal-aid recipients, sub-recipients and contractors, whether such programs or activities are Federally funded or not);
- Titles II and III of the Americans with Disabilities Act, which prohibit discrimination on the basis of disability in the operation of public entities, public and private transportation systems, places of public accommodation, and certain testing entities (42 U.S.C. §§ 12131 -- 12189) as implemented by Department of Transportation regulations at 49 C.F.R. parts 37 and 38;
- The Federal Aviation Administration’s Non-discrimination statute (49 U.S.C. § 47123) (prohibits discrimination on the basis of race, color, national origin, and sex);
- Executive Order 12898, Federal Actions to Address Environmental Justice in Minority Populations and Low-Income Populations, which ensures non-discrimination against minority populations by discouraging programs, policies, and activities with disproportionately high and adverse human health or environmental effects on minority and low-income populations;
- Executive Order 13166, Improving Access to Services for Persons with Limited English Proficiency, and resulting agency guidance, national origin discrimination includes discrimination because of limited English proficiency (LEP). To ensure compliance with Title VI, you must take reasonable steps to ensure that LEP persons have meaningful access to your programs (70 Fed. Reg. at 74087 to 74100);
- Title IX of the Education Amendments of 1972, as amended, which prohibits you from discriminating because of sex in education programs or activities (20 U.S.C. 1681 *et seq.*)

## EXECUTIVE BRANCH CODE OF ETHICS

In the 1992 regular legislative session, the General Assembly passed and Governor Brereton Jones signed Senate Bill 63 (codified as KRS 11A), the Executive Branch Code of Ethics, which states, in part:

KRS 11A.040 (7) provides:

No present or former public servant shall, within six (6) months following termination of his office or employment, accept employment, compensation, or other economic benefit from any person or business that contracts or does business with, or is regulated by, the state in matters in which he was directly involved during the last thirty-six (36) months of his tenure. This provision shall not prohibit an individual from returning to the same business, firm, occupation, or profession in which he was involved prior to taking office or beginning his term of employment, or for which he received, prior to his state employment, a professional degree or license, provided that, for a period of six (6) months, he personally refrains from working on any matter in which he was directly involved during the last thirty-six (36) months of his tenure in state government. This subsection shall not prohibit the performance of ministerial functions, including but not limited to filing tax returns, filing applications for permits or licenses, or filing incorporation papers, nor shall it prohibit the former officer or public servant from receiving public funds disbursed through entitlement programs.

KRS 11A.040 (9) states:

A former public servant shall not represent a person or business before a state agency in a matter in which the former public servant was directly involved during the last thirty-six (36) months of his tenure, for a period of one (1) year after the latter of:

- a) The date of leaving office or termination of employment; or
- b) The date the term of office expires to which the public servant was elected.

This law is intended to promote public confidence in the integrity of state government and to declare as public policy the idea that state employees should view their work as a public trust and not as a way to obtain private benefits.

If you have worked for the executive branch of state government within the past six months, you may be subject to the law's prohibitions. The law's applicability may be different if you hold elected office or are contemplating representation of another before a state agency.

Also, if you are affiliated with a firm which does business with the state and which employs former state executive-branch employees, you should be aware that the law may apply to them.

In case of doubt, the law permits you to request an advisory opinion from the Executive Branch Ethics Commission, 3 Fountain Place, Frankfort, Kentucky 40601; telephone (502) 564-7954.

Revised: January 27, 2017

"General Decision Number: KY20200040 11/06/2020

Superseded General Decision Number: KY20190040

State: Kentucky

Construction Type: Highway

Counties: Allen, Ballard, Butler, Caldwell, Calloway, Carlisle, Christian, Crittenden, Daviess, Edmonson, Fulton, Graves, Hancock, Henderson, Hickman, Hopkins, Livingston, Logan, Lyon, Marshall, McCracken, McLean, Muhlenberg, Ohio, Simpson, Todd, Trigg, Union, Warren and Webster Counties in Kentucky.

HIGHWAY CONSTRUCTION PROJECTS (excluding tunnels, building structures in rest area projects & railroad construction; bascule, suspension & spandrel arch bridges designed for commercial navigation, bridges involving marine construction; and other major bridges).

Note: Under Executive Order (EO) 13658, an hourly minimum wage of \$10.80 for calendar year 2020 applies to all contracts subject to the Davis-Bacon Act for which the contract is awarded (and any solicitation was issued) on or after January 1, 2015. If this contract is covered by the EO, the contractor must pay all workers in any classification listed on this wage determination at least \$10.80 per hour (or the applicable wage rate listed on this wage determination, if it is higher) for all hours spent performing on the contract in calendar year 2020. If this contract is covered by the EO and a classification considered necessary for performance of work on the contract does not appear on this wage determination, the contractor must pay workers in that classification at least the wage rate determined through the conformance process set forth in 29 CFR 5.5(a)(1)(ii) (or the EO minimum wage rate, if it is higher than the conformed wage rate). The EO minimum wage rate will be adjusted annually. Please note that this EO applies to the above-mentioned types of contracts entered into by the federal government that are subject to the Davis-Bacon Act itself, but it does not apply to contracts subject only to the Davis-Bacon Related Acts, including those set forth at 29 CFR 5.1(a)(2)-(60). Additional information on contractor requirements and worker protections under the EO is available at [www.dol.gov/whd/govcontracts](http://www.dol.gov/whd/govcontracts).

Modification Number	Publication Date
0	01/03/2020
1	01/10/2020
2	01/31/2020
3	08/14/2020
4	08/28/2020
5	10/02/2020
6	10/23/2020
7	10/30/2020
8	11/06/2020

BRIN0004-002 06/01/2017

BALLARD, BUTLER, CALDWELL, CARLISLE, CRITTENDEN, DAVIESS, EDMONSON, FULTON, GRAVES, HANCOCK, HENDERSON, HICKMAN, HOPKINS, LIVINGSTON, LYON, MARSHALL, MCCRACKEN, MCLEAN,

MUHLENBERG, OHIO, UNION, and WEBSTER COUNTIES

	Rates	Fringes
BRICKLAYER		
Ballard, Caldwell, Carlisle, Crittenden, Fulton, Graves, Hickman, Livingston, Lyon, Marshall, and McCracken Counties.....	\$ 30.50	15.16
Butler, Edmonson, Hopkins, Muhlenberg, and Ohio Counties.....	\$ 26.80	12.38
Daviess, Hancock, Henderson, McLean, Union, and Webster Counties.....	\$ 30.00	15.16

-----  
BRTN0004-005 06/01/2017

ALLEN, CALLOWAY, CHRISTIAN, LOGAN, SIMPSON, TODD, TRIGG, and  
WARREN COUNTIES

	Rates	Fringes
BRICKLAYER.....	\$ 26.80	12.38

-----  
\* CARP0357-002 04/01/2020

	Rates	Fringes
CARPENTER.....	\$ 29.81	19.92
DIVER.....	\$ 45.09	19.92
PILEDRIVERMAN.....	\$ 30.06	19.92

-----  
ELEC0369-006 05/28/2019

BUTLER, EDMONSON, LOGAN, TODD & WARREN COUNTIES:

	Rates	Fringes
ELECTRICIAN.....	\$ 32.44	17.22

-----  
ELEC0429-001 01/01/2020

ALLEN & SIMPSON COUNTIES:

	Rates	Fringes
ELECTRICIAN.....	\$ 27.72	13.48

-----  
ELEC0816-002 06/30/2020

BALLARD, CALDWELL, CALLOWAY, CARLISLE, CHRISTIAN, CRITTENDEN,  
FULTON (Except a 5 mile radius of City Hall in Fulton), GRAVES,  
HICKMAN, LIVINGSTON, LYON, MARSHALL, MCCRACKEN & TRIGG COUNTIES:

	Rates	Fringes
ELECTRICIAN.....	\$ 34.06	25.50%+7.25

Cable spicers receive \$.25 per hour additional.

-----

ELEC1701-003 01/01/2020

DAVISS, HANCOCK, HENDERSON, HOPKINS, MCLEAN, MUHLENBERG, OHIO,  
UNION & WEBSTER COUNTIES:

	Rates	Fringes
ELECTRICIAN.....	\$ 31.52	30%+7.25

Cable spicers receive \$.25 per hour additional.

-----

ELEC1925-002 01/01/2020

FULTON COUNTY (Up to a 5 mile radius of City Hall in Fulton):

	Rates	Fringes
CABLE SPLICER.....	\$ 25.60	14.50
ELECTRICIAN.....	\$ 25.10	14.48

-----

ENGI0181-017 07/01/2020

	Rates	Fringes
POWER EQUIPMENT OPERATOR		
GROUP 1.....	\$ 33.95	17.25
GROUP 2.....	\$ 31.09	17.25
GROUP 3.....	\$ 31.54	17.25
GROUP 4.....	\$ 30.77	17.25

OPERATING ENGINEER CLASSIFICATIONS

GROUP 1 - A-Frame Winch Truck; Auto Patrol; Backfiller; Batcher Plant; Bituminous Paver; Bituminous Transfer Machine; Boom Cat; Bulldozer; Mechanic; Cableway; Carry-All Scoop; Carry Deck Crane; Central Compressor Plant; Cherry Picker; Clamshell; Concrete Mixer (21 cu. ft. or Over); Concrete Paver; Truck-Mounted Concrete Pump; Core Drill; Crane; Crusher Plant; Derrick; Derrick Boat; Ditching & Trenching Machine; Dragline; Dredge Operator; Dredge Engineer; Elevating Grader & Loaders; Grade-All; Gurries; Heavy Equipment Robotics Operator/Mechanic; High Lift; Hoe-Type Machine; Hoist (Two or More Drums); Hoisting Engine (Two or More Drums); Horizontal Directional Drill Operator; Hydrocrane; Hyster; KeCal Loader; LeTourneau; Locomotive; Mechanic; Mechanically Operated Laser Screed; Mechanic Welder; Mucking Machine; Motor Scraper; Orangepeel Bucket; Overhead Crane; Piledriver; Power Blade; Pumpcrete; Push Dozer; Rock Spreader, attached to equipment; Rotary Drill; Roller (Bituminous); Rough Terrain Crane; Scarifier; Scoopmobile; Shovel; Side Boom; Subgrader; Tailboom; Telescoping Type Forklift; Tow or Push Boat; Tower Crane (French, German & other types); Tractor Shovel; Truck Crane; Tunnel Mining Machines, including Moles, Shields or similar types of Tunnel Mining Equipment

GROUP 2 - Air Compressor (Over 900 cu. ft. per min.); Bituminous Mixer; Boom Type Tamping Machine; Bull Float; Concrete Mixer (Under 21 cu. ft.); Dredge Engineer; Electric Vibrator; Compactor/Self-Propelled Compactor; Elevator (One Drum or Buck Hoist); Elevator (When used to

Hoist Building Material); Finish Machine; Firemen & Hoist (One Drum); Flexplane; Forklift (Regardless of Lift Height); Form Grader; Joint Sealing Machine; Outboard Motor Boat; Power Sweeper (Riding Type); Roller (Rock); Ross Carrier; Skid Mounted or Trailer Mounted Concrete Pump; Skid Steer Machine with all Attachments; Switchman or Brakeman; Throttle Valve Person; Tractair & Road Widening Trencher; Tractor (50 H.P. or Over); Truck Crane Oiler; Tugger; Welding Machine; Well Points;& Whirley Oiler

GROUP 3 -All Off Road Material Handling Equipment, including Articulating Dump Trucks; Greaser on Grease Facilities servicing Heavy Equipment

GROUP 4 - Bituminous Distributor; Burlap & Curing Machine; Cement Gun; Concrete Saw; Conveyor; Deckhand Oiler; Grout Pump; Hydraulic Post Driver; Hydro Seeder; Mud Jack; Oiler; Paving Joint Machine; Power Form Handling Equipment; Pump; Roller (Earth); Steerman; Tamping Machine; Tractor (Under 50 H.P.); & Vibrator

CRANES - with booms 150 ft. & Over (Including JIB), and where the length of the boom in combination with the length of the piling equals or exceeds 150 ft. - \$1.00 above Group 1 rate

EMPLOYEES ASSIGNED TO WORK BELOW GROUND LEVEL ARE TO BE PAID 10% ABOVE BASIC WAGE RATE. THIS DOES NOT APPLY TO OPEN CUT WORK.

-----  
IRON0070-005 06/01/2020

BUTLER COUNTY (Eastern eighth, including the Townships of Decker, Lee & Tilford);  
EDMONSON COUNTY (Northern three-fourths, including the Townships of Asphalt, Bee Spring, Brownsville, Grassland, Huff, Kyrock, Lindseyville, Mammoth Cave, Ollie, Prosperity, Rhoda, Sunfish & Sweden)

Rates Fringes

IRONWORKER

Structural; Ornamental;  
Reinforcing; Precast  
Concrete Erectors.....\$ 30.42 23.15

-----  
IRON0103-004 08/01/2018

DAVISS, HANCOCK, HENDERSON, HOPKINS, MCLEAN, OHIO, UNION & WEBSTER COUNTIES  
BUTLER COUNTY (Townships of Aberdeen, Bancock, Casey, Dexterville, Dunbar, Elfie, Gilstrap, Huntsville, Logansport, Monford, Morgantown, Provo, Rochester, South Hill & Welchs Creek);  
CALDWELL COUNTY (Northeastern third, including the Township of Creswell);  
CHRISTIAN COUNTY (Northern third, including the Townships of Apex, Crofton, Kelly, Mannington & Wynns);  
CRITTENDEN COUNTY (Northeastern half, including the Townships of Grove, Mattoon, Repton, Shady Grove & Tribune);  
MUHLENBERG COUNTY (Townships of Bavier, Beech Creek Junction, Benton, Brennen, Browder, Central City, Cleaton, Depoy,

Drakesboro, Eunis, Graham, Hillside, Luzerne, Lynn City,  
Martwick, McNary, Millport, Moorman, Nelson, Paradise,  
Powderly, South Carrollton, Tarina & Weir)

	Rates	Fringes
Ironworkers:.....	\$ 28.66	22.435
-----		
IRON0492-003 05/01/2018		

ALLEN, LOGAN, SIMPSON, TODD & WARREN COUNTIES  
 BUTLER COUNTY (Southern third, including the Townships of  
 Boston, Berrys Lick, Dimple, Jetson, Quality, Sharer, Sugar  
 Grove & Woodbury);  
 CHRISTIAN COUNTY (Eastern two-thirds, including the Townships  
 of Bennettstown, Casky, Herndon, Hopkinsville, Howell,  
 Masonville, Pembroke & Thompsonville);  
 EDMONSON COUNTY (Southern fourth, including the Townships of  
 Chalybeate & Rocky Hill);  
 MUHLENBERG COUNTY (Southern eighth, including the Townships of  
 Dunnior, Penrod & Rosewood)

	Rates	Fringes
Ironworkers:.....	\$ 26.11	14.02
-----		
IRON0782-006 05/01/2018		

BALLARD, CALLOWAY, CARLISLE, FULTON, GRAVES, HICKMAN,  
 LIVINGSTON, LYON, MARSHALL, MCCRACKEN & TRIGG COUNTIES  
 CALDWELL COUNTY (Southwestern two-thirds, including the  
 Townships of Cedar Bluff, Cider, Claxton, Cobb, Crowtown,  
 Dulaney, Farmersville, Fredonia, McGowan, Otter Pond &  
 Princeton);  
 CHRISTIAN COUNTY (Western third, Excluding the Townships of  
 Apex, Crofton, Kelly, Mannington, Wynns, Bennettstown, Casky,  
 Herndon, Hopkinsville, Howell, Masonville, Pembroke &  
 Thompsonville);  
 CRITTENDEN COUNTY (Southwestern half, including the Townships  
 of Crayne, Dycusburg, Frances, Marion, Mexico, Midway,  
 Sheridan & Told)

	Rates	Fringes
Ironworkers:		
Projects with a total contract cost of \$20,000,000.00 or above.....	\$ 28.79	24.17
All Other Work.....	\$ 27.20	22.75
-----		
LABO0189-005 07/01/2020		

BALLARD, CALLOWAY, CARLISLE, FULTON, GRAVES, HICKMAN,  
LIVINGSTON, LYON, MARSHALL & MCCRACKEN COUNTIES

	Rates	Fringes
Laborers:		
GROUP 1.....	\$ 23.26	15.62
GROUP 2.....	\$ 23.51	15.62

GROUP 3.....	\$ 23.56	15.62
GROUP 4.....	\$ 24.16	15.62

LABORER CLASSIFICATIONS

GROUP 1 - Aging & Curing of Concrete; Asbestos Abatement Worker; Asphalt Plant; Asphalt; Batch Truck Dump; Carpenter Tender; Cement Mason Tender; Cleaning of Machines; Concrete; Demolition; Dredging; Environmental - Nuclear, Radiation, Toxic & Hazardous Waste - Level D; Flagperson; Grade Checker; Hand Digging & Hand Back Filling; Highway Marker Placer; Landscaping, Mesh Handler & Placer; Puddler; Railroad; Rip-rap & Grouter; Right-of-Way; Sign, Guard Rail & Fence Installer; Signal Person; Sound Barrier Installer; Storm & Sanitary Sewer; Swamper; Truck Spotter & Dumper; Wrecking of Concrete Forms; General Cleanup

GROUP 2 - Batter Board Man (Sanitary & Storm Sewer); Brickmason Tender; Mortar Mixer Operator; Scaffold Builder; Burner & Welder; Bushhammer; Chain Saw Operator; Concrete Saw Operator; Deckhand Scow Man; Dry Cement Handler; Environmental - Nuclear, Radiation, Toxic & Hazardous Waste - Level C; Forklift Operator for Masonary; Form Setter; Green Concrete Cutting; Hand Operated Grouter & Grinder Machine Operator; Jackhammer; Pavement Breaker; Paving Joint Machine; Pipelayer; Plastic Pipe Fusion; Power Driven Georgia Buggy & Wheel Barrow; Power Post Hole Digger; Precast Manhole Setter; Walk-Behind Tamper; Walk-Behind Trencher; Sand Blaster; Concrete Chipper; Surface Grinder; Vibrator Operator; Wagon Driller

GROUP 3 - Asphalt Luteman & Raker; Gunnite Nozzleman; Gunnite Operator & Mixer; Grout Pump Operator; Blaster; Side Rail Setter; Rail Paved Ditches; Screw Operator; Tunnel (Free Air); Water Blaster

GROUP 4 - Caisson Worker (Free Air); Cement Finisher; Environmental - Nuclear, Radiation, Toxic & Hazardous Waste - Levels A & B; Miner & Driller (Free Air); Tunnel Blaster; & Tunnel Mucker (Free Air); Directional & Horizontal Boring; Air Track Drillers (All Types); Powdermen & Blasters; Troxler & Concrete Tester if Laborer is Utilized

-----  
LABO0189-006 07/01/2020

ALLEN, BUTLER, CALDWELL, CHRISTIAN, DAVIESS, EDMONSON, HANCOCK, HOPKINS, LOGAN, MCLEAN, MUHLENBERG, OHIO, SIMPSON, TODD, TRIGG & WARREN COUNTIES

	Rates	Fringes
Laborers:		
GROUP 1.....	\$ 23.26	15.62
GROUP 2.....	\$ 23.51	15.62
GROUP 3.....	\$ 23.56	15.62
GROUP 4.....	\$ 24.16	15.62

LABORER CLASSIFICATIONS

GROUP 1 - Aging & Curing of Concrete; Asbestos Abatement Worker; Asphalt Plant; Asphalt; Batch Truck Dump; Carpenter Tender; Cement Mason Tender; Cleaning of Machines;

Concrete; Demolition; Dredging; Environmental - Nuclear, Radiation, Toxic & Hazardous Waste - Level D; Flagperson; Grade Checker; Hand Digging & Hand Back Filling; Highway Marker Placer; Landscaping, Mesh Handler & Placer; Puddler; Railroad; Rip-rap & Grouter; Right-of-Way; Sign, Guard Rail & Fence Installer; Signal Person; Sound Barrier Installer; Storm & Sanitary Sewer; Swamper; Truck Spotter & Dumper; Wrecking of Concrete Forms; General Cleanup

GROUP 2 - Batter Board Man (Sanitary & Storm Sewer); Brickmason Tender; Mortar Mixer Operator; Scaffold Builder; Burner & Welder; Bushhammer; Chain Saw Operator; Concrete Saw Operator; Deckhand Scow Man; Dry Cement Handler; Environmental - Nuclear, Radiation, Toxic & Hazardous Waste - Level C; Forklift Operator for Masonary; Form Setter; Green Concrete Cutting; Hand Operated Grouter & Grinder Machine Operator; Jackhammer; Pavement Breaker; Paving Joint Machine; Pipelayer; Plastic Pipe Fusion; Power Driven Georgia Buggy & Wheel Barrow; Power Post Hole Digger; Precast Manhole Setter; Walk-Behind Tamper; Walk-Behind Trencher; Sand Blaster; Concrete Chipper; Surface Grinder; Vibrator Operator; Wagon Driller

GROUP 3 - Asphalt Luteman & Raker; Gunnite Nozzleman; Gunnite Operator & Mixer; Grout Pump Operator; Blaster; Side Rail Setter; Rail Paved Ditches; Screw Operator; Tunnel (Free Air); Water Blaster

GROUP 4 - Caisson Worker (Free Air); Cement Finisher; Environmental - Nuclear, Radiation, Toxic & Hazardous Waste - Levels A & B; Miner & Driller (Free Air); Tunnel Blaster; & Tunnel Mucker (Free Air); Directional & Horizontal Boring; Air Track Drillers (All Types); Powdermen & Blasters; Troxler & Concrete Tester if Laborer is Utilized

-----  
LABO0561-001 07/01/2020

CRITTENDEN, HENDERSON, UNION & WEBSTER COUNTIES

	Rates	Fringes
Laborers:		
GROUP 1.....	\$ 23.66	16.10
GROUP 2.....	\$ 23.91	16.10
GROUP 3.....	\$ 23.96	16.10
GROUP 4.....	\$ 24.56	16.10

LABORER CLASSIFICATIONS

GROUP 1 - Aging & Curing of Concrete; Asbestos Abatement Worker; Asphalt Plant; Asphalt; Batch Truck Dump; Carpenter Tender; Cement Mason Tender; Cleaning of Machines; Concrete; Demolition; Dredging; Environmental - Nuclear, Radiation, Toxic & Hazardous Waste - Level D; Flagperson; Grade Checker; Hand Digging & Hand Back Filling; Highway Marker Placer; Landscaping, Mesh Handler & Placer; Puddler; Railroad; Rip-rap & Grouter; Right-of-Way; Sign, Guard Rail & Fence Installer; Signal Person; Sound Barrier Installer; Storm & Sanitary Sewer; Swamper; Truck Spotter & Dumper; Wrecking of Concrete Forms; General Cleanup

GROUP 2 - Batter Board Man (Sanitary & Storm Sewer); Brickmason Tender; Mortar Mixer Operator; Scaffold Builder;

Burner & Welder; Bushhammer; Chain Saw Operator; Concrete Saw Operator; Deckhand Scow Man; Dry Cement Handler; Environmental - Nuclear, Radiation, Toxic & Hazardous Waste - Level C; Forklift Operator for Masonary; Form Setter; Green Concrete Cutting; Hand Operated Grouter & Grinder Machine Operator; Jackhammer; Pavement Breaker; Paving Joint Machine; Pipelayer; Plastic Pipe Fusion; Power Driven Georgia Buggy & Wheel Barrow; Power Post Hole Digger; Precast Manhole Setter; Walk-Behind Tamper; Walk-Behind Trencher; Sand Blaster; Concrete Chipper; Surface Grinder; Vibrator Operator; Wagon Driller

GROUP 3 - Asphalt Luteman & Raker; Gunnite Nozzleman; Gunnite Operator & Mixer; Grout Pump Operator; Blaster; Side Rail Setter; Rail Paved Ditches; Screw Operator; Tunnel (Free Air); Water Blaster

GROUP 4 - Caisson Worker (Free Air); Cement Finisher; Environmental - Nuclear, Radiation, Toxic & Hazardous Waste - Levels A & B; Miner & Driller (Free Air); Tunnel Blaster; & Tunnel Mucker (Free Air); Directional & Horizontal Boring; Air Track Drillers (All Types); Powdermen & Blasters; Troxler & Concrete Tester if Laborer is Utilized

-----  
PAIN0032-002 09/01/2020

BALLARD COUNTY

	Rates	Fringes
Painters:		
Bridges.....	\$ 35.01	17.93
All Other Work.....	\$ 32.71	17.93
Spray, Blast, Steam, High & Hazardous (Including Lead Abatement) and All Epoxy - \$1.00 Premium		

-----  
PAIN0118-003 06/01/2014

EDMONSON COUNTY:

	Rates	Fringes
Painters:		
Brush & Roller.....	\$ 18.50	11.97
Spray, Sandblast, Power Tools, Waterblast & Steam Cleaning.....	\$ 19.50	11.97

-----  
PAIN0156-006 04/01/2015

DAVISS, HANCOCK, HENDERSON, MCLEAN, OHIO, UNION & WEBSTER COUNTIES

	Rates	Fringes
Painters:		
BRIDGES		
GROUP 1.....	\$ 27.60	12.85
GROUP 2.....	\$ 27.85	12.85
GROUP 3.....	\$ 28.60	12.85

GROUP 4.....	\$ 29.60	12.85
ALL OTHER WORK:		
GROUP 1.....	\$ 26.45	12.85
GROUP 2.....	\$ 26.70	12.85
GROUP 3.....	\$ 27.45	12.85
GROUP 4.....	\$ 28.45	12.85

PAINTER CLASSIFICATIONS

GROUP 1 - Brush & Roller

GROUP 2 - Plasterers

GROUP 3 - Spray; Sandblast; Power Tools; Waterblast;  
Steamcleaning; Brush & Roller of Mastics, Creosotes, Kwinch  
Koate & Coal Tar Epoxy

GROUP 4 - Spray of Mastics, Creosotes, Kwinch Koate & Coal  
Tar Epoxy

-----  
PAIN0500-002 06/01/2020

CALDWELL, CALLOWAY, CARLISLE, CHRISTIAN, CRITTENDEN, FULTON,  
GRAVES, HICKMAN, HOPKINS, LIVINGSTON, LYON, MARSHALL, MCCRACKEN  
& TRIGG COUNTIES:

	Rates	Fringes
Painters:		
Bridges.....	\$ 27.75	15.10
All Other Work.....	\$ 21.50	15.10

Waterblasting units with 3500 PSI and above - \$.50 premium  
Spraypainting and all abrasive blasting - \$1.00 premium  
Work 40 ft. and above ground level - \$1.00 premium

-----  
PLUM0184-002 07/01/2018

BALLARD, CALDWELL, CALLOWAY, CARLISLE, CHRISTIAN, CRITTENDEN,  
FULTON, GRAVES, HICKMAN, LIVINGSTON, LYON, MARSHALL, MCCRACKEN  
and TRIGG COUNTIES

	Rates	Fringes
Plumber; Steamfitter.....	\$ 35.06	18.18

-----  
PLUM0502-004 08/01/2020

ALLEN, BUTLER, EDMONSON, SIMPSON & WARREN

	Rates	Fringes
Plumber; Steamfitter.....	\$ 36.92	20.78

-----  
PLUM0633-002 07/01/2020

DAVISS, HANCOCK, HENDERSON, HOPKINS, LOGAN, MCLEAN,  
MUHLENBERG, OHIO, TODD, UNION & WEBSTER COUNTIES:

	Rates	Fringes
PLUMBER/PIPEFITTER.....	\$ 32.17	19.30

-----  
\* TEAM0089-003 04/01/2020

ALLEN, BUTLER, EDMONSON, LOGAN, SIMPSON & WARREN COUNTIES

	Rates	Fringes
Truck drivers:		
Zone 1:		
Group 1.....	\$ 20.82	23.49
Group 2.....	\$ 21.00	23.49
Group 3.....	\$ 21.08	23.49
Group 4.....	\$ 21.10	23.49

GROUP 1 - Greaser; Tire Changer

GROUP 2 - Truck Mechanic; Single Axle Dump; Flat Bed; All Terrain Vehicles when used to haul materials; Semi Trailer or Pole Trailer when used to pull building materials and equipment; Tandem Axle Dump; Driver of Distributors

GROUP 3 - Mixer All Types

GROUP 4 - Winch and A-Frame when used in transporting materials; Ross Carrier; Fork Lift when used to transport building materials; Driver on Pavement Breaker; Euclid and Other Heavy Earth Moving Equipment; Low Boy; Articulator Cat; Five Axle Vehicle

-----  
\* TEAM0215-003 04/01/2020

DAVISS, HANCOCK, HENDERSON, HOPKINS, MCLEAN, MUHLENBERG, OHIO & WEBSTER COUNTIES

	Rates	Fringes
TRUCK DRIVER		
Group 1.....	\$ 22.45	23.49
Group 2.....	\$ 22.68	23.49
Group 3.....	\$ 22.75	23.49
Group 4.....	\$ 22.76	23.49

GROUP 1: Greaser, Tire Changer

GROUP 2: Truck Mechanic

GROUP 3: Single Axle Dump; Flat Bed; All Terrain Vehicle when used to haul materials; Semi Trailer or Pole Trailer when used to pull building materials and equipment; Tandem Axle Dump; Driver of Distributors; Mixer All Types

GROUP 4: Euclid and other heavy earth moving equipment; Low Boy; Articulator Cat; 5 Axle Vehicle; Winch and A- Frame when used in transporting materials; Ross Carrier; Fork Lift when used to transport building materials; Driver on Pavement Breaker

-----  
\* TEAM0236-001 04/01/2020

BALLARD, CALDWELL, CALLOWAY, CARLISLE, CHRISTIAN, CRITTENDEN,  
FULTON, GRAVES, HICKMAN, LIVINGSTON, LYON, MARSHALL,  
MCCRACKEN, TODD & TRIGG COUNTIES

	Rates	Fringes
TRUCK DRIVER		
Group 1.....	\$ 20.82	23.49
Group 2.....	\$ 21.00	23.49
Group 3.....	\$ 21.00	23.49
Group 4.....	\$ 21.00	23.49
Group 5.....	\$ 21.08	23.49

GROUP 1: Greaser, Tire Changer

GROUP 2: Truck Mechanic

GROUP 3: Single Axle Dump; Flat Bed; All Terrain Vehicle when used to haul materials; Semi Trailer or Pole Trailer when used to pull building materials and equipment; Tandem Axle Dump; Drivers of Distributors

GROUP 4: Euclid and other heavy earth moving equipment; Low Boy; Articulator Cat; Five Axle Vehicle; Winch and A-Frame when used in transporting materials; Ross Carrier

GROUP 5: Mixer All Types

-----  
WELDERS - Receive rate prescribed for craft performing operation to which welding is incidental.

=====  
Note: Executive Order (EO) 13706, Establishing Paid Sick Leave for Federal Contractors applies to all contracts subject to the Davis-Bacon Act for which the contract is awarded (and any solicitation was issued) on or after January 1, 2017. If this contract is covered by the EO, the contractor must provide employees with 1 hour of paid sick leave for every 30 hours they work, up to 56 hours of paid sick leave each year. Employees must be permitted to use paid sick leave for their own illness, injury or other health-related needs, including preventive care; to assist a family member (or person who is like family to the employee) who is ill, injured, or has other health-related needs, including preventive care; or for reasons resulting from, or to assist a family member (or person who is like family to the employee) who is a victim of, domestic violence, sexual assault, or stalking. Additional information on contractor requirements and worker protections under the EO is available at [www.dol.gov/whd/govcontracts](http://www.dol.gov/whd/govcontracts).

Unlisted classifications needed for work not included within the scope of the classifications listed may be added after award only as provided in the labor standards contract clauses (29CFR 5.5 (a) (1) (ii)).

The body of each wage determination lists the classification and wage rates that have been found to be prevailing for the cited type(s) of construction in the area covered by the wage determination. The classifications are listed in alphabetical order of ""identifiers"" that indicate whether the particular rate is a union rate (current union negotiated rate for local), a survey rate (weighted average rate) or a union average rate (weighted union average rate).

#### Union Rate Identifiers

A four letter classification abbreviation identifier enclosed in dotted lines beginning with characters other than ""SU"" or ""UAVG"" denotes that the union classification and rate were prevailing for that classification in the survey. Example: PLUM0198-005 07/01/2014. PLUM is an abbreviation identifier of the union which prevailed in the survey for this classification, which in this example would be Plumbers. 0198 indicates the local union number or district council number where applicable, i.e., Plumbers Local 0198. The next number, 005 in the example, is an internal number used in processing the wage determination. 07/01/2014 is the effective date of the most current negotiated rate, which in this example is July 1, 2014.

Union prevailing wage rates are updated to reflect all rate changes in the collective bargaining agreement (CBA) governing this classification and rate.

#### Survey Rate Identifiers

Classifications listed under the ""SU"" identifier indicate that no one rate prevailed for this classification in the survey and the published rate is derived by computing a weighted average rate based on all the rates reported in the survey for that classification. As this weighted average rate includes all rates reported in the survey, it may include both union and non-union rates. Example: SULA2012-007 5/13/2014. SU indicates the rates are survey rates based on a weighted average calculation of rates and are not majority rates. LA indicates the State of Louisiana. 2012 is the year of survey on which these classifications and rates are based. The next number, 007 in the example, is an internal number used in producing the wage determination. 5/13/2014 indicates the survey completion date for the classifications and rates under that identifier.

Survey wage rates are not updated and remain in effect until a new survey is conducted.

#### Union Average Rate Identifiers

Classification(s) listed under the UAVG identifier indicate that no single majority rate prevailed for those classifications; however, 100% of the data reported for the classifications was union data. EXAMPLE: UAVG-OH-0010 08/29/2014. UAVG indicates that the rate is a weighted union average rate. OH indicates the state. The next number, 0010 in the example, is an internal number used in producing the wage determination. 08/29/2014 indicates the survey completion date for the classifications and rates under that identifier.

A UAVG rate will be updated once a year, usually in January of each year, to reflect a weighted average of the current negotiated/CBA rate of the union locals from which the rate is

based.

-----  
WAGE DETERMINATION APPEALS PROCESS

1.) Has there been an initial decision in the matter? This can be:

- \* an existing published wage determination
- \* a survey underlying a wage determination
- \* a Wage and Hour Division letter setting forth a position on a wage determination matter
- \* a conformance (additional classification and rate) ruling

On survey related matters, initial contact, including requests for summaries of surveys, should be with the Wage and Hour Regional Office for the area in which the survey was conducted because those Regional Offices have responsibility for the Davis-Bacon survey program. If the response from this initial contact is not satisfactory, then the process described in 2.) and 3.) should be followed.

With regard to any other matter not yet ripe for the formal process described here, initial contact should be with the Branch of Construction Wage Determinations. Write to:

Branch of Construction Wage Determinations  
Wage and Hour Division  
U.S. Department of Labor  
200 Constitution Avenue, N.W.  
Washington, DC 20210

2.) If the answer to the question in 1.) is yes, then an interested party (those affected by the action) can request review and reconsideration from the Wage and Hour Administrator (See 29 CFR Part 1.8 and 29 CFR Part 7). Write to:

Wage and Hour Administrator  
U.S. Department of Labor  
200 Constitution Avenue, N.W.  
Washington, DC 20210

The request should be accompanied by a full statement of the interested party's position and by any information (wage payment data, project description, area practice material, etc.) that the requestor considers relevant to the issue.

3.) If the decision of the Administrator is not favorable, an interested party may appeal directly to the Administrative Review Board (formerly the Wage Appeals Board). Write to:

Administrative Review Board  
U.S. Department of Labor  
200 Constitution Avenue, N.W.  
Washington, DC 20210

4.) All decisions by the Administrative Review Board are final.

=====  
END OF GENERAL DECISION"

Fringe benefit amounts are applicable for all hours worked except when otherwise noted.

No laborer, workman or mechanic shall be paid at a rate less than that of a Journeyman except those classified as bona fide apprentices.

Apprentices or trainees shall be permitted to work as such subject to Administrative Regulations adopted by the Commissioner of Workplace Standards. Copies of these regulations will be furnished upon request from any interested person.

Before using apprentices on the job the contractor shall present to the Contracting Officer written evidence of registration of such employees in a program of a State apprenticeship and training agency approved and recognized by the U. S. Bureau of Apprenticeship and Training. In the absence of such a State agency, the contractor shall submit evidence of approval and registration by the U. S. Bureau of Apprenticeship and Training.

The contractor shall submit to the Contracting Officer, written evidence of the established apprenticeship-journeyman ratios and wage rates in the project area, which will be the basis for establishing such ratios and rates for the project under the applicable contract provisions.

**TO: EMPLOYERS/EMPLOYEES**

**PREVAILING WAGE SCHEDULE:**

**The wages indicated on this wage schedule are the least permitted to be paid for the occupations indicated. When an employee works in more than one classification, the employer must record the number of hours worked in each classification at the prescribed hourly base rate.**

**OVERTIME:**

**Overtime is to be paid to an employee at a rate not less than one and one-half times the basic rate of pay for all hours worked in excess of forty (40) hours in such workweek. Wage violations or questions should be directed to the designated Engineer or the undersigned.**

Director  
Division of Construction Procurement  
Frankfort, Kentucky 40622  
502-564-3500

**NOTICE OF REQUIREMENT FOR AFFIRMATIVE ACTION  
TO ENSURE EQUAL EMPLOYMENT OPPORTUNITY  
(Executive Order 11246)**

1. The Offeror's or Bidder's attention is called to the "Equal Opportunity Clause" and the "Standard Federal Equal Employment Specifications" set forth herein.
2. The goals and timetables for minority and female participation, expressed in percentage terms for the Contractor's aggregate work force in each trade on all construction work in the covered area, are as follows:

<b>GOALS FOR MINORITY PARTICIPATION IN EACH TRADE</b>	<b>GOALS FOR FEMALE PARTICIPATION IN EACH TRADE</b>
12.0%	6.9%

These goals are applicable to all the Contractor's construction work (whether or not it is Federal or federally-assisted) performed in the covered area. If the contractor performs construction work in a geographical area located outside of the covered area, it shall apply the goals established for such geographical area where the work is actually performed. With regard to this second area, the contractor also is subject to the goals for both its federally involved and non-federally involved construction.

The Contractor's compliance with the Executive Order and the regulations in CFR Part 60-4 shall be based on its implementation of the Equal Opportunity Clause, specific affirmative action obligations required by the specifications set forth in 41 CFR 60-4, 3(a), and its efforts to meet the goals. The hours of minority and female employment and training must be substantially uniform throughout the length of the contract, and in each trade, and the contractor shall make a good faith effort to employ minorities and women evenly on each of its projects. The transfer of minority or female employees or trainees from Contractor to Contractor or from project to project for the sole purpose of meeting the Contractor's goals shall be a violation of the contract, the Executive Order and the regulations in 41 CFR Part 60-4. Compliance with the goals will be measured against the total work hours performed.

3. The Contractor shall provide written notification to the Director of the Office of Federal Contract Compliance Programs within ten (10) working days of award of any construction subcontract in excess of \$10,000.00 at any tier for construction work under the contract resulting from this solicitation. The notification shall list the name, address and telephone number of the subcontractor; employer identification number of the subcontractor; estimated dollar amount of the subcontract; estimated starting and completion dates of the subcontract; and the geographical area in which the subcontract is to be performed. The notification shall be mailed to:

**Evelyn Teague, Regional Director  
Office of Federal Contract Compliance Programs  
61 Forsyth Street, SW, Suite 7B75  
Atlanta, Georgia 30303-8609**

4. As used in this Notice, and in the contract resulting from this solicitation, the "**covered area**" is Warren County.

**PART IV**  
**INSURANCE**

Refer to  
*Kentucky Standard Specifications for Road and Bridge Construction,*  
current edition

**PART V**  
**BID ITEMS**

### PROPOSAL BID ITEMS

201033

Page 1 of 2

Report Date 10/27/20

#### Section: 0001 - PAVING

LINE	BID CODE	ALT	DESCRIPTION	QUANTITY	UNIT	UNIT PRIC	FP	AMOUNT
0010	00001		DGA BASE	93.00	TON		\$	
0020	00078		CRUSHED AGGREGATE SIZE NO 2	1,264.00	TON		\$	
0030	00100		ASPHALT SEAL AGGREGATE	1,121.00	TON		\$	
0040	00103		ASPHALT SEAL COAT	135.00	TON		\$	
0050	00194		LEVELING & WEDGING PG76-22	2,235.00	TON		\$	
0060	00336		CL3 ASPH SURF 0.38A PG76-22	2,696.00	TON		\$	
0070	00342		CL4 ASPH SURF 0.38A PG76-22	52,426.00	TON		\$	
0080	02677		ASPHALT PAVE MILLING & TEXTURING	55,122.00	TON		\$	
0090	20071EC		JOINT ADHESIVE	268,061.00	LF		\$	
0100	24878EC		ASPHALT EMULSION FOR FOG SEAL	142.00	TON		\$	
0110	24970EC		ASPHALT MATERIAL FOR TACK NON-TRACKING	212.00	TON		\$	
0120	24986EC		HMA ELECTRONIC DELIVERY MGMT SYSTEM	1.00	L S		\$	

#### Section: 0002 - ROADWAY

LINE	BID CODE	ALT	DESCRIPTION	QUANTITY	UNIT	UNIT PRIC	FP	AMOUNT
0130	01982		DELINEATOR FOR GUARDRAIL MONO DIRECTIONAL WHITE	5.00	EACH		\$	
0140	01985		DELINEATOR FOR BARRIER - YELLOW	300.00	EACH		\$	
0150	02003		RELOCATE TEMP CONC BARRIER	7,000.00	LF		\$	
0160	02165		REMOVE PAVED DITCH	2,172.00	SQYD		\$	
0170	02351		GUARDRAIL-STEEL W BEAM-S FACE	343.00	LF		\$	
0180	02367		GUARDRAIL END TREATMENT TYPE 1	1.00	EACH		\$	
0190	02369		GUARDRAIL END TREATMENT TYPE 2A	1.00	EACH		\$	
0200	02381		REMOVE GUARDRAIL	404.00	LF		\$	
0210	02483		CHANNEL LINING CLASS II	497.00	TON		\$	
0220	02562		TEMPORARY SIGNS	4,000.00	SQFT		\$	
0230	02575		DITCHING AND SHOULDERING	77,215.00	LF		\$	
0240	02650		MAINTAIN & CONTROL TRAFFIC	1.00	LS		\$	
0250	02671		PORTABLE CHANGEABLE MESSAGE SIGN	4.00	EACH		\$	
0260	02676		MOBILIZATION FOR MILL & TEXT	1.00	LS		\$	
0270	02696		SHOULDER RUMBLE STRIPS	250,896.00	LF		\$	
0280	02726		STAKING	1.00	LS		\$	
0290	02775		ARROW PANEL	6.00	EACH		\$	
0300	02898		RELOCATE CRASH CUSHION	35.00	EACH		\$	
0310	03171		CONCRETE BARRIER WALL TYPE 9T	2,000.00	LF		\$	
0320	03240		BASE FAILURE REPAIR	1,440.00	SQYD		\$	
0330	04904		BARRIER MOUNTING BRACKET	5.00	EACH		\$	
0340	05950		EROSION CONTROL BLANKET	60,000.00	SQYD		\$	
0350	06407		SBM ALUM SHEET SIGNS .125 IN	870.00	SQFT		\$	
0360	06511		PAVE STRIPING-TEMP PAINT-6 IN	304,810.00	LF		\$	
0370	06542		PAVE STRIPING-THERMO-6 IN W	194,980.00	LF		\$	
0380	06543		PAVE STRIPING-THERMO-6 IN Y	125,178.00	LF		\$	
0390	06546		PAVE STRIPING-THERMO-12 IN W	5,216.00	LF		\$	
0400	06549		PAVE STRIPING-TEMP REM TAPE-B	1,700.00	LF		\$	

### PROPOSAL BID ITEMS

201033

Page 2 of 2

Report Date 10/27/20

LINE	BID CODE	ALT	DESCRIPTION	QUANTITY	UNIT	UNIT PRIC	FP	AMOUNT
0410	06550		PAVE STRIPING-TEMP REM TAPE-W	3,600.00	LF		\$	
0420	06551		PAVE STRIPING-TEMP REM TAPE-Y	1,700.00	LF		\$	
0430	06574		PAVE MARKING-THERMO CURV ARROW	12.00	EACH		\$	
0440	06578		PAVE MARKING-THERMO MERGE ARROW	6.00	EACH		\$	
0450	08903		CRASH CUSHION TY VI CLASS BT TL3	10.00	EACH		\$	
0460	10020NS		FUEL ADJUSTMENT	89,279.00	DOLL	\$1.00	\$	\$89,279.00
0470	10030NS		ASPHALT ADJUSTMENT	224,243.00	DOLL	\$1.00	\$	\$224,243.00
0480	20366NN		REPLACE GRATE	28.00	EACH		\$	
0490	20757ED		PAVEMENT REPAIR	1,105.00	SQYD		\$	
0500	22520EN		PAVE MARKING-THERMO YIELD BAR-36 IN	32.00	LF		\$	
0510	24489EC		INLAID PAVEMENT MARKER	3,716.00	EACH		\$	
0520	24631EC		BARCODE SIGN INVENTORY	116.00	EACH		\$	
0530	24640ED		OBJECT MARKER TYPE 1	10.00	EACH		\$	

#### Section: 0003 - TRAFFIC LOOPS

LINE	BID CODE	ALT	DESCRIPTION	QUANTITY	UNIT	UNIT PRIC	FP	AMOUNT
0540	04793		CONDUIT-1 1/4 IN	200.00	LF		\$	
0550	04795		CONDUIT-2 IN	140.00	LF		\$	
0560	04820		TRENCHING AND BACKFILLING	320.00	LF		\$	
0570	04829		PIEZOELECTRIC SENSOR	26.00	EACH		\$	
0580	04830		LOOP WIRE	15,050.00	LF		\$	
0590	04895		LOOP SAW SLOT AND FILL	2,030.00	LF		\$	
0600	20359NN		GALVANIZED STEEL CABINET	4.00	EACH		\$	
0610	20360ES818		WOOD POST	8.00	EACH		\$	
0620	20391NS835		ELECTRICAL JUNCTION BOX TYPE A	9.00	EACH		\$	

#### Section: 0004 - DEMOBILIZATION AND/OR MOBILIZATION

LINE	BID CODE	ALT	DESCRIPTION	QUANTITY	UNIT	UNIT PRIC	FP	AMOUNT
0630	02568		MOBILIZATION	1.00	LS		\$	
0640	02569		DEMOBILIZATION	1.00	LS		\$	